

Bipolar Transistor

**(-)50 V, (-)3 A, Low $V_{CE(sat)}$,
(PNP) NPN Single PCP**

2SA2125, 2SC5964

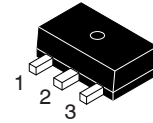

1. Base
2. Collector
3. Emitter

SOT-89 / PCP-1
CASE 419AU

Features

- Adoption of MBIT Processes
- Low Collector to Emitter Saturation Voltage
- Large Current Capacity
- High-Speed Switching
- Halogen Free Compliance

Applications

- DC-DC Converter, Relay Drivers, Lamp Drivers, Motor Drivers, Flash

Specifications

(): 2SA2125

ABSOLUTE MAXIMUM RATINGS ($T_A = 25^\circ\text{C}$)

Symbol	Parameter	Conditions	Ratings	Unit
V_{CBO}	Collector to Base Voltage	-	(-50)100	V
V_{CES}	Collector to Emitter Voltage	-	(-50)100	V
V_{CEO}	Collector to Emitter Voltage	-	(-)50	V
V_{EBO}	Emitter to Base Voltage	-	(-)6	V
I_C	Collector Current	-	(-)3	A
I_{CP}	Collector Current (Pulse)	-	(-)6	A
I_B	Base Current	-	(-)600	mA
P_C	Collector Dissipation	When mounted on ceramic substrate (250 mm ² x 0.8 mm)	1.3	W
		$T_C = 25^\circ\text{C}$	3.5	W
T_j	Junction Temperature	-	150	$^\circ\text{C}$
T_{stg}	Storage Temperature	-	-55 to +150	$^\circ\text{C}$

Stresses exceeding those listed in the Maximum Ratings table may damage the device. If any of these limits are exceeded, device functionality should not be assumed, damage may occur and reliability may be affected.

ELECTRICAL CONNECTIONS

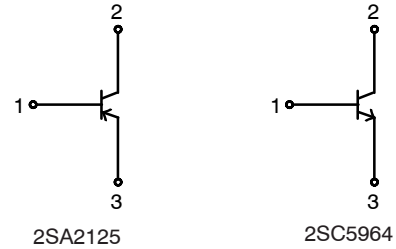

MARKING DIAGRAMS

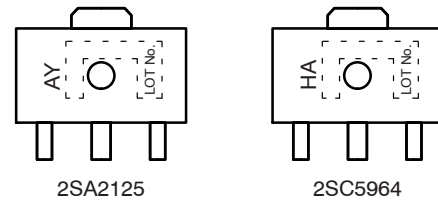

AY/HA = Specific Device Code

ORDERING INFORMATION

See detailed ordering and shipping information on page 6 of this data sheet.

2SA2125, 2SC5964

ELECTRICAL CHARACTERISTICS ($T_A = 25^\circ\text{C}$)

Symbol	Parameter	Conditions	Ratings			Unit
			Min	Typ	Max	
I_{CBO}	Collector Cutoff Current	$V_{CB} = (-)40\text{ V}, I_E = 0\text{ A}$	-	-	(-) 1	μA
I_{EBO}	Emitter Cutoff Current	$V_{EB} = (-)4\text{ V}, I_C = 0\text{ A}$	-	-	(-) 1	μA
h_{FE1}	DC Current Gain	$V_{CE} = (-)2\text{ V}, I_C = (-)100\text{ mA}$	200	-	560	
f_T	Gain-Bandwidth Product	$V_{CE} = (-)10\text{ V}, I_C = (-)500\text{ mA}$	-	(390)380	-	MHz
C_{ob}	Output Capacitance	$V_{CB} = (-)10\text{ V}, f = 1\text{ MHz}$	-	(24)13	-	pF
$V_{CE(sat)1}$	Collector to Emitter Saturation Voltage	$I_C = (-)1\text{ A}, I_B = (-)50\text{ mA}$	-	(-125)100	(-230)150	mV
$V_{CE(sat)2}$		$I_C = (-)2\text{ A}, I_B = (-)100\text{ mA}$	-	(-250)190	(-500)290	mV
$V_{BE(sat)}$	Base to Emitter Saturation Voltage	$I_C = (-)2\text{ A}, I_B = (-)100\text{ mA}$	-	(-) 0.94	(-) 1.2	V
$V_{(BR)CBO}$	Collector to Base Breakdown Voltage	$I_C = (-)10\text{ }\mu\text{A}, I_E = 0\text{ A}$	(-) 50	100	-	V
$V_{(BR)CES}$	Collector to Emitter Breakdown Voltage	$I_C = (-)100\text{ }\mu\text{A}, R_{BE} = 0\text{ }\Omega$	(-) 50	100	-	V
$V_{(BR)CEO}$		$I_C = (-)1\text{ mA}, R_{BE} = \infty$	(-) 50	-	-	V
$V_{(BR)EBO}$	Emitter to Base Breakdown Voltage	$I_E = (-)10\text{ }\mu\text{A}, I_C = 0\text{ A}$	(-) 6	-	-	V
t_{on}	Turn-ON Time	See specified Test Circuit	-	(30)35	-	ns
t_{stg}	Storage Time		-	(230)300	-	ns
t_f	Fall Time		-	(18)25	-	ns

Product parametric performance is indicated in the Electrical Characteristics for the listed test conditions, unless otherwise noted. Product performance may not be indicated by the Electrical Characteristics if operated under different conditions.

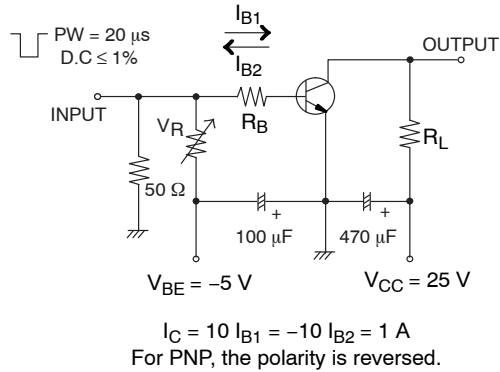
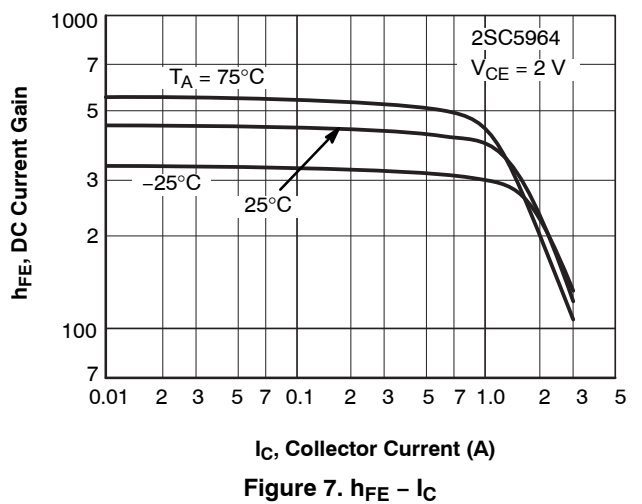
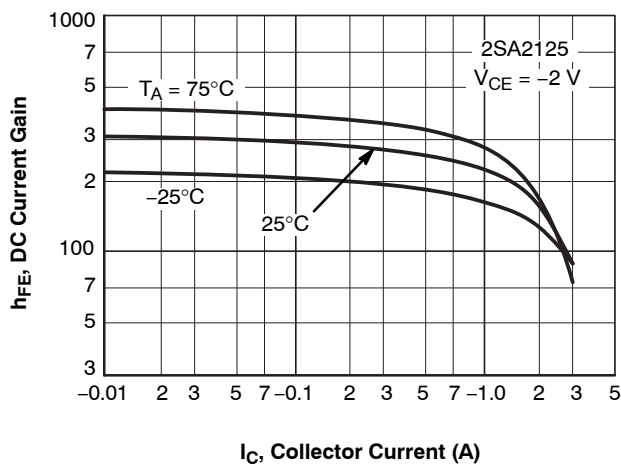
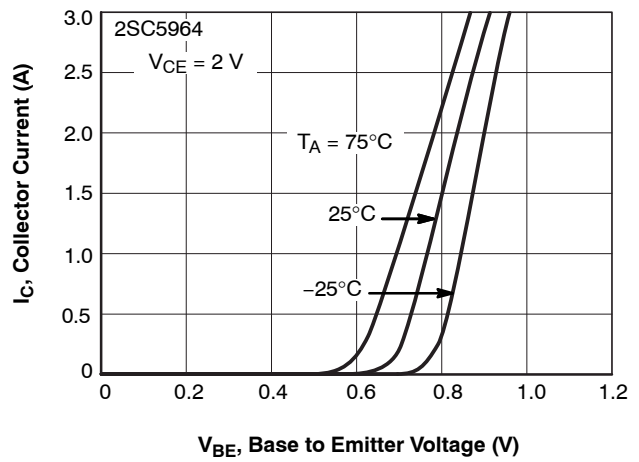
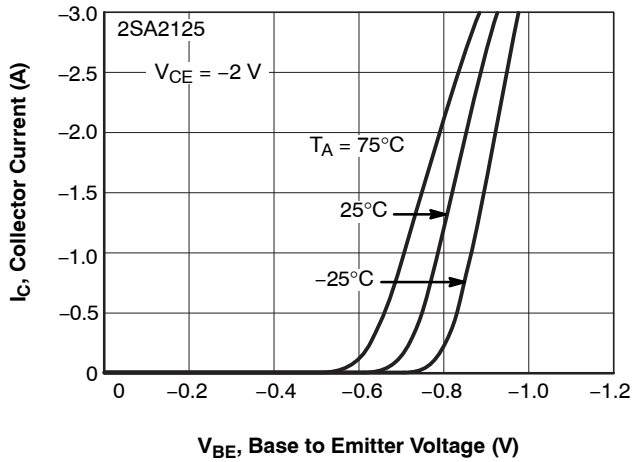
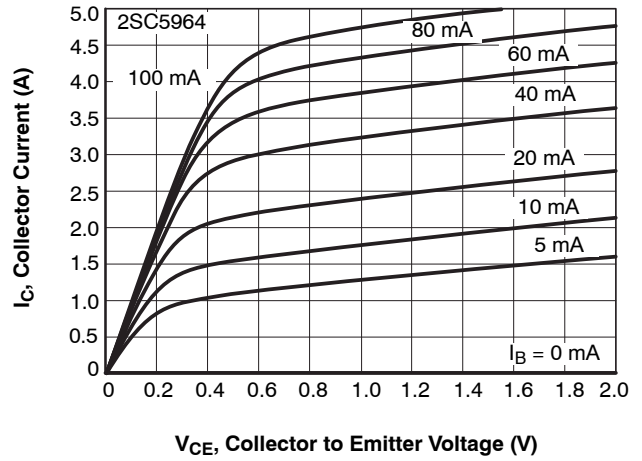
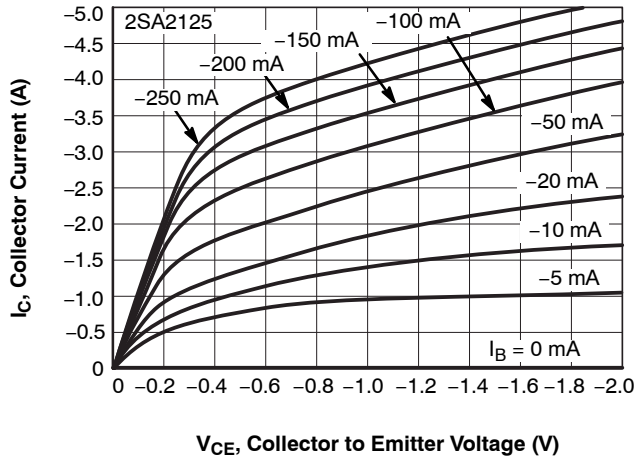

Figure 1. Switching Time Test Circuit

2SA2125, 2SC5964

TYPICAL CHARACTERISTICS



2SA2125, 2SC5964

TYPICAL CHARACTERISTICS (continued)

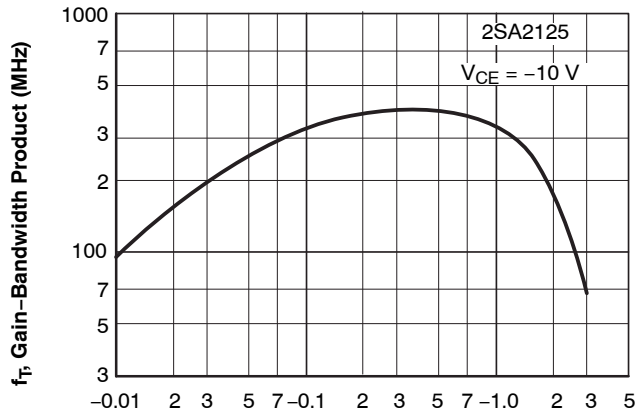

I_C , Collector Current (A)
Figure 8. $f_T - I_C$

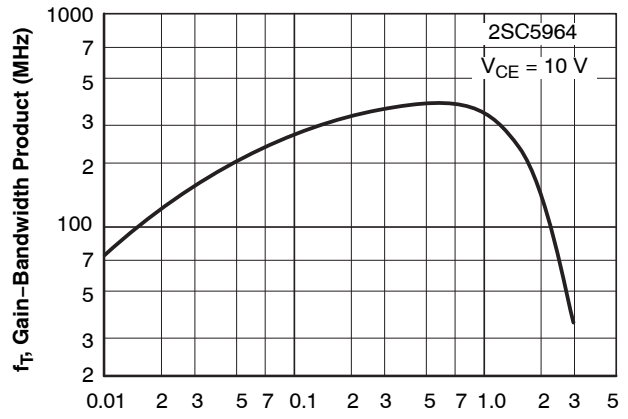

I_C , Collector Current (A)
Figure 9. $f_T - I_C$

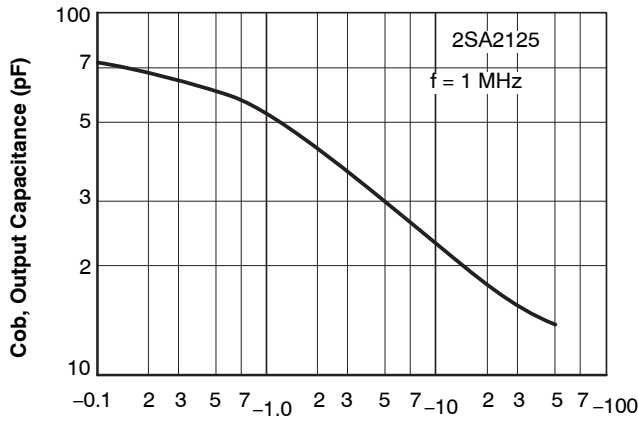

V_{CB} , Collector to Base Voltage (V)
Figure 10. $C_{ob} - V_{CB}$

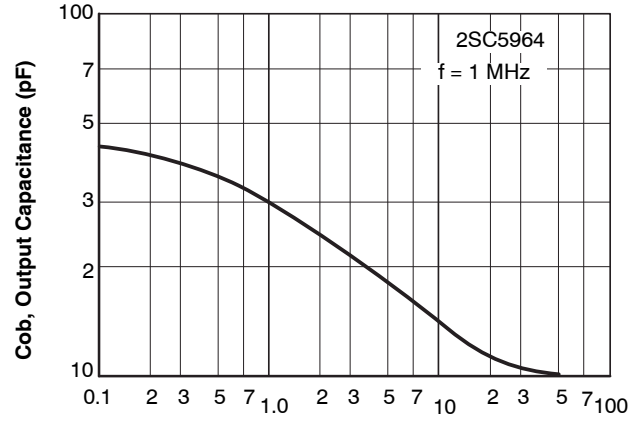

V_{CB} , Collector to Base Voltage (V)
Figure 11. $C_{ob} - V_{CB}$

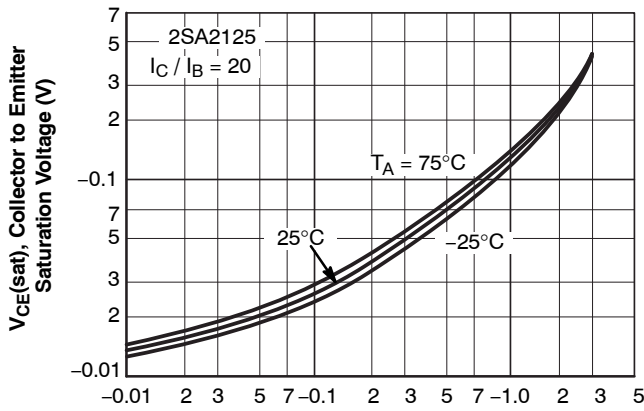

I_C , Collector Current (A)
Figure 12. $V_{CE(sat)} - I_C$

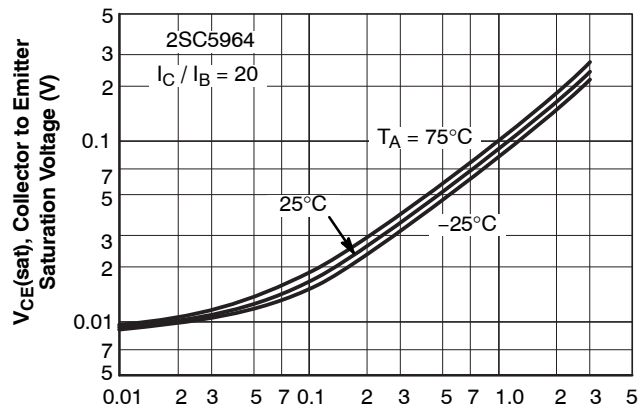

I_C , Collector Current (A)
Figure 13. $V_{CE(sat)} - I_C$

2SA2125, 2SC5964

TYPICAL CHARACTERISTICS (continued)

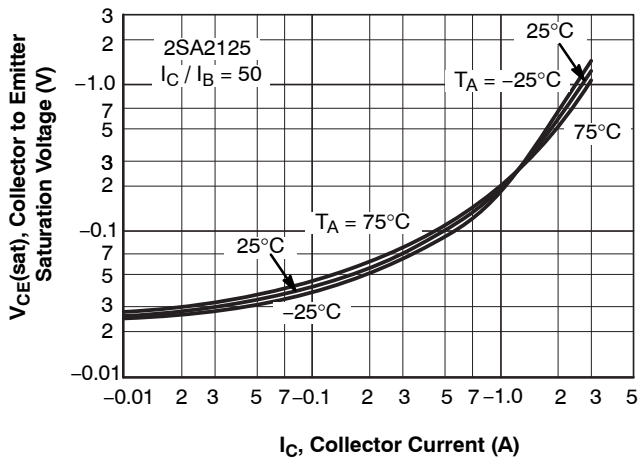

Figure 14. $V_{CE(sat)} - I_C$

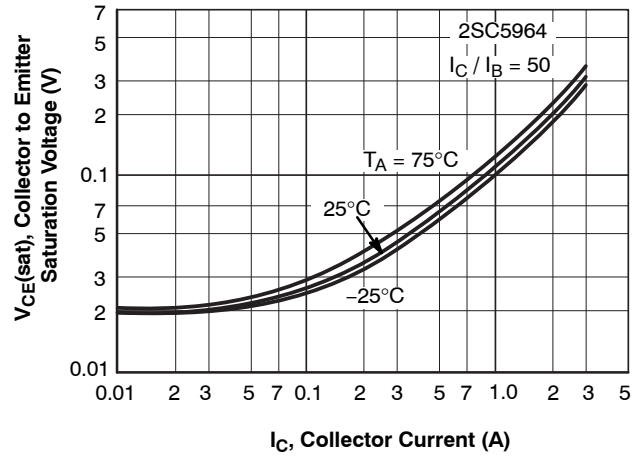

Figure 15. $V_{CE(sat)} - I_C$

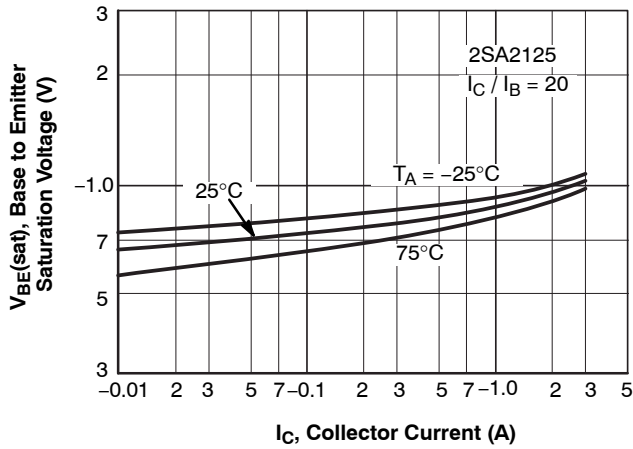

Figure 16. $V_{BE(sat)} - I_C$

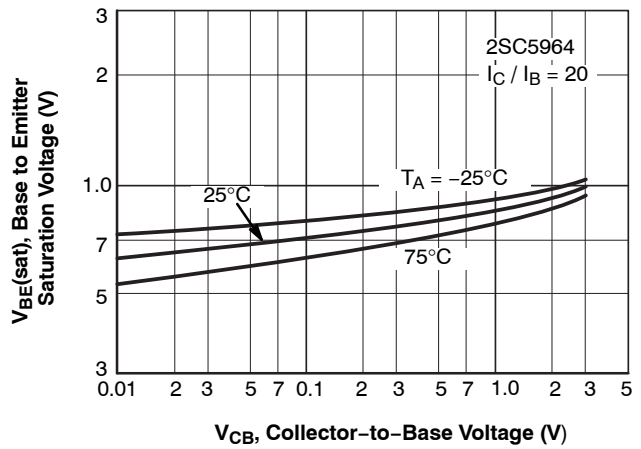

Figure 17. $V_{BE(sat)} - I_C$

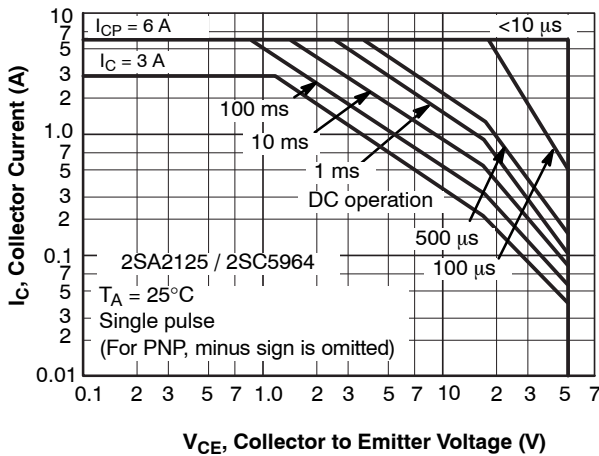

Figure 18. SOA

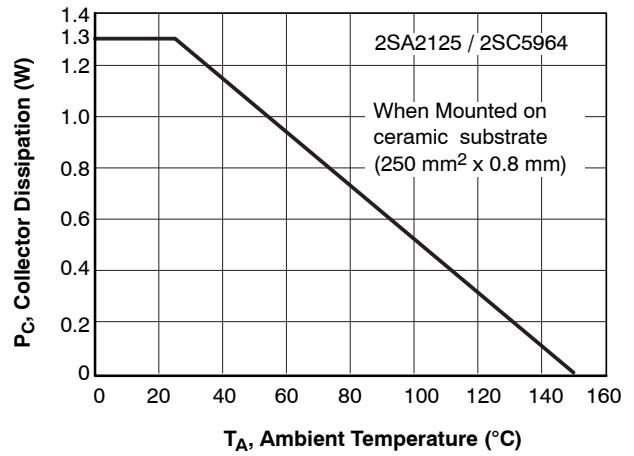

Figure 19. $P_C - T_A$

2SA2125, 2SC5964

TYPICAL CHARACTERISTICS (continued)

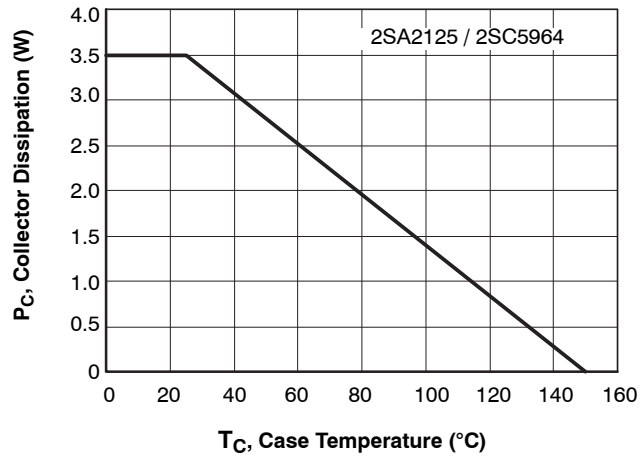

Figure 20. $P_C - T_C$

ORDERING INFORMATION

Device	Package	Shipping [†]
2SA2125-TD-E	SOT-89 / PCP-1 (Pb-Free)	1000 / Tape & Reel
2SA2125-TD-H	SOT-89 / PCP-1 (Pb-Free & Halogen Free)	1000 / Tape & Reel
2SC5964-TD-E	SOT-89 / PCP-1 (Pb-Free)	1000 / Tape & Reel
2SC5964-TD-H	SOT-89 / PCP-1 (Pb-Free & Halogen Free)	1000 / Tape & Reel

[†]For information on tape and reel specifications, including part orientation and tape sizes, please refer to our Tape and Reel Packaging Specifications Brochure, [BRD8011/D](#).

MECHANICAL CASE OUTLINE
PACKAGE DIMENSIONS

ON Semiconductor®



SOT-89 / PCP-1
CASE 419AU
ISSUE O

DATE 30 APR 2012

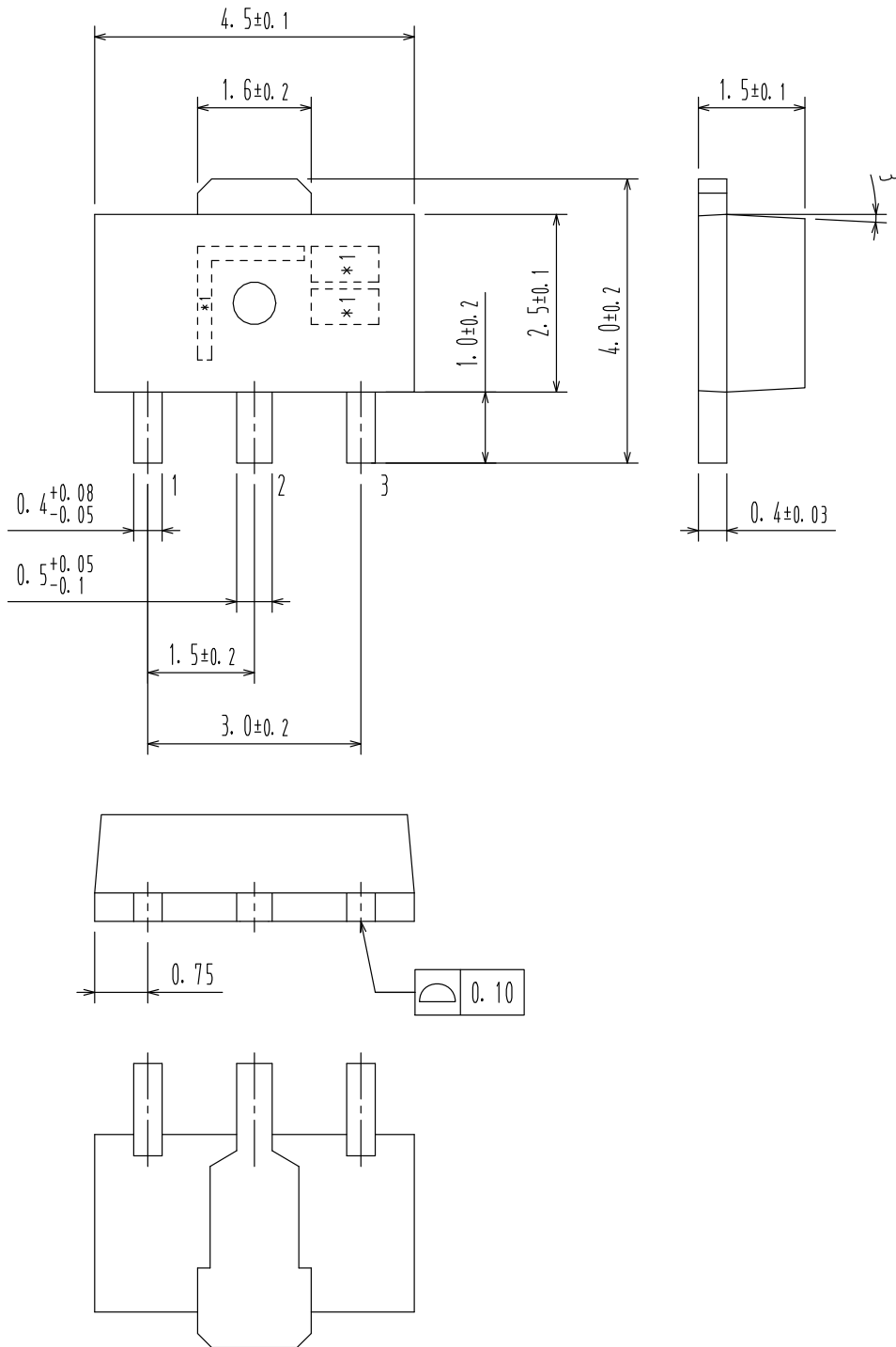

DOCUMENT NUMBER:	98AON79746E	Electronic versions are uncontrolled except when accessed directly from the Document Repository. Printed versions are uncontrolled except when stamped "CONTROLLED COPY" in red.
DESCRIPTION:	SOT-89 / PCP-1	PAGE 1 OF 1

ON Semiconductor and are trademarks of Semiconductor Components Industries, LLC dba ON Semiconductor or its subsidiaries in the United States and/or other countries. ON Semiconductor reserves the right to make changes without further notice to any products herein. ON Semiconductor makes no warranty, representation or guarantee regarding the suitability of its products for any particular purpose, nor does ON Semiconductor assume any liability arising out of the application or use of any product or circuit, and specifically disclaims any and all liability, including without limitation special, consequential or incidental damages. ON Semiconductor does not convey any license under its patent rights nor the rights of others.

onsemi, **Onsemi**, and other names, marks, and brands are registered and/or common law trademarks of Semiconductor Components Industries, LLC dba "**onsemi**" or its affiliates and/or subsidiaries in the United States and/or other countries. **onsemi** owns the rights to a number of patents, trademarks, copyrights, trade secrets, and other intellectual property. A listing of **onsemi**'s product/patent coverage may be accessed at www.onsemi.com/site/pdf/Patent-Marking.pdf. **onsemi** reserves the right to make changes at any time to any products or information herein, without notice. The information herein is provided "as-is" and **onsemi** makes no warranty, representation or guarantee regarding the accuracy of the information, product features, availability, functionality, or suitability of its products for any particular purpose, nor does **onsemi** assume any liability arising out of the application or use of any product or circuit, and specifically disclaims any and all liability, including without limitation special, consequential or incidental damages. Buyer is responsible for its products and applications using **onsemi** products, including compliance with all laws, regulations and safety requirements or standards, regardless of any support or applications information provided by **onsemi**. "Typical" parameters which may be provided in **onsemi** data sheets and/or specifications can and do vary in different applications and actual performance may vary over time. All operating parameters, including "Typicals" must be validated for each customer application by customer's technical experts. **onsemi** does not convey any license under any of its intellectual property rights nor the rights of others. **onsemi** products are not designed, intended, or authorized for use as a critical component in life support systems or any FDA Class 3 medical devices or medical devices with a same or similar classification in a foreign jurisdiction or any devices intended for implantation in the human body. Should Buyer purchase or use **onsemi** products for any such unintended or unauthorized application, Buyer shall indemnify and hold **onsemi** and its officers, employees, subsidiaries, affiliates, and distributors harmless against all claims, costs, damages, and expenses, and reasonable attorney fees arising out of, directly or indirectly, any claim of personal injury or death associated with such unintended or unauthorized use, even if such claim alleges that **onsemi** was negligent regarding the design or manufacture of the part. **onsemi** is an Equal Opportunity/Affirmative Action Employer. This literature is subject to all applicable copyright laws and is not for resale in any manner.

ADDITIONAL INFORMATION

TECHNICAL PUBLICATIONS:

Technical Library: www.onsemi.com/design/resources/technical-documentation
onsemi Website: www.onsemi.com

ONLINE SUPPORT: www.onsemi.com/support

For additional information, please contact your local Sales Representative at www.onsemi.com/support/sales