

# Bipolar Transistor

-50 V, -20 A, Low  $V_{CE(sat)}$ ,  
NPN TO-220F-3SG

## 2SA2210

### 特長

- MBIT プロセス採用
- コレクタ・エミッタ飽和電圧が低い
- 電流容量が大きい
- スイッチングスピードが速い
- This is a Pb-Free Device

### 用途

- リレードライブ, ランプドライブ, モータドライブ。

### 絶対最大定格 ABSOLUTE MAXIMUM RATINGS ( $T_a = 25^\circ\text{C}$ )

項目	記号	条件	定格値	Unit
コレクタ・ベース電圧	$V_{CB0}$		-50	V
コレクタ・エミッタ電圧	$V_{CEO}$		-50	V
エミッタ・ベース電圧	$V_{EBO}$		-6	V
コレクタ電流	$I_C$		-20	A
コレクタ電流(パルス)	$I_{CP}$		-25	A
ベース電流	$I_B$		-3	A
コレクタ損失	$P_C$		2	W
		$T_C = 25^\circ\text{C}$	30	W
接合部温度	$T_j$		150	$^\circ\text{C}$
保存周囲温度	$T_{stg}$		-55 to +150	$^\circ\text{C}$

Stresses exceeding those listed in the Maximum Ratings table may damage the device. If any of these limits are exceeded, device functionality should not be assumed, damage may occur and reliability may be affected.

(参考訳)

最大定格を超えるストレスは、デバイスにダメージを与える危険性があります。これらの定格値を超えた場合は、デバイスの機能性を損ない、ダメージが生じたり、信頼性に影響を及ぼす危険性があります。

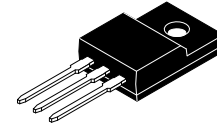

TO-220 Fullpack, 3-Lead /  
TO-220F-3SG  
CASE 221AT

### 電氣的接続図

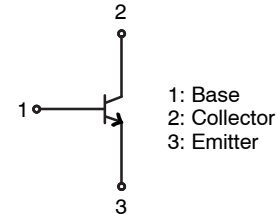

### 製品と外形に伴う情報

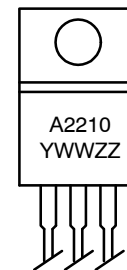

A2210 = Device Code  
YWW = Date Code (Year & Week)  
ZZ = Assembly Lot

### ORDERING INFORMATION

Device	Package	Shipping
2SA2210-1E	TO-220F (Pb-Free)	50 / Tube

## 2SA2210

### 電気的特性 ELECTRICAL CHARACTERISTICS (Ta = 25°C)

項目	記号	条件	Min	Typ	Max	Unit
コレクタシャ断電流	$I_{CBO}$	$V_{CB} = -40\text{ V}, I_E = 0\text{ A}$	-	-	-10	$\mu\text{A}$
エミッタシャ断電流	$I_{EBO}$	$V_{EB} = -4\text{ V}, I_C = 0\text{ A}$	-	-	-10	$\mu\text{A}$
直流電流増幅率	$h_{FE}$	$V_{CE} = -2\text{ V}, I_C = -1\text{ A}$	150	-	450	
利得帯域幅積	$f_T$	$V_{CE} = -10\text{ V}, I_C = -1\text{ A}$	-	140	-	MHz
出力容量	$C_{ob}$	$V_{CB} = -10\text{ V}, f = 1\text{ MHz}$	-	215	-	pF
コレクタ・エミッタ飽和電圧	$V_{CE(sat)}$	$I_C = -7\text{ A}, I_B = -350\text{ mA}$	-	-200	-500	mV
ベース・エミッタ飽和電圧	$V_{BE(sat)}$	$I_C = -7\text{ A}, I_B = -350\text{ mA}$	-	-	-1.2	V
コレクタ・ベース降伏電圧	$V_{(BR)CBO}$	$I_C = -100\text{ }\mu\text{A}, I_E = 0\text{ A}$	-50	-	-	V
コレクタ・エミッタ降伏電圧	$V_{(BR)CEO}$	$I_C = -1\text{ mA}, R_{BE} = \infty$	-50	-	-	V
エミッタ・ベース降伏電圧	$V_{(BR)EBO}$	$I_E = -100\text{ }\mu\text{A}, I_C = 0\text{ A}$	-6	-	-	V
ターンオン時間	$t_{on}$	指定回路において		60	-	ns
蓄積時間	$t_{stg}$			270	-	ns
下降時間	$t_f$			20	-	ns

Product parametric performance is indicated in the Electrical Characteristics for the listed test conditions, unless otherwise noted. Product performance may not be indicated by the Electrical Characteristics if operated under different conditions.

(参考訳)

製品パラメータは、特別な記述が無い限り、記載されたテスト条件に対する電気的特性で示しています。異なる条件下で製品動作を行った時には、電気的特性で示している特性を得られない場合があります。

### スイッチングタイム測定回路図

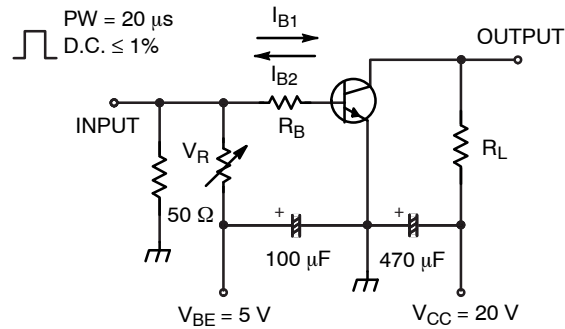

$$I_C = 20I_{B1} = -20I_{B2} = -7\text{ A}$$

図 1. スwitchingタイム測定回路図

TYPICAL CHARACTERISTICS



図 2.  $I_C - V_{CE}$



図 3.  $I_C - V_{CE}$

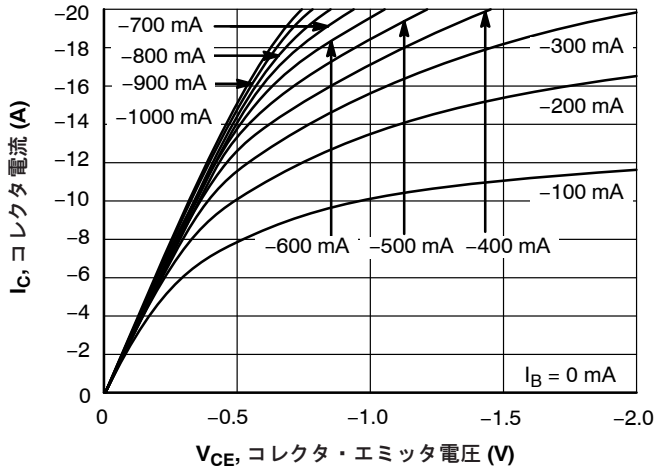

図 4.  $I_C - V_{BE}$

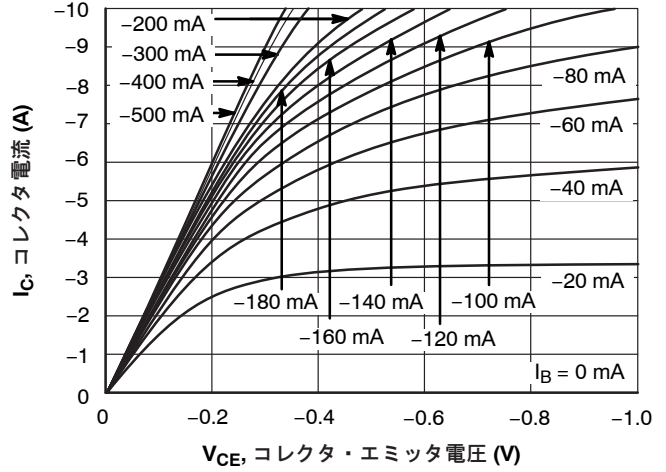

図 5.  $h_{FE} - I_C$

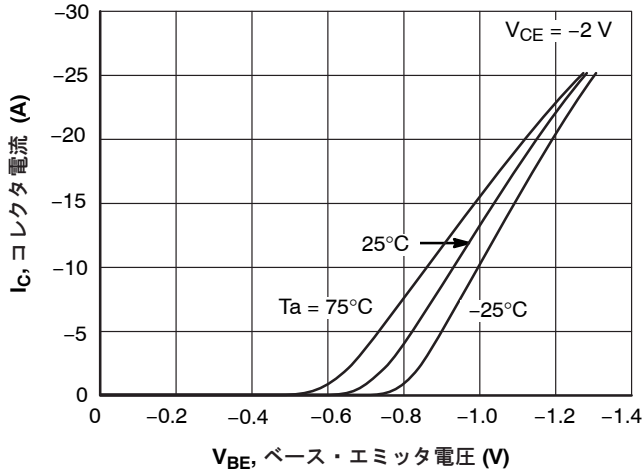

図 6.  $h_{FE} - I_C$

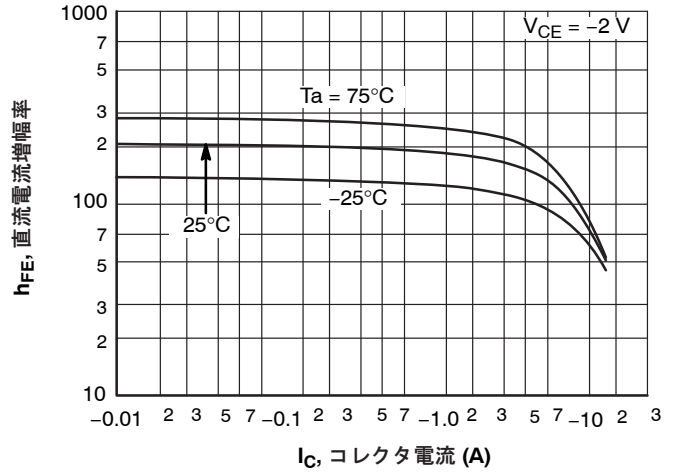

図 7.  $f_T - I_C$

TYPICAL CHARACTERISTICS (continued)

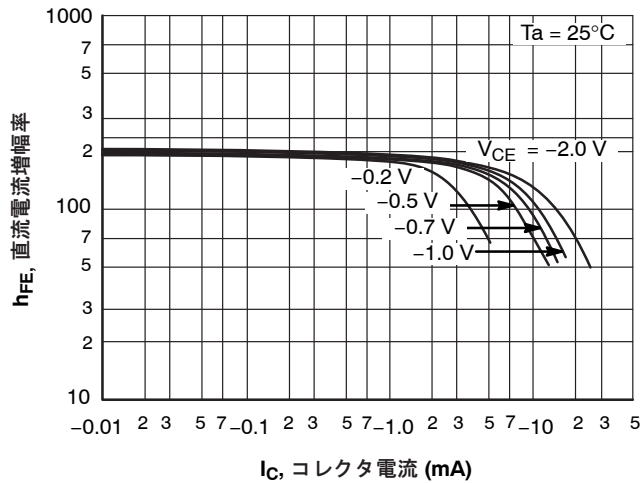

図 8.  $C_{ob} - V_{CB}$

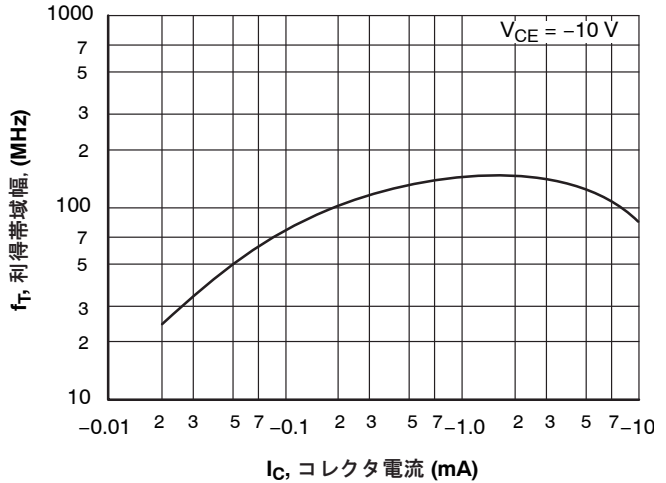

図 9.  $V_{CE(sat)} - I_C$

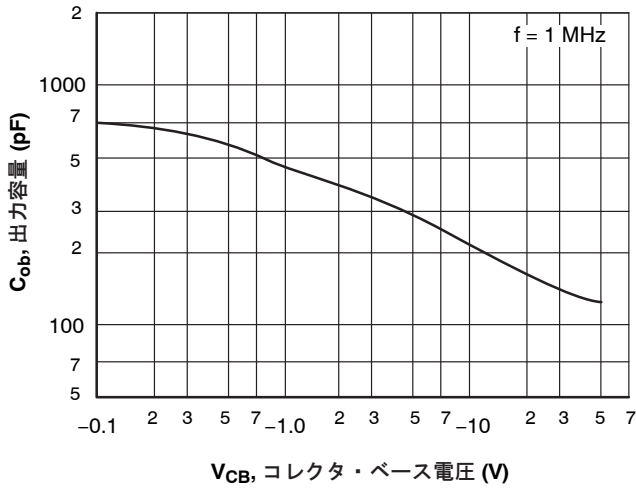

図 10.  $V_{CE(sat)} - I_C$

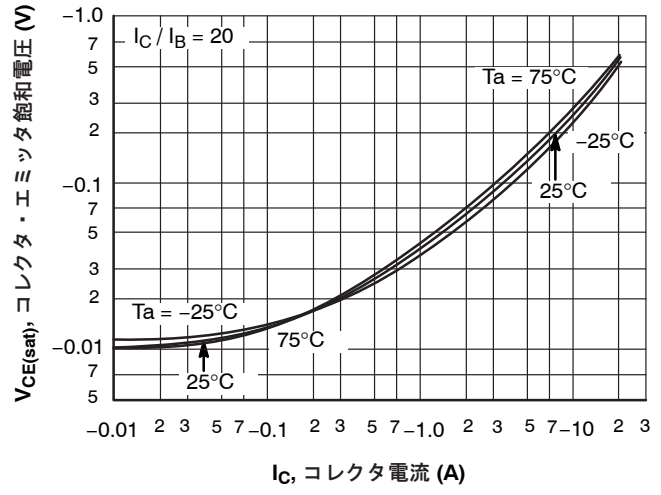

図 11.  $V_{BE(sat)} - I_C$

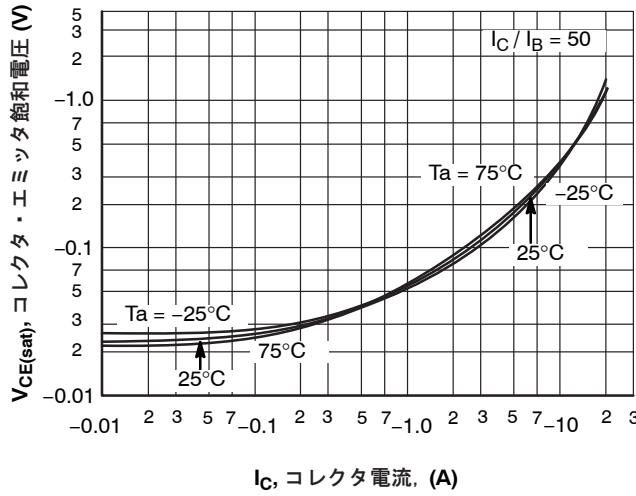

図 12. Forward Bias ASO

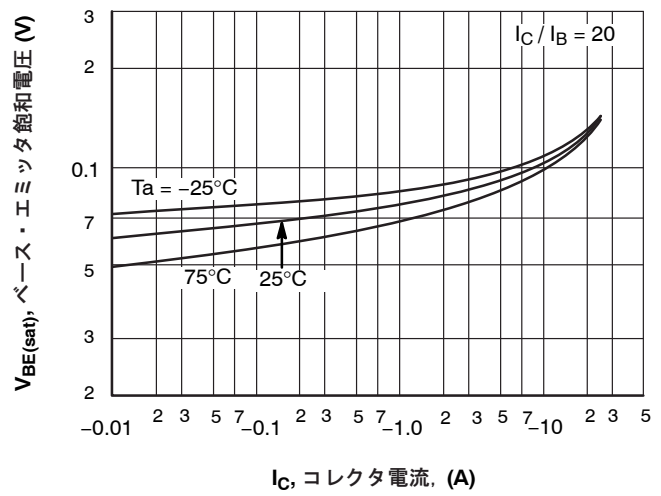

図 13.  $P_C - T_a$

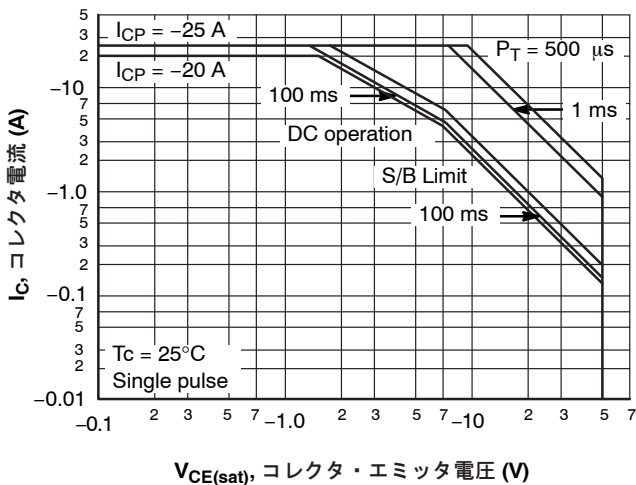

$T_C$ , ケース温度 (°C)

図 14.  $P_C - T_C$

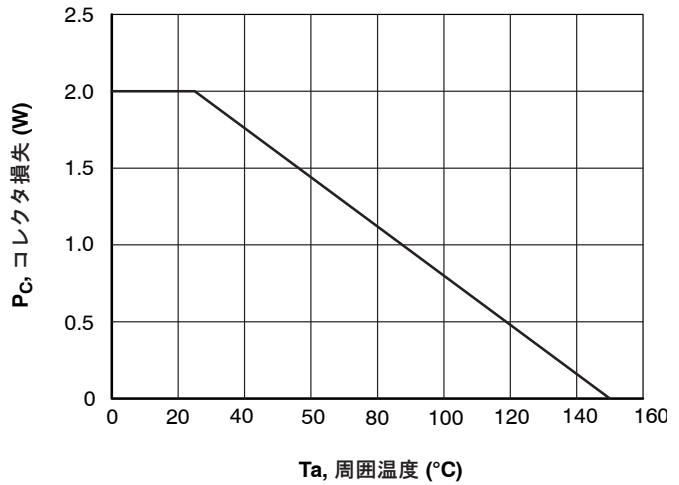
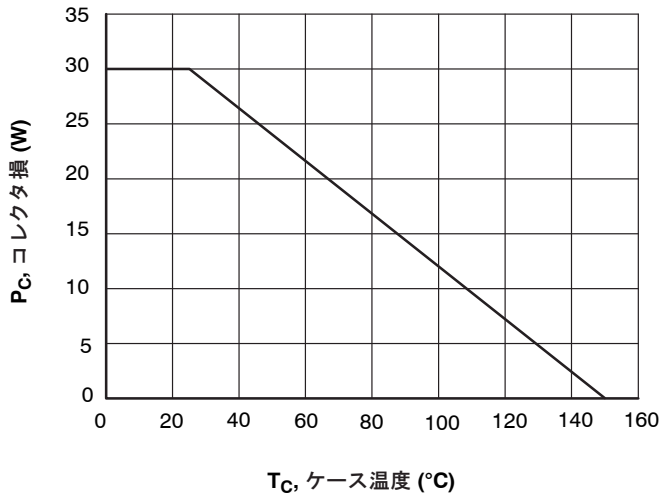
# MECHANICAL CASE OUTLINE

## PACKAGE DIMENSIONS

ON Semiconductor®



### TO-220 Fullpack, 3-Lead / TO-220F-3SG CASE 221AT ISSUE B

DATE 19 JAN 2021

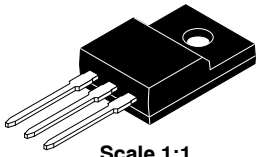

Scale 1:1

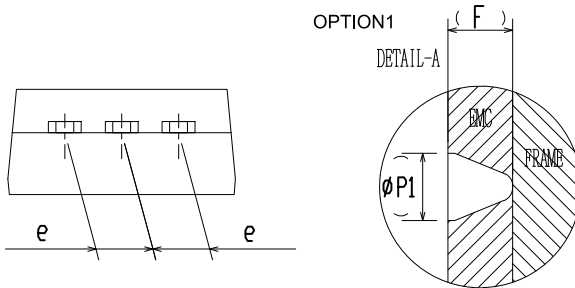
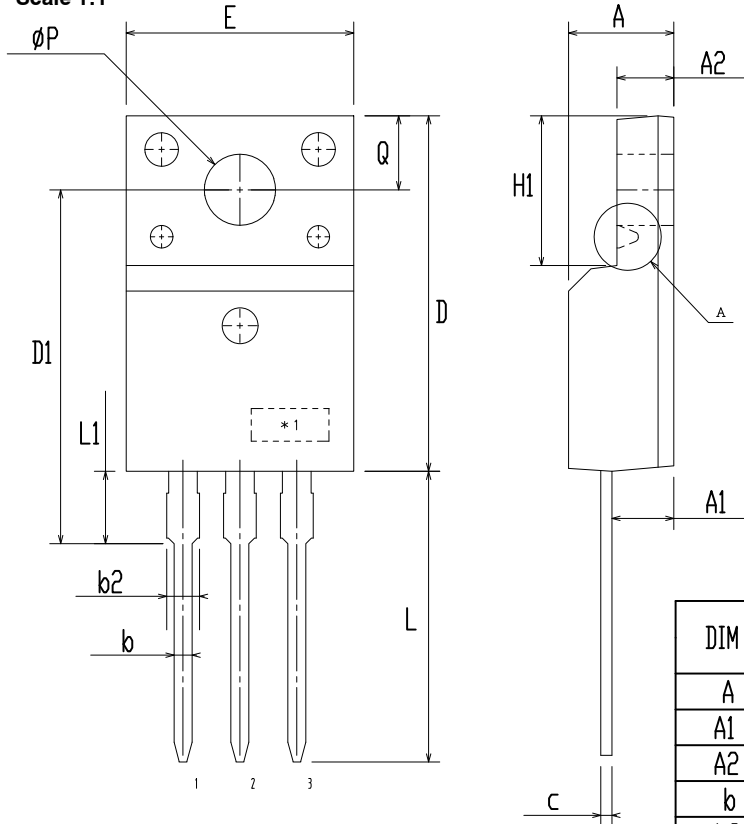

DIM	MILLIMETERS		
	MIN	NOM	MAX
A	4.50	4.70	4.90
A1	2.56	2.76	2.96
A2	2.34	2.54	2.74
b	0.70	0.80	0.90
b2	~	~	1.47
c	0.45	0.50	0.60
D	15.67	15.87	16.07
D1	15.60	15.80	16.00
E	9.96	10.16	10.36
e	2.34	2.54	2.74
F	~	0.84	~
H1	6.48	6.68	6.88
L	12.78	12.98	13.18
L1	3.03	3.23	3.43
phi P	2.98	3.18	3.38
phi P1	~	1.00	~
Q	3.20	3.30	3.40

**NOTES:**

- A. DIMENSION AND TOLERANCE AS ASME Y14.5-2009
- B. DIMENSIONS ARE EXCLUSIVE OF BURRS, MOLD FLASH AND TIE BAR PROTRUCTIONS.
- C. OPTION 1 - WITH SUPPORT PIN HOLE  
OPTION 2 - NO SUPPORT PIN HOLE

<b>DOCUMENT NUMBER:</b>	<b>98AON67439E</b>	Electronic versions are uncontrolled except when accessed directly from the Document Repository. Printed versions are uncontrolled except when stamped "CONTROLLED COPY" in red.
<b>DESCRIPTION:</b>	<b>TO-220 FULLPACK, 3-LEAD / TO-220F-3SG</b>	<b>PAGE 1 OF 1</b>

ON Semiconductor and are trademarks of Semiconductor Components Industries, LLC dba ON Semiconductor or its subsidiaries in the United States and/or other countries. ON Semiconductor reserves the right to make changes without further notice to any products herein. ON Semiconductor makes no warranty, representation or guarantee regarding the suitability of its products for any particular purpose, nor does ON Semiconductor assume any liability arising out of the application or use of any product or circuit, and specifically disclaims any and all liability, including without limitation special, consequential or incidental damages. ON Semiconductor does not convey any license under its patent rights nor the rights of others.

**onsemi**, **Onsemi**, and other names, marks, and brands are registered and/or common law trademarks of Semiconductor Components Industries, LLC dba "**onsemi**" or its affiliates and/or subsidiaries in the United States and/or other countries. **onsemi** owns the rights to a number of patents, trademarks, copyrights, trade secrets, and other intellectual property. A listing of **onsemi**'s product/patent coverage may be accessed at [www.onsemi.com/site/pdf/Patent-Marking.pdf](http://www.onsemi.com/site/pdf/Patent-Marking.pdf). **onsemi** reserves the right to make changes at any time to any products or information herein, without notice. The information herein is provided "as-is" and **onsemi** makes no warranty, representation or guarantee regarding the accuracy of the information, product features, availability, functionality, or suitability of its products for any particular purpose, nor does **onsemi** assume any liability arising out of the application or use of any product or circuit, and specifically disclaims any and all liability, including without limitation special, consequential or incidental damages. Buyer is responsible for its products and applications using **onsemi** products, including compliance with all laws, regulations and safety requirements or standards, regardless of any support or applications information provided by **onsemi**. "Typical" parameters which may be provided in **onsemi** data sheets and/or specifications can and do vary in different applications and actual performance may vary over time. All operating parameters, including "Typicals" must be validated for each customer application by customer's technical experts. **onsemi** does not convey any license under any of its intellectual property rights nor the rights of others. **onsemi** products are not designed, intended, or authorized for use as a critical component in life support systems or any FDA Class 3 medical devices or medical devices with a same or similar classification in a foreign jurisdiction or any devices intended for implantation in the human body. Should Buyer purchase or use **onsemi** products for any such unintended or unauthorized application, Buyer shall indemnify and hold **onsemi** and its officers, employees, subsidiaries, affiliates, and distributors harmless against all claims, costs, damages, and expenses, and reasonable attorney fees arising out of, directly or indirectly, any claim of personal injury or death associated with such unintended or unauthorized use, even if such claim alleges that **onsemi** was negligent regarding the design or manufacture of the part. **onsemi** is an Equal Opportunity/Affirmative Action Employer. This literature is subject to all applicable copyright laws and is not for resale in any manner.

## ADDITIONAL INFORMATION

### TECHNICAL PUBLICATIONS:

Technical Library: [www.onsemi.com/design/resources/technical-documentation](http://www.onsemi.com/design/resources/technical-documentation)  
onsemi Website: [www.onsemi.com](http://www.onsemi.com)

### ONLINE SUPPORT: [www.onsemi.com/support](http://www.onsemi.com/support)

For additional information, please contact your local Sales Representative at [www.onsemi.com/support/sales](http://www.onsemi.com/support/sales)