



Is Now Part of



ON Semiconductor®

To learn more about ON Semiconductor, please visit our website at
www.onsemi.com

Please note: As part of the Fairchild Semiconductor integration, some of the Fairchild orderable part numbers will need to change in order to meet ON Semiconductor's system requirements. Since the ON Semiconductor product management systems do not have the ability to manage part nomenclature that utilizes an underscore (_), the underscore (_) in the Fairchild part numbers will be changed to a dash (-). This document may contain device numbers with an underscore (_). Please check the ON Semiconductor website to verify the updated device numbers. The most current and up-to-date ordering information can be found at www.onsemi.com. Please email any questions regarding the system integration to Fairchild_questions@onsemi.com.

ON Semiconductor and the ON Semiconductor logo are trademarks of Semiconductor Components Industries, LLC dba ON Semiconductor or its subsidiaries in the United States and/or other countries. ON Semiconductor owns the rights to a number of patents, trademarks, copyrights, trade secrets, and other intellectual property. A listing of ON Semiconductor's product/patent coverage may be accessed at www.onsemi.com/site/pdf/Patent-Marking.pdf. ON Semiconductor reserves the right to make changes without further notice to any products herein. ON Semiconductor makes no warranty, representation or guarantee regarding the suitability of its products for any particular purpose, nor does ON Semiconductor assume any liability arising out of the application or use of any product or circuit, and specifically disclaims any and all liability, including without limitation special, consequential or incidental damages. Buyer is responsible for its products and applications using ON Semiconductor products, including compliance with all laws, regulations and safety requirements or standards, regardless of any support or applications information provided by ON Semiconductor. "Typical" parameters which may be provided in ON Semiconductor data sheets and/or specifications can and do vary in different applications and actual performance may vary over time. All operating parameters, including "Typicals" must be validated for each customer application by customer's technical experts. ON Semiconductor does not convey any license under its patent rights nor the rights of others. ON Semiconductor products are not designed, intended, or authorized for use as a critical component in life support systems or any FDA Class 3 medical devices or medical devices with a same or similar classification in a foreign jurisdiction or any devices intended for implantation in the human body. Should Buyer purchase or use ON Semiconductor products for any such unintended or unauthorized application, Buyer shall indemnify and hold ON Semiconductor and its officers, employees, subsidiaries, affiliates, and distributors harmless against all claims, costs, damages, and expenses, and reasonable attorney fees arising out of, directly or indirectly, any claim of personal injury or death associated with such unintended or unauthorized use, even if such claim alleges that ON Semiconductor was negligent regarding the design or manufacture of the part. ON Semiconductor is an Equal Opportunity/Affirmative Action Employer. This literature is subject to all applicable copyright laws and is not for resale in any manner.

FCP104N60F

N-Channel SuperFET® II FRFET® MOSFET

600 V, 37 A, 104 mΩ

Features

- 650 V @ $T_J = 150^\circ\text{C}$
- Typ. $R_{DS(on)} = 91\text{ m}\Omega$
- Ultra Low Gate Charge (Typ. $Q_g = 110\text{ nC}$)
- Low Effective Output Capacitance (Typ. $C_{oss(eff.)} = 313\text{ pF}$)
- 100% Avalanche Tested

Applications

- Lighting
- Solar Inverter
- AC-DC Power Supply

Description

SuperFET® II MOSFET is Fairchild Semiconductor's brand-new high voltage super-junction (SJ) MOSFET family that is utilizing charge balance technology for outstanding low on-resistance and lower gate charge performance. This technology is tailored to minimize conduction loss, provide superior switching performance, dv/dt rate and higher avalanche energy. Consequently, SuperFET II MOSFET is very suitable for the switching power applications such as PFC, server/telecom power, FPD TV power, ATX power and industrial power applications. SuperFET® II FRFET® MOSFET's optimized body diode reverse recovery performance can remove additional component and improve system reliability.

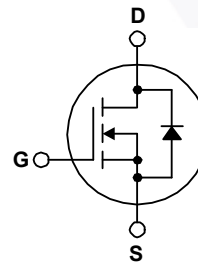
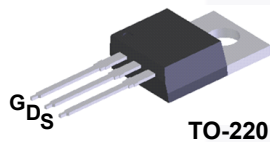

MOSFET Maximum Ratings $T_C = 25^\circ\text{C}$ unless otherwise noted.

Symbol	Parameter	FCP104N60F	Unit
V_{DSS}	Drain to Source Voltage	600	V
V_{GSS}	Gate to Source Voltage	- DC	± 20
		- AC (f > 1Hz)	± 30
I_D	Drain Current	- Continuous ($T_C = 25^\circ\text{C}$)	37
		- Continuous ($T_C = 100^\circ\text{C}$)	24
I_{DM}	Drain Current	- Pulsed (Note 1)	114
E_{AS}	Single Pulsed Avalanche Energy	(Note 2)	809
I_{AR}	Avalanche Current	(Note 1)	6.8
E_{AR}	Repetitive Avalanche Energy	(Note 1)	3.57
dv/dt	Peak Diode Recovery dv/dt	(Note 3)	50
	MOSFET dv/dt		100
P_D	Power Dissipation	($T_C = 25^\circ\text{C}$)	357
		- Derate Above 25°C	2.85
T_J, T_{STG}	Operating and Storage Temperature Range	-55 to +150	$^\circ\text{C}$
T_L	Maximum Lead Temperature for Soldering, 1/8" from Case for 5 Seconds	300	$^\circ\text{C}$

Thermal Characteristics

Symbol	Parameter	FCP104N60F	Unit
$R_{\theta JC}$	Thermal Resistance, Junction to Case, Max.	0.35	$^\circ\text{C/W}$
$R_{\theta JA}$	Thermal Resistance, Junction to Ambient, Max.	62.5	

Package Marking and Ordering Information

Part Number	Top Mark	Package	Packing Method	Reel Size	Tape Width	Quantity
FCP104N60F	FCP104N60F	TO220	Tube	N/A	N/A	50 units

Electrical Characteristics $T_C = 25^\circ\text{C}$ unless otherwise noted.

Symbol	Parameter	Test Conditions	Min.	Typ.	Max.	Unit
--------	-----------	-----------------	------	------	------	------

Off Characteristics

BV _{DSS}	Drain to Source Breakdown Voltage	$V_{GS} = 0\text{ V}, I_D = 10\text{ mA}, T_J = 25^\circ\text{C}$	600	-	-	V
		$V_{GS} = 0\text{ V}, I_D = 10\text{ mA}, T_J = 150^\circ\text{C}$	650	-	-	
$\Delta BV_{DSS} / \Delta T_J$	Breakdown Voltage Temperature Coefficient	$I_D = 10\text{ mA}$, Referenced to 25°C	-	0.67	-	$V/^\circ\text{C}$
BV _{DS}	Drain-Source Avalanche Breakdown Voltage	$V_{GS} = 0\text{ V}, I_D = 18.5\text{ A}$	-	700	-	V
I _{DSS}	Zero Gate Voltage Drain Current	$V_{DS} = 600\text{ V}, V_{GS} = 0\text{ V}$	-	-	10	μA
		$V_{DS} = 480\text{ V}, T_C = 125^\circ\text{C}$	-	16	-	
I _{GSS}	Gate to Body Leakage Current	$V_{GS} = \pm 20\text{ V}, V_{DS} = 0\text{ V}$	-	-	± 100	nA

On Characteristics

V _{GS(th)}	Gate Threshold Voltage	$V_{GS} = V_{DS}, I_D = 250\ \mu\text{A}$	3	-	5	V
R _{DS(on)}	Static Drain to Source On Resistance	$V_{GS} = 10\text{ V}, I_D = 18.5\text{ A}$	-	91	104	m Ω
g _{FS}	Forward Transconductance	$V_{DS} = 20\text{ V}, I_D = 18.5\text{ A}$	-	33	-	S

Dynamic Characteristics

C _{iss}	Input Capacitance	$V_{DS} = 25\text{ V}, V_{GS} = 0\text{ V}$ $f = 1\text{ MHz}$	-	4610	6130	pF
C _{oss}	Output Capacitance		-	3255	4330	pF
C _{rss}	Reverse Transfer Capacitance		-	155	235	pF
C _{oss}	Output Capacitance	$V_{DS} = 380\text{ V}, V_{GS} = 0\text{ V}, f = 1\text{ MHz}$	-	74	-	pF
C _{oss eff.}	Effective Output Capacitance	$V_{DS} = 0\text{ V to } 480\text{ V}, V_{GS} = 0\text{ V}$	-	313	-	pF
Q _{g(tot)}	Total Gate Charge at 10V	$V_{DS} = 380\text{ V}, I_D = 18.5\text{ A}$ $V_{GS} = 10\text{ V}$ (Note 4)	-	110	145	nC
Q _{gs}	Gate to Source Gate Charge		-	24	-	nC
Q _{gd}	Gate to Drain "Miller" Charge		-	44	-	nC
ESR	Equivalent Series Resistance	Drain open		0.9		Ω

Switching Characteristics

t _{d(on)}	Turn-On Delay Time	$V_{DD} = 380\text{ V}, I_D = 18.5\text{ A}$ $V_{GS} = 10\text{ V}, R_{GEN} = 4.7\ \Omega$ (Note 4)	-	34	78	ns
t _r	Turn-On Rise Time		-	20	50	ns
t _{d(off)}	Turn-Off Delay Time		-	102	214	ns
t _f	Turn-Off Fall Time		-	5.7	21.4	ns

Drain-Source Diode Characteristics

I _S	Maximum Continuous Drain to Source Diode Forward Current	-	-	37	A	
I _{SM}	Maximum Pulsed Drain to Source Diode Forward Current	-	-	114	A	
V _{SD}	Drain to Source Diode Forward Voltage	$V_{GS} = 0\text{ V}, I_{SD} = 18.5\text{ A}$	-	-	1.2	V
t _{rr}	Reverse Recovery Time	$V_{GS} = 0\text{ V}, I_{SD} = 18.5\text{ A}$	-	144	-	ns
Q _{rr}	Reverse Recovery Charge	$di_F/dt = 100\text{ A}/\mu\text{s}$	-	0.91	-	μC

Notes:

1. Repetitive Rating: Pulse width limited by maximum junction temperature
2. $I_{AS} = 6.8\text{ A}, V_{DD} = 50\text{ V}, R_G = 25\ \Omega$, Starting $T_J = 25^\circ\text{C}$
3. $I_{SD} \leq 18.5\text{ A}, di/dt \leq 200\text{ A}/\mu\text{s}, V_{DD} \leq BV_{DSS}$, Starting $T_J = 25^\circ\text{C}$
4. Essentially Independent of Operating Temperature Typical Characteristics

Typical Characteristics

Figure 1. On-Region Characteristics

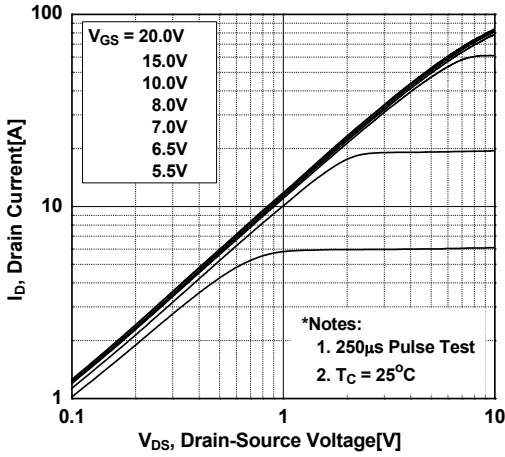

Figure 2. Transfer Characteristics

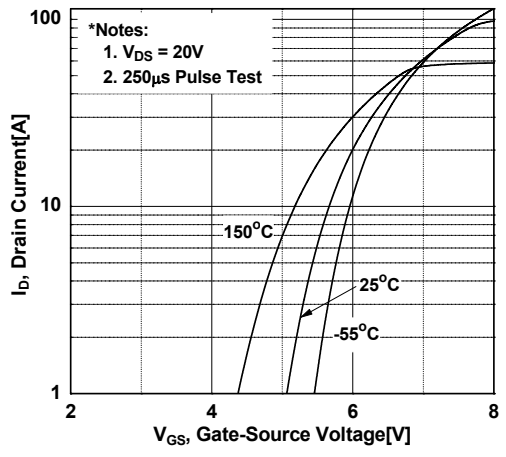

Figure 3. On-Resistance Variation vs. Drain Current and Gate Voltage

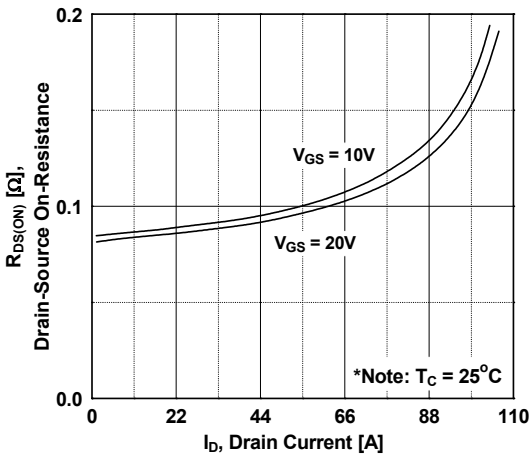

Figure 4. Body Diode Forward Voltage Variation vs. Source Current and Temperature

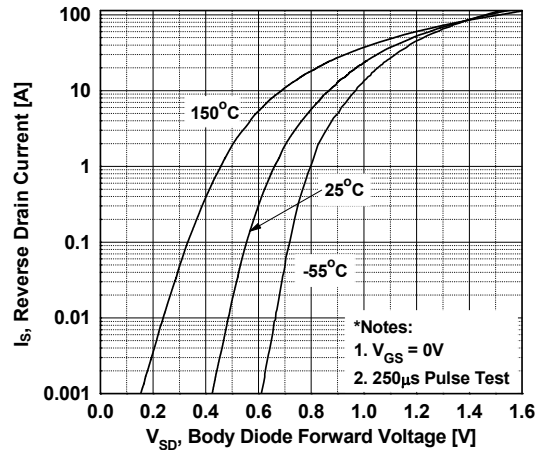

Figure 5. Capacitance Characteristics

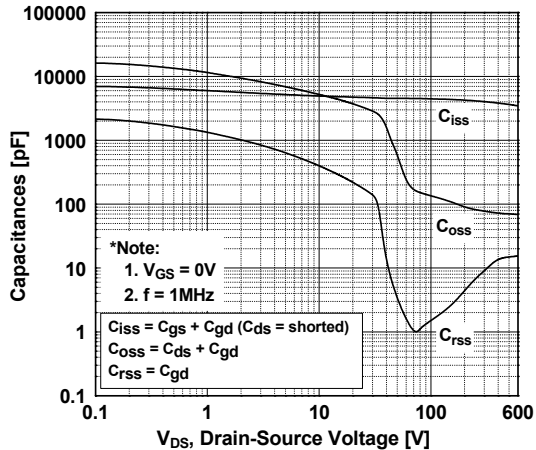
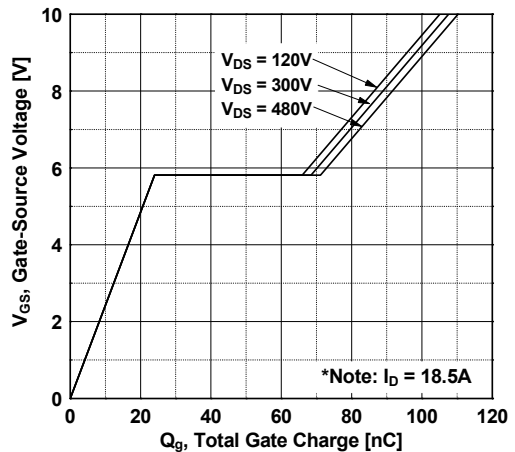

Figure 6. Gate Charge Characteristics



Typical Characteristics (Continued)

Figure 7. Breakdown Voltage Variation vs. Temperature

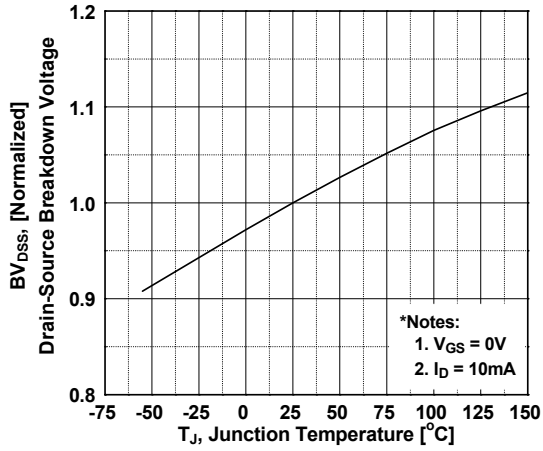

Figure 8. On-Resistance Variation vs. Temperature

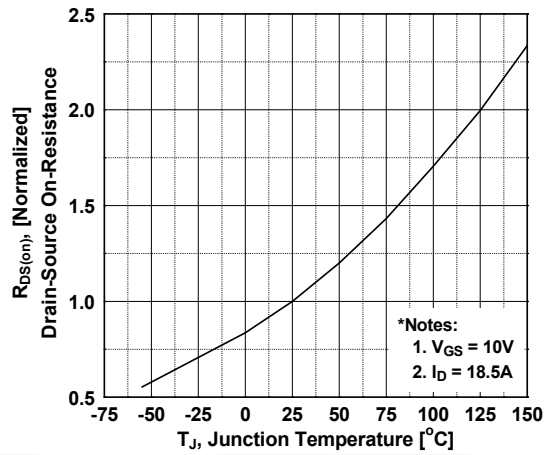

Figure 9. Maximum Safe Operating Area

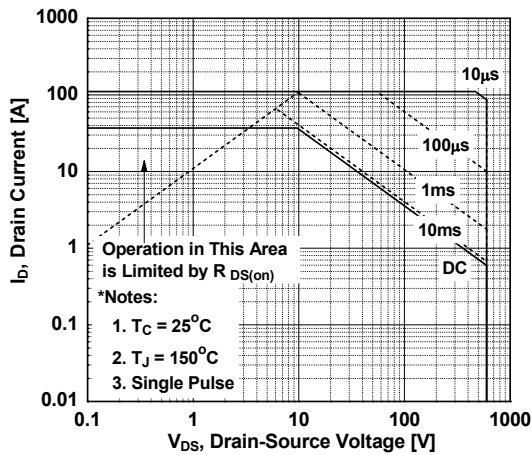

Figure 10. Maximum Drain Current vs. Case Temperature

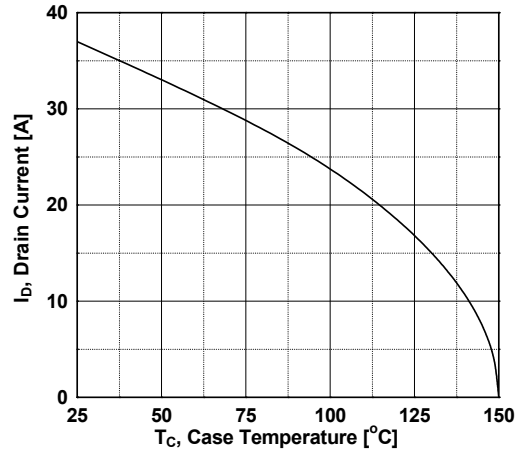

Figure 11. Transient Thermal Response Curve

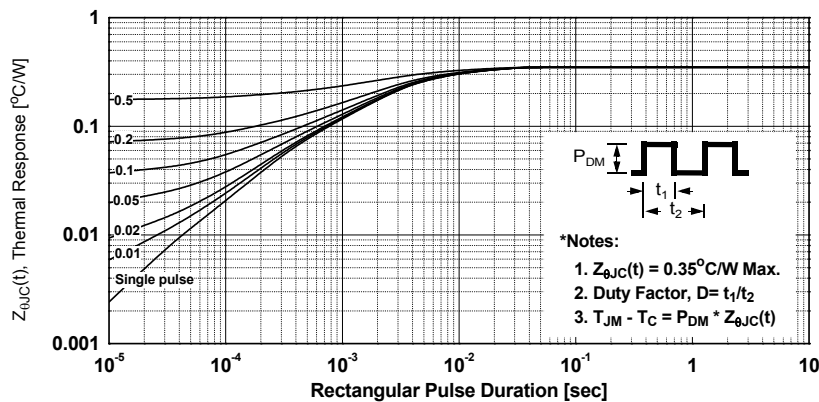

Figure 12. Gate Charge Test Circuit & Waveform

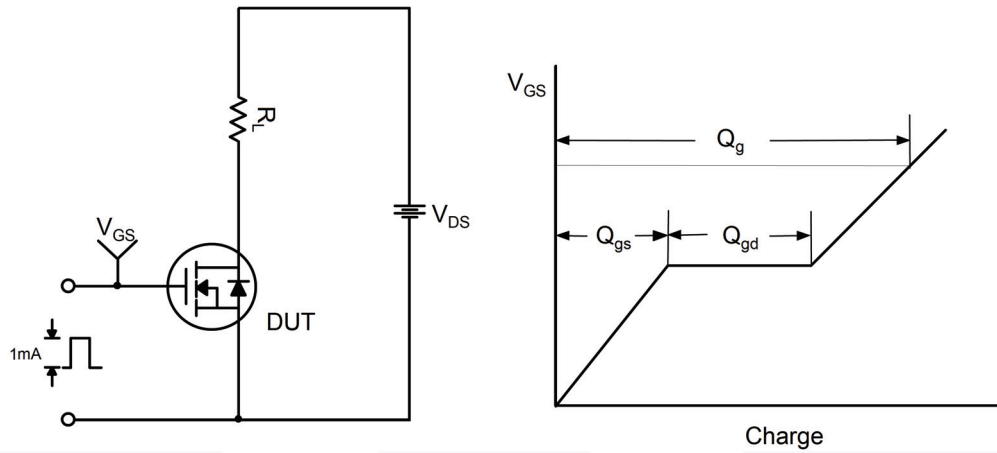

Figure 13. Resistive Switching Test Circuit & Waveforms



Figure 14. Unclamped Inductive Switching Test Circuit & Waveforms

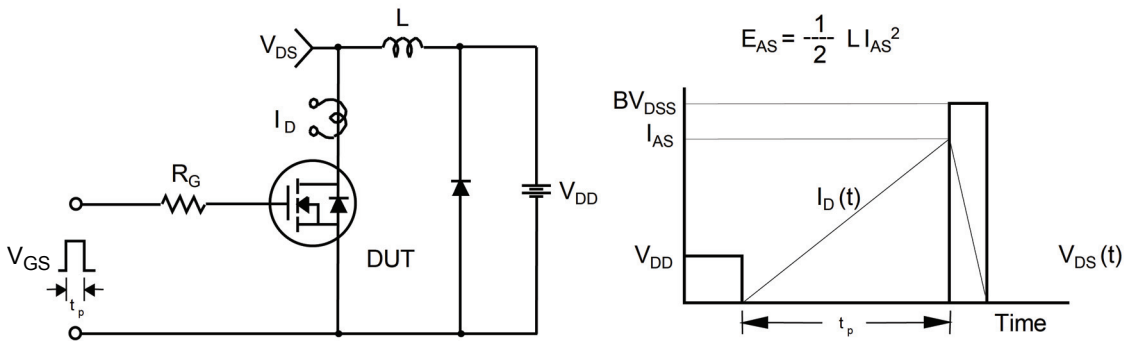
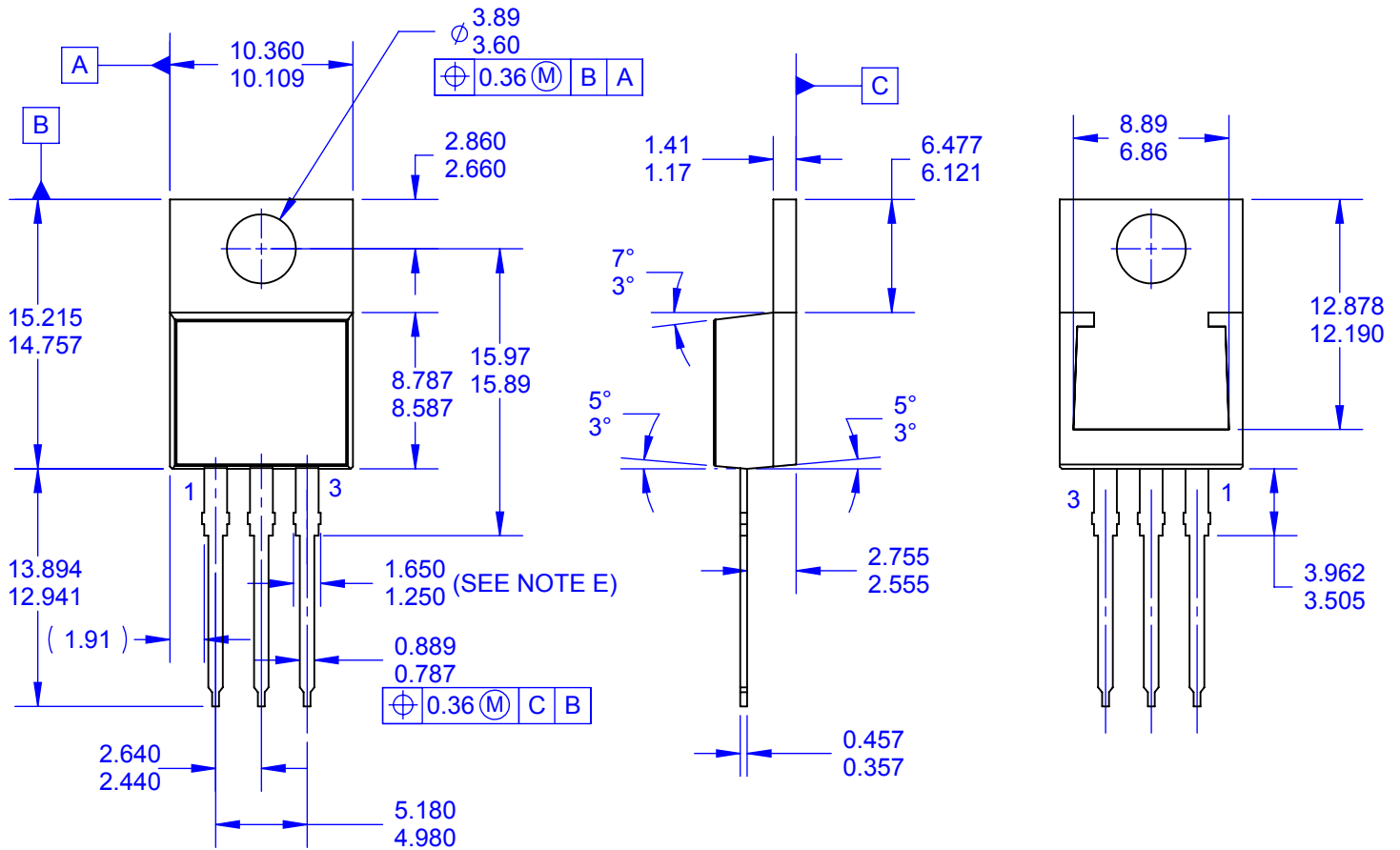

Figure 15. Peak Diode Recovery dv/dt Test Circuit & Waveforms





NOTES:

- A. PACKAGE REFERENCE: JEDEC TO220 VARIATION AB
- B. ALL DIMENSIONS ARE IN MILLIMETERS.
- C. DIMENSION AND TOLERANCE AS PER ASME Y14.5-2009.
- D. DIMENSIONS ARE EXCLUSIVE OF BURRS, MOLD FLASH AND TIE BAR PROTRUSIONS.
- E. MAX WIDTH FOR F102 DEVICE = 1.35mm.
- F. DRAWING FILE NAME: TO220T03REV4.
- G. FAIRCHILD SEMICONDUCTOR.

ON Semiconductor and  are trademarks of Semiconductor Components Industries, LLC dba ON Semiconductor or its subsidiaries in the United States and/or other countries. ON Semiconductor owns the rights to a number of patents, trademarks, copyrights, trade secrets, and other intellectual property. A listing of ON Semiconductor's product/patent coverage may be accessed at www.onsemi.com/site/pdf/Patent-Marking.pdf. ON Semiconductor reserves the right to make changes without further notice to any products herein. ON Semiconductor makes no warranty, representation or guarantee regarding the suitability of its products for any particular purpose, nor does ON Semiconductor assume any liability arising out of the application or use of any product or circuit, and specifically disclaims any and all liability, including without limitation special, consequential or incidental damages. Buyer is responsible for its products and applications using ON Semiconductor products, including compliance with all laws, regulations and safety requirements or standards, regardless of any support or applications information provided by ON Semiconductor. "Typical" parameters which may be provided in ON Semiconductor data sheets and/or specifications can and do vary in different applications and actual performance may vary over time. All operating parameters, including "Typicals" must be validated for each customer application by customer's technical experts. ON Semiconductor does not convey any license under its patent rights nor the rights of others. ON Semiconductor products are not designed, intended, or authorized for use as a critical component in life support systems or any FDA Class 3 medical devices or medical devices with a same or similar classification in a foreign jurisdiction or any devices intended for implantation in the human body. Should Buyer purchase or use ON Semiconductor products for any such unintended or unauthorized application, Buyer shall indemnify and hold ON Semiconductor and its officers, employees, subsidiaries, affiliates, and distributors harmless against all claims, costs, damages, and expenses, and reasonable attorney fees arising out of, directly or indirectly, any claim of personal injury or death associated with such unintended or unauthorized use, even if such claim alleges that ON Semiconductor was negligent regarding the design or manufacture of the part. ON Semiconductor is an Equal Opportunity/Affirmative Action Employer. This literature is subject to all applicable copyright laws and is not for resale in any manner.

PUBLICATION ORDERING INFORMATION

LITERATURE FULFILLMENT:

Literature Distribution Center for ON Semiconductor
19521 E. 32nd Pkwy, Aurora, Colorado 80011 USA
Phone: 303-675-2175 or 800-344-3860 Toll Free USA/Canada
Fax: 303-675-2176 or 800-344-3867 Toll Free USA/Canada
Email: orderlit@onsemi.com

N. American Technical Support: 800-282-9855 Toll Free
USA/Canada
Europe, Middle East and Africa Technical Support:
Phone: 421 33 790 2910
Japan Customer Focus Center
Phone: 81-3-5817-1050

ON Semiconductor Website: www.onsemi.com
Order Literature: <http://www.onsemi.com/orderlit>
For additional information, please contact your local
Sales Representative