

FCP125N65S3

MOSFET – Power, N-Channel, SUPERFET III, Easy Drive

650 V, 24 A, 125 mΩ

Description

SUPERFET III MOSFET is ON Semiconductor's brand-new high voltage super-junction (SJ) MOSFET family that is utilizing charge balance technology for outstanding low on-resistance and lower gate charge performance. This advanced technology is tailored to minimize conduction loss, provides superior switching performance, and withstand extreme dv/dt rate.

Consequently, SUPERFET III MOSFET Easy drive series helps manage EMI issues and allows for easier design implementation.

Features

- 700 V @ $T_J = 150^\circ\text{C}$
- Typ. $R_{DS(on)} = 105\text{ m}\Omega$
- Ultra Low Gate Charge (Typ. $Q_g = 46\text{ nC}$)
- Low Effective Output Capacitance (Typ. $C_{oss(eff.)} = 439\text{ pF}$)
- 100% Avalanche Tested
- These Devices are Pb-Free and are RoHS Compliant

Applications

- Telecom / Server Power Supplies
- Industrial Power Supplies
- UPS / Solar



ON Semiconductor®

www.onsemi.com

V_{DSS}	$R_{DS(ON)}\text{ MAX}$	$I_D\text{ MAX}$
650 V	125 mΩ @ 10 V	24 A

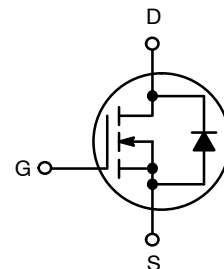

POWER MOSFET

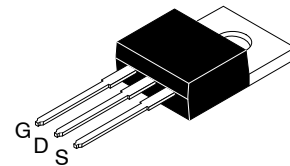

TO-220
CASE 340AT

MARKING DIAGRAM

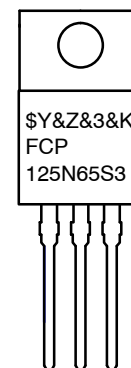

\$Y	= ON Semiconductor Logo
&Z	= Assembly Plant Code
&3	= Data Code (Year & Week)
&K	= Lot
FCP125N65S3	= Specific Device Code

ORDERING INFORMATION

See detailed ordering and shipping information on page 2 of this data sheet.

FCP125N65S3

ABSOLUTE MAXIMUM RATINGS ($T_C = 25^\circ\text{C}$, Unless otherwise noted)

Symbol	Parameter	Value	Unit
V_{DSS}	Drain to Source Voltage	650	V
V_{GSS}	Gate to Source Voltage	- DC	± 30
		- AC ($f > 1\text{ Hz}$)	± 30
I_D	Drain Current	- Continuous ($T_C = 25^\circ\text{C}$)	24
		- Continuous ($T_C = 100^\circ\text{C}$)	15
I_{DM}	Drain Current	- Pulsed (Note 1)	60
E_{AS}	Single Pulsed Avalanche Energy (Note 2)	115	mJ
I_{AS}	Avalanche Current (Note 2)	3.7	A
E_{AR}	Repetitive Avalanche Energy (Note 1)	1.81	mJ
dv/dt	MOSFET dv/dt	100	V/ns
	Peak Diode Recovery dv/dt (Note 3)	20	
P_D	Power Dissipation	($T_C = 25^\circ\text{C}$)	181
		- Derate Above 25°C	1.45
T_J, T_{STG}	Operating and Storage Temperature Range	-55 to +150	$^\circ\text{C}$
T_L	Maximum Lead Temperature for Soldering, 1/8" from Case for 5 seconds	300	$^\circ\text{C}$

Stresses exceeding those listed in the Maximum Ratings table may damage the device. If any of these limits are exceeded, device functionality should not be assumed, damage may occur and reliability may be affected.

1. Repetitive rating: pulse-width limited by maximum junction temperature.
2. $I_{AS} = 3.7\text{ A}$, $R_G = 25\ \Omega$, starting $T_J = 25^\circ\text{C}$.
3. $I_{SD} \leq 12\text{ A}$, $di/dt \leq 200\text{ A}/\mu\text{s}$, $V_{DD} \leq 400\text{ V}$, starting $T_J = 25^\circ\text{C}$.

THERMAL CHARACTERISTICS

Symbol	Parameter	Value	Unit
$R_{\theta JC}$	Thermal Resistance, Junction to Case, Max.	0.69	$^\circ\text{C}/\text{W}$
$R_{\theta JA}$	Thermal Resistance, Junction to Ambient, Max.	62.5	

PACKAGE MARKING AND ORDERING INFORMATION

Part Number	Top Marking	Package	Packing Method	Reel Size	Tape Width	Quantity
FCP125N65S3	FCP125N65S3	TO-220	Tube	N/A	N/A	50 Units

FCP125N65S3

ELECTRICAL CHARACTERISTICS ($T_C = 25^\circ\text{C}$ unless otherwise noted)

Symbol	Parameter	Test Conditions	Min.	Typ.	Max.	Unit
--------	-----------	-----------------	------	------	------	------

OFF CHARACTERISTICS

BV _{DSS}	Drain to Source Breakdown Voltage	V _{GS} = 0 V, I _D = 1 mA, T _J = 25°C	650			V
		V _{GS} = 0 V, I _D = 1 mA, T _J = 150°C	700			V
ΔBV _{DSS} / ΔT _J	Breakdown Voltage Temperature Coefficient	I _D = 1 mA, Referenced to 25°C		0.68		V/°C
I _{DSS}	Zero Gate Voltage Drain Current	V _{DS} = 650 V, V _{GS} = 0 V			1	μA
		V _{DS} = 520 V, T _C = 125°C		1.35		
I _{GSS}	Gate to Body Leakage Current	V _{GS} = ±30 V, V _{DS} = 0 V			±100	nA

ON CHARACTERISTICS

V _{GS(th)}	Gate Threshold Voltage	V _{GS} = V _{DS} , I _D = 0.59 mA	2.5		4.5	V
R _{DS(on)}	Static Drain to Source On Resistance	V _{GS} = 10 V, I _D = 12 A		105	125	mΩ
g _{FS}	Forward Transconductance	V _{DS} = 20 V, I _D = 12 A		16		S

DYNAMIC CHARACTERISTICS

C _{iss}	Input Capacitance	V _{DS} = 400 V, V _{GS} = 0 V, f = 1 MHz		1940		pF
C _{oss}	Output Capacitance			40		pF
C _{oss(eff.)}	Effective Output Capacitance	V _{DS} = 0 V to 400 V, V _{GS} = 0 V		439		pF
C _{oss(er.)}	Energy Related Output Capacitance	V _{DS} = 0 V to 400 V, V _{GS} = 0 V		62		pF
Q _{g(tot)}	Total Gate Charge at 10 V	V _{DS} = 400 V, I _D = 12 A, V _{GS} = 10 V (Note 4)		46		nC
Q _{gs}	Gate to Source Gate Charge			12		nC
Q _{gd}	Gate to Drain "Miller" Charge			19		nC
ESR	Equivalent Series Resistance	f = 1 MHz		4		Ω

SWITCHING CHARACTERISTICS

t _{d(on)}	Turn-On Delay Time	V _{DD} = 400 V, I _D = 12 A, V _{GS} = 10 V, R _g = 4.7 Ω (Note 4)		25		ns
t _r	Turn-On Rise Time			26		ns
t _{d(off)}	Turn-Off Delay Time			73		ns
t _f	Turn-Off Fall Time			17		ns

SOURCE-DRAIN DIODE CHARACTERISTICS

I _S	Maximum Continuous Source to Drain Diode Forward Current			24		A
I _{SM}	Maximum Pulsed Source to Drain Diode Forward Current			60		A
V _{SD}	Source to Drain Diode Forward Voltage	V _{GS} = 0 V, I _{SD} = 12 A			1.2	V
t _{rr}	Reverse Recovery Time	V _{DD} = 400 V, I _{SD} = 12 A, dI _F /dt = 100 A/μs		339		ns
Q _{rr}	Reverse Recovery Charge			5.7		μC

Product parametric performance is indicated in the Electrical Characteristics for the listed test conditions, unless otherwise noted. Product performance may not be indicated by the Electrical Characteristics if operated under different conditions.

4. Essentially independent of operating temperature typical characteristics.

TYPICAL PERFORMANCE CHARACTERISTICS

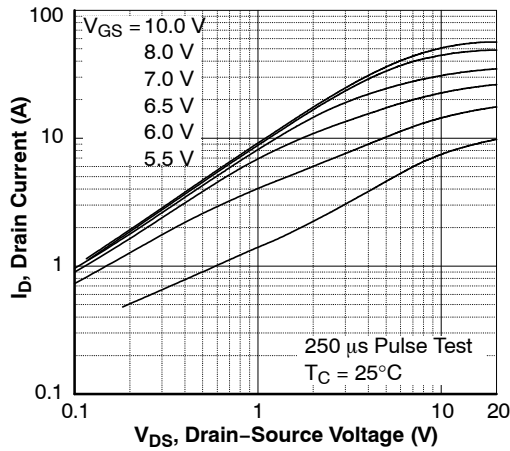

Figure 1. On-Region Characteristics

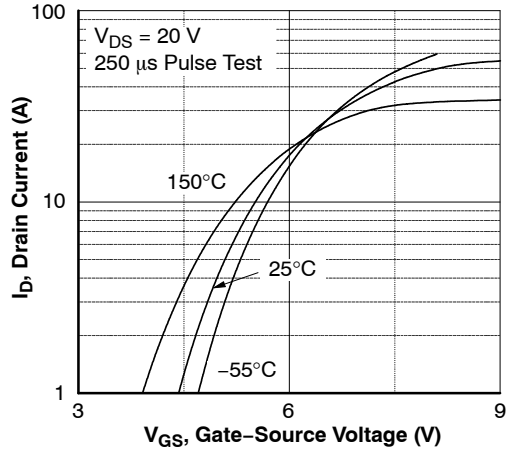

Figure 2. Transfer Characteristics

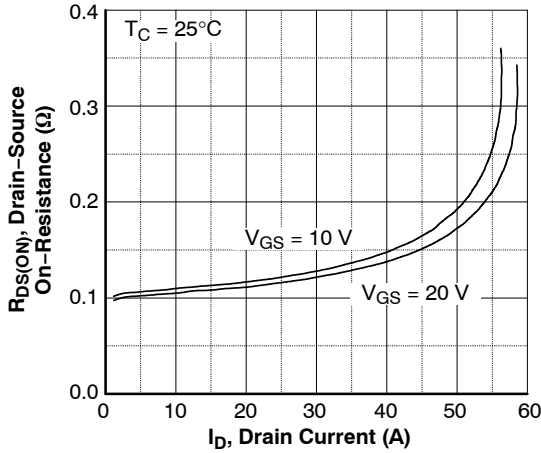

Figure 3. On-Resistance Variation vs. Drain Current and Gate Voltage

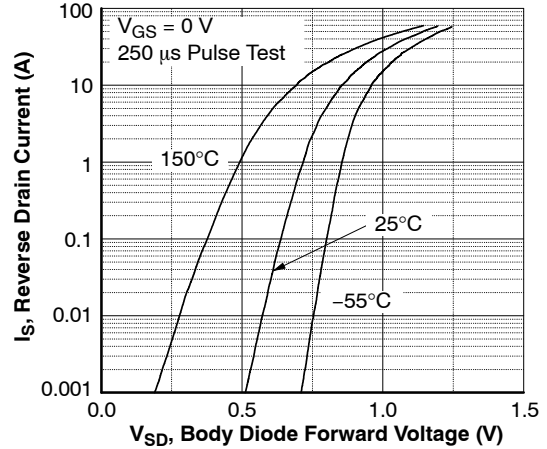

Figure 4. Body Diode Forward Voltage Variation vs. Source Current and Temperature

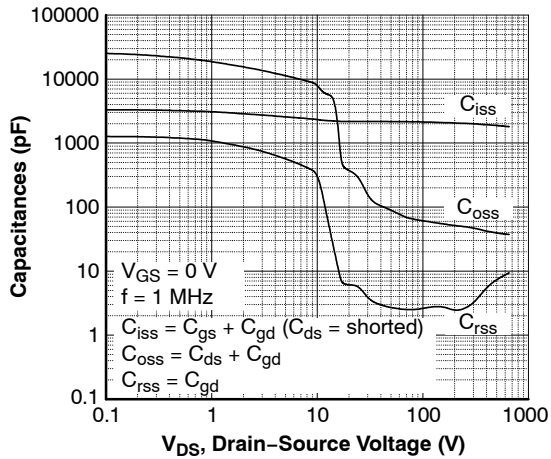

Figure 5. Capacitance Characteristics

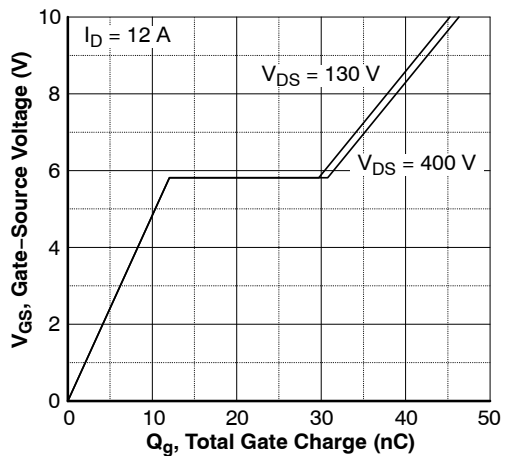

Figure 6. Gate Charge Characteristics

TYPICAL PERFORMANCE CHARACTERISTICS (continued)

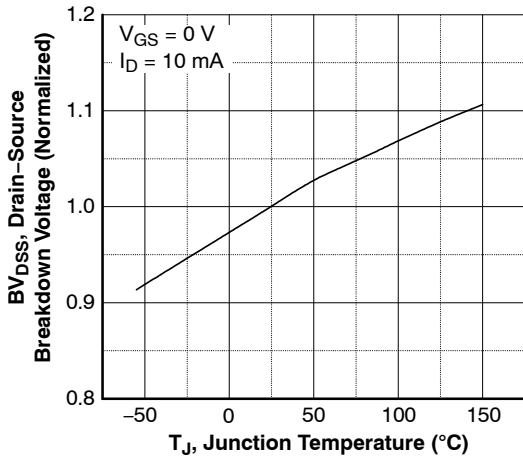

Figure 7. Breakdown Voltage Variation vs. Temperature

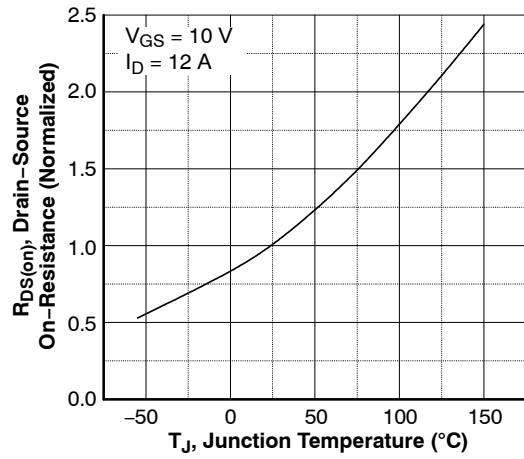

Figure 8. On-Resistance Variation vs. Temperature

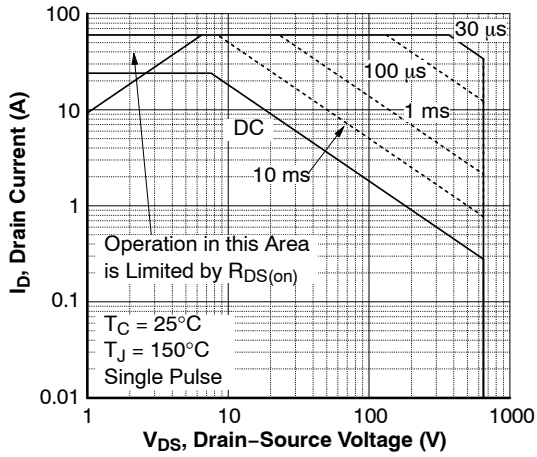

Figure 9. Maximum Safe Operating Area

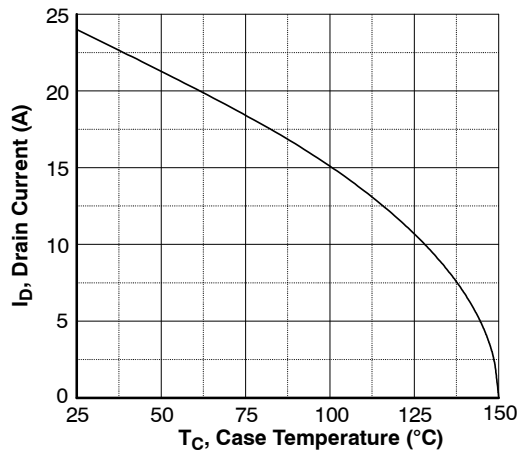

Figure 10. Maximum Drain Current vs. Case Temperature

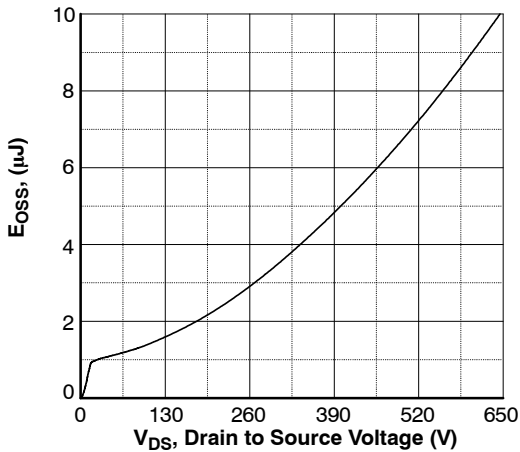

Figure 11. E_{OSS} vs. Drain to Source Voltage

FCP125N65S3

TYPICAL PERFORMANCE CHARACTERISTICS (continued)

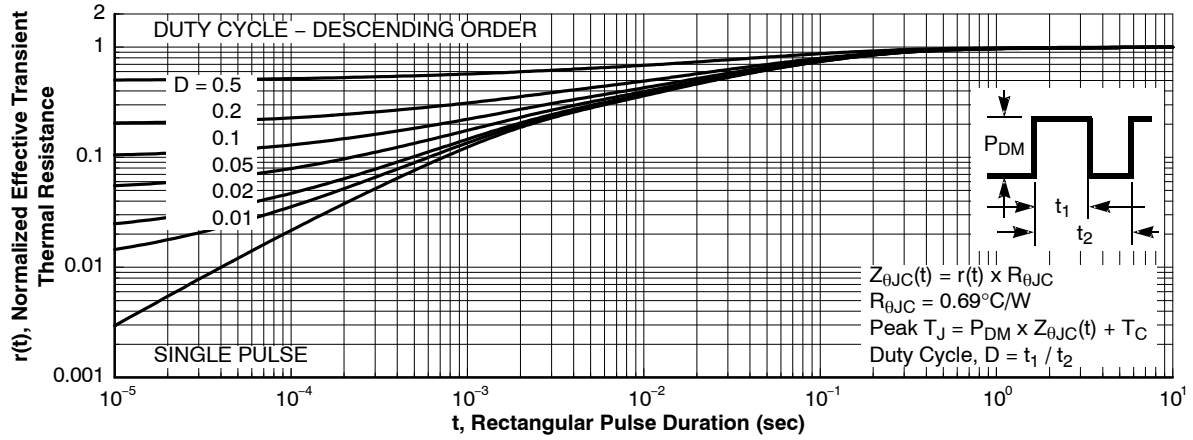

Figure 12. Transient Thermal Response Curve

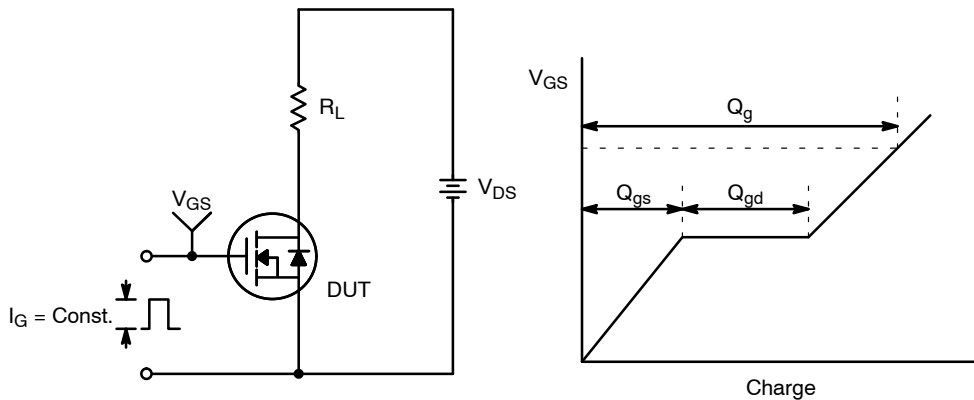

Figure 13. Gate Charge Test Circuit & Waveform

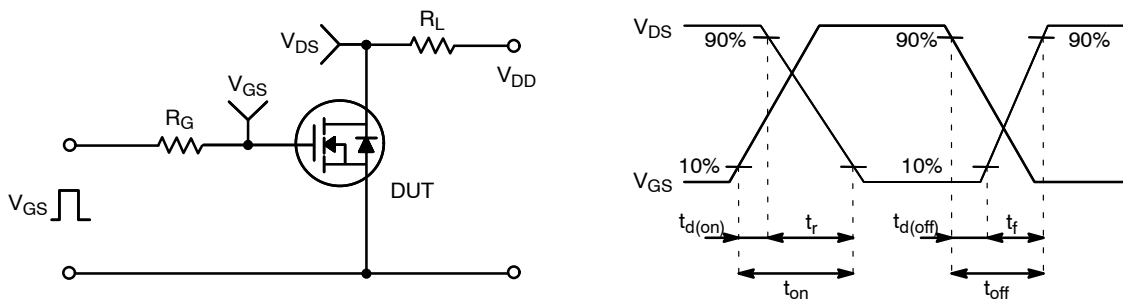

Figure 14. Resistive Switching Test Circuit & Waveforms

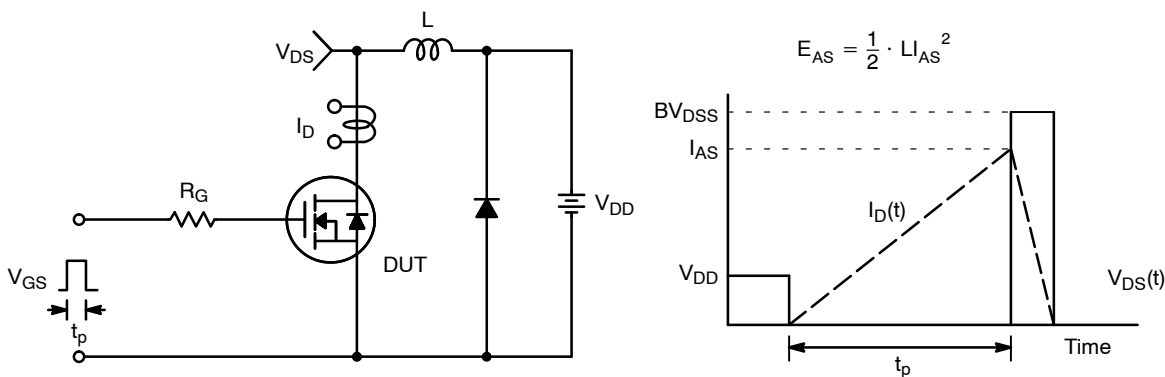

Figure 15. Unclamped Inductive Switching Test Circuit & Waveforms

FCP125N65S3



Figure 16. Peak Diode Recovery dv/dt Test Circuit & Waveforms

SUPERFET is a registered trademark of Semiconductor Components Industries, LLC (SCILLC) or its subsidiaries in the United States and/or other countries.

MECHANICAL CASE OUTLINE

PACKAGE DIMENSIONS

ON Semiconductor®



Scale 1:1

TO-220-3LD CASE 340AT ISSUE A

DATE 03 OCT 2017



NOTES:

- A) REFERENCE JEDEC, TO-220, VARIATION AB
- B) ALL DIMENSIONS ARE IN MILLIMETERS.
- C) DIMENSIONS COMMON TO ALL PACKAGE SUPPLIERS EXCEPT WHERE NOTED [].
- D) LOCATION OF MOLDED FEATURE MAY VARY (LOWER LEFT CORNER, LOWER CENTER AND CENTER OF THE PACKAGE)
- E) DOES NOT COMPLY JEDEC STANDARD VALUE.
- F) "A1" DIMENSIONS AS BELOW:
SINGLE GAUGE = 0.51 - 0.61
DUAL GAUGE = 1.10 - 1.45
- G) PRESENCE IS SUPPLIER DEPENDENT
- H) SUPPLIER DEPENDENT MOLD LOCKING HOLES IN HEATSINK.

DOCUMENT NUMBER:	98AON13818G	Electronic versions are uncontrolled except when accessed directly from the Document Repository. Printed versions are uncontrolled except when stamped "CONTROLLED COPY" in red.
DESCRIPTION:	TO-220-3LD	PAGE 1 OF 1

ON Semiconductor and are trademarks of Semiconductor Components Industries, LLC dba ON Semiconductor or its subsidiaries in the United States and/or other countries. ON Semiconductor reserves the right to make changes without further notice to any products herein. ON Semiconductor makes no warranty, representation or guarantee regarding the suitability of its products for any particular purpose, nor does ON Semiconductor assume any liability arising out of the application or use of any product or circuit, and specifically disclaims any and all liability, including without limitation special, consequential or incidental damages. ON Semiconductor does not convey any license under its patent rights nor the rights of others.

onsemi, **Onsemi**, and other names, marks, and brands are registered and/or common law trademarks of Semiconductor Components Industries, LLC dba "**onsemi**" or its affiliates and/or subsidiaries in the United States and/or other countries. **onsemi** owns the rights to a number of patents, trademarks, copyrights, trade secrets, and other intellectual property. A listing of **onsemi**'s product/patent coverage may be accessed at www.onsemi.com/site/pdf/Patent-Marking.pdf. **onsemi** reserves the right to make changes at any time to any products or information herein, without notice. The information herein is provided "as-is" and **onsemi** makes no warranty, representation or guarantee regarding the accuracy of the information, product features, availability, functionality, or suitability of its products for any particular purpose, nor does **onsemi** assume any liability arising out of the application or use of any product or circuit, and specifically disclaims any and all liability, including without limitation special, consequential or incidental damages. Buyer is responsible for its products and applications using **onsemi** products, including compliance with all laws, regulations and safety requirements or standards, regardless of any support or applications information provided by **onsemi**. "Typical" parameters which may be provided in **onsemi** data sheets and/or specifications can and do vary in different applications and actual performance may vary over time. All operating parameters, including "Typicals" must be validated for each customer application by customer's technical experts. **onsemi** does not convey any license under any of its intellectual property rights nor the rights of others. **onsemi** products are not designed, intended, or authorized for use as a critical component in life support systems or any FDA Class 3 medical devices or medical devices with a same or similar classification in a foreign jurisdiction or any devices intended for implantation in the human body. Should Buyer purchase or use **onsemi** products for any such unintended or unauthorized application, Buyer shall indemnify and hold **onsemi** and its officers, employees, subsidiaries, affiliates, and distributors harmless against all claims, costs, damages, and expenses, and reasonable attorney fees arising out of, directly or indirectly, any claim of personal injury or death associated with such unintended or unauthorized use, even if such claim alleges that **onsemi** was negligent regarding the design or manufacture of the part. **onsemi** is an Equal Opportunity/Affirmative Action Employer. This literature is subject to all applicable copyright laws and is not for resale in any manner.

ADDITIONAL INFORMATION

TECHNICAL PUBLICATIONS:

Technical Library: www.onsemi.com/design/resources/technical-documentation
onsemi Website: www.onsemi.com

ONLINE SUPPORT: www.onsemi.com/support

For additional information, please contact your local Sales Representative at www.onsemi.com/support/sales