

IGBT - Field Stop

600 V, 60 A

FGH60N60SMD-F085

Description

Using Novel Field Stop IGBT Technology, ON Semiconductor's new series of Field Stop Trench IGBTs offer the optimum performance for Automotive chargers, Solar Inverter, UPS and Digital Power Generator where low conduction and switching losses are essential.

Features

- Maximum Junction Temperature: $T_J = 175^\circ\text{C}$
- Positive Temperature Co-efficient for easy Parallel Operating
- High Current Capability
- Low Saturation Voltage: $V_{CE(sat)} = 1.8\text{ V (Typ.) @ } I_C = 60\text{ A}$
- High Input Impedance
- Tightened Parameter Distribution
- This Device is Pb-Free and is RoHS Compliant
- Qualified to Automotive Requirements of AEC-Q101

Applications

- Automotive Chargers, Converters, High Voltage Auxiliaries
- Solar Inverters, UPS, SMPS, PFC



ON Semiconductor®

www.onsemi.com

| | |
|-----------|-------|
| V_{CES} | I_C |
| 600 V | 60 A |

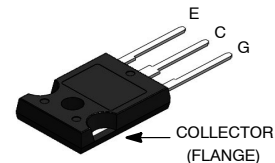
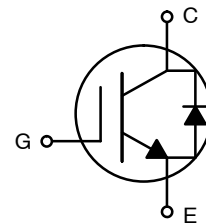

TO-247-3LD
CASE 340CK

MARKING DIAGRAM

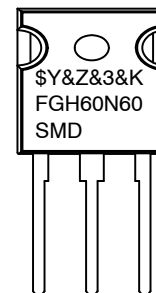

| | |
|-------------|-------------------------|
| \$Y | = ON Semiconductor Logo |
| &Z | = Assembly Plant Code |
| &3 | = Numeric Date Code |
| &K | = Lot Code |
| FGH60N60SMD | = Specific Device Code |

ORDERING INFORMATION

See detailed ordering and shipping information on page 2 of this data sheet.

FGH60N60SMD-F085

ABSOLUTE MAXIMUM RATINGS

| Symbol | Description | Ratings | Unit |
|-------------------|---|---------------------------|------------------|
| V_{CES} | Collector to Emitter Voltage | 600 | V |
| V_{GES} | Gate to Emitter Voltage | ± 20 | V |
| I_C | Collector Current | $T_C = 25^\circ\text{C}$ | A |
| | | $T_C = 100^\circ\text{C}$ | A |
| I_{CM} (Note 1) | Pulsed Collector Current | 180 | A |
| I_F | Diode Forward Current | $T_C = 25^\circ\text{C}$ | A |
| | | $T_C = 100^\circ\text{C}$ | A |
| I_{FM} (Note 1) | Pulsed Diode Maximum Forward Current | 180 | A |
| P_D | Maximum Power Dissipation | $T_C = 25^\circ\text{C}$ | W |
| | | $T_C = 100^\circ\text{C}$ | W |
| T_J | Operating Junction Temperature | -55 to +175 | $^\circ\text{C}$ |
| T_{STG} | Storage Temperature Range | -55 to +175 | $^\circ\text{C}$ |
| T_L | Maximum Lead Temp. for Soldering Purposes, 1/8" from Case for 5 Seconds | 300 | $^\circ\text{C}$ |

Stresses exceeding those listed in the Maximum Ratings table may damage the device. If any of these limits are exceeded, device functionality should not be assumed, damage may occur and reliability may be affected.

1. Repetitive rating: Pulse width limited by max. junction temperature.

THERMAL CHARACTERISTICS

| Symbol | Parameter | Max. | Unit |
|------------------------------------|--|------|---------------------------|
| $R_{\theta JC}$ (IGBT) (Note 2) | Thermal Resistance, Junction to Case | 0.25 | $^\circ\text{C}/\text{W}$ |
| $R_{\theta JC}$ (Diode) | Thermal Resistance, Junction to Case | 1.1 | $^\circ\text{C}/\text{W}$ |
| $R_{\theta JA}$ | Thermal Resistance, Junction to Ambient (PCB Mount) (Note 2) | 45 | $^\circ\text{C}/\text{W}$ |

2. $R_{\theta jc}$ for TO-247 : according to Mil standard 883-1012 test method. $R_{\theta ja}$ for TO-247 : according to JESD51-2, test method environmental condition and JESD51-10, test boards for through hole perimeter leaded package thermal measurements. JESD51-3 : Low Effective Thermal Conductivity Test Board for Leaded Surface Mount Package.

PACKAGE MARKING AND ORDERING INFORMATION

| Device Marking | Device | Package | Packing Method | Qty per Tube |
|----------------|------------------|---------|----------------|--------------|
| FGH60N60SMD | FGH60N60SMD-F085 | TO-247 | Tube | 30ea |

FGH60N60SMD-F085

ELECTRICAL CHARACTERISTICS OF THE IGBT

| Symbol | Parameter | Test Conditions | Min. | Typ. | Max. | Unit |
|--------|-----------|-----------------|------|------|------|------|
|--------|-----------|-----------------|------|------|------|------|

OFF CHARACTERISTICS

| | | | | | | |
|--------------------------------|--|---|-----|------|------|---------------|
| BV_{CES} | Collector to Emitter Breakdown Voltage | $V_{GE} = 0\text{ V}, I_C = 250\ \mu\text{A}$ | 600 | - | - | V |
| $\Delta BV_{CES} / \Delta T_J$ | Temperature Coefficient of Breakdown Voltage | $V_{GE} = 0\text{ V}, I_C = 250\ \mu\text{A}$ | - | 0.22 | - | V/°C |
| I_{CES} | Collector Cut-Off Current | $V_{CE} = V_{CES}, V_{GE} = 0\text{ V}$ | - | - | 250 | μA |
| | | I_{CES} at 80 % * BV_{CES} , 175 °C | - | - | 1100 | |
| I_{GES} | G-E Leakage Current | $V_{GE} = V_{GES}, V_{CE} = 0\text{ V}$ | - | - | ±400 | nA |

ON CHARACTERISTICS

| | | | | | | |
|---------------|---|---|-----|------|-----|---|
| $V_{GE(th)}$ | G-E Threshold Voltage | $I_C = 250\ \mu\text{A}, V_{CE} = V_{GE}$ | 3.5 | 4.7 | 6.0 | V |
| $V_{CE(sat)}$ | Collector to Emitter Saturation Voltage | $I_C = 60\text{ A}, V_{GE} = 15\text{ V},$ | - | 1.8 | 2.5 | V |
| | | $I_C = 60\text{ A}, V_{GE} = 15\text{ V},$ $T_C = 175^\circ\text{C}$ | - | 2.14 | - | V |

DYNAMIC CHARACTERISTICS

| | | | | | | |
|-----------|------------------------------|--|---|------|------|----|
| C_{ies} | Input Capacitance | $V_{CE} = 30\text{ V}, V_{GE} = 0\text{ V},$ $f = 1\text{ MHz}$ | - | 2780 | 3700 | pF |
| C_{oes} | Output Capacitance | | - | 260 | 345 | pF |
| C_{res} | Reverse Transfer Capacitance | | - | 80 | 110 | pF |

SWITCHING CHARACTERISTICS

| | | | | | | |
|--------------|--------------------------|--|---|------|------|----|
| $T_{d(on)}$ | Turn-On Delay Time | $V_{CC} = 400\text{ V}, I_C = 60\text{ A},$ $R_G = 3\ \Omega, V_{GE} = 15\text{ V},$ Inductive Load, $T_C = 25^\circ\text{C}$ | - | 22 | 29 | ns |
| T_r | Rise Time | | - | 46 | 60 | ns |
| $T_{d(off)}$ | Turn-Off Delay Time | | - | 116 | 151 | ns |
| T_f | Fall Time | | - | 14 | 18 | ns |
| E_{on} | Turn-On Switching Loss | | - | 1.59 | 2.23 | mJ |
| E_{off} | Turn-Off Switching Loss | | - | 0.39 | 0.55 | mJ |
| E_{ts} | Total Switching Loss | | - | 1.98 | 2.78 | mJ |
| $T_{d(on)}$ | Turn-On Delay Time | $V_{CC} = 400\text{ V}, I_C = 60\text{ A},$ $R_G = 3\ \Omega, V_{GE} = 15\text{ V},$ Inductive Load, $T_C = 175^\circ\text{C}$ | - | 22 | 28 | ns |
| T_r | Rise Time | | - | 44 | 58 | ns |
| $T_{d(off)}$ | Turn-Off Delay Time | | - | 124 | 161 | ns |
| T_f | Fall Time | | - | 15 | 20 | ns |
| E_{on} | Turn-On Switching Loss | | - | 2.41 | 3.13 | mJ |
| E_{off} | Turn-Off Switching Loss | | - | 1.08 | 1.42 | mJ |
| E_{ts} | Total Switching Loss | | - | 3.49 | 4.55 | mJ |
| Q_g | Total Gate Charge | $V_{CE} = 400\text{ V}, I_C = 60\text{ A},$ $V_{GE} = 15\text{ V}$ | - | 187 | 280 | nC |
| Q_{ge} | Gate to Emitter Charge | | - | 20 | 29 | nC |
| Q_{gc} | Gate to Collector Charge | | - | 92 | 138 | nC |

Product parametric performance is indicated in the Electrical Characteristics for the listed test conditions, unless otherwise noted. Product performance may not be indicated by the Electrical Characteristics if operated under different conditions.

FGH60N60SMD-F085

ELECTRICAL CHARACTERISTICS OF THE DIODE ($T_C = 25^\circ\text{C}$ unless otherwise noted)

| Symbol | Parameter | Test Conditions | Min | Typ | Max | Unit | |
|----------|-------------------------------|--|---------------------------|-----|------|------|----|
| V_{FM} | Diode Forward Voltage | $I_F = 30\text{ A}$ | $T_C = 25^\circ\text{C}$ | - | 2.1 | 2.7 | V |
| | | | $T_C = 175^\circ\text{C}$ | - | 1.48 | - | |
| T_{rr} | Diode Reverse Recovery Time | $I_F = 30\text{ A},$ $di_F/dt = 200\text{ A}/\mu\text{s}$ | $T_C = 25^\circ\text{C}$ | - | 33 | 42 | ns |
| | | | $T_C = 175^\circ\text{C}$ | - | 115 | - | |
| Q_{rr} | Diode Reverse Recovery Charge | | $T_C = 25^\circ\text{C}$ | - | 53 | 69 | nC |
| | | | $T_C = 175^\circ\text{C}$ | - | 606 | - | |

Product parametric performance is indicated in the Electrical Characteristics for the listed test conditions, unless otherwise noted. Product performance may not be indicated by the Electrical Characteristics if operated under different conditions.

TYPICAL PERFORMANCE CHARACTERISTICS

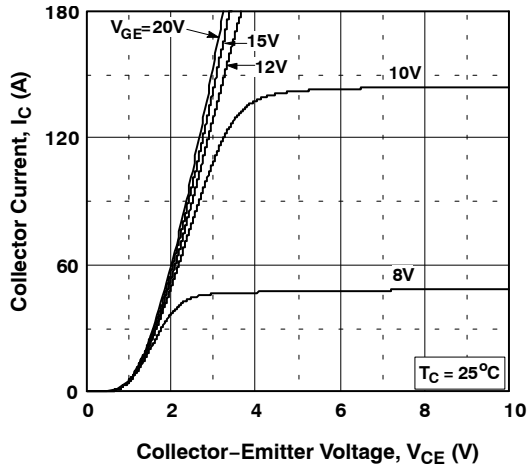

Figure 1. Typical Output Characteristics

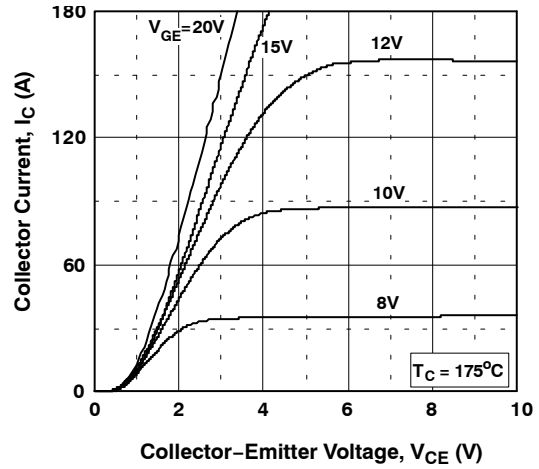

Figure 2. Typical Output Characteristics

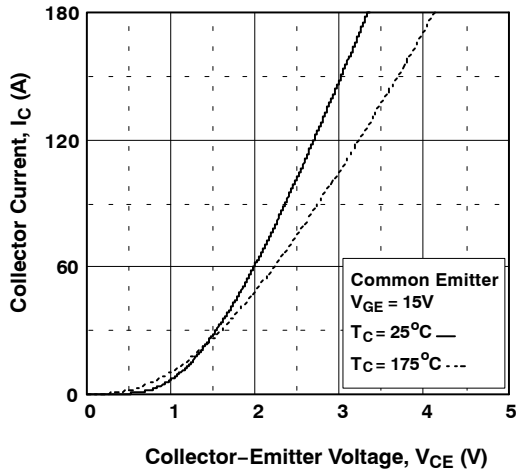

Figure 3. Typical Saturation Voltage Characteristics

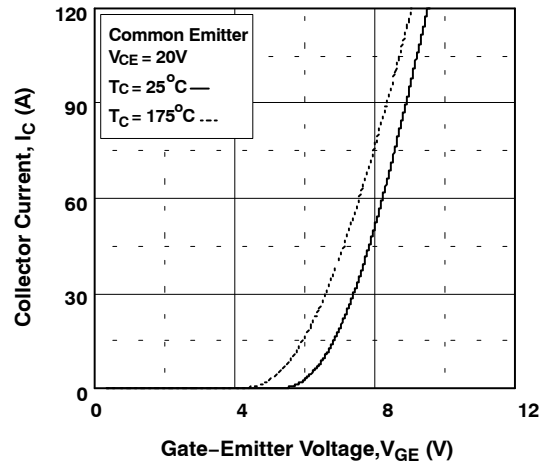

Figure 4. Transfer Characteristics

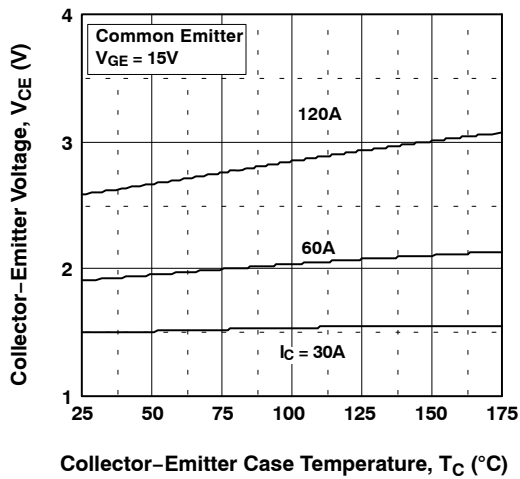

Figure 5. Saturation Voltage vs. Case Temperature at Variant Current Level

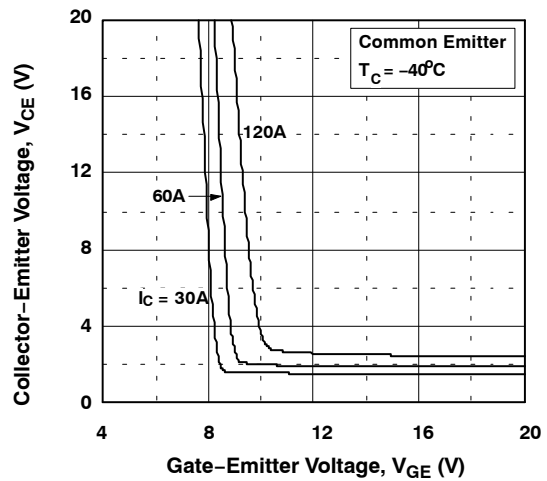

Figure 6. Saturation Voltage vs. V_{GE}

TYPICAL PERFORMANCE CHARACTERISTICS (Continued)

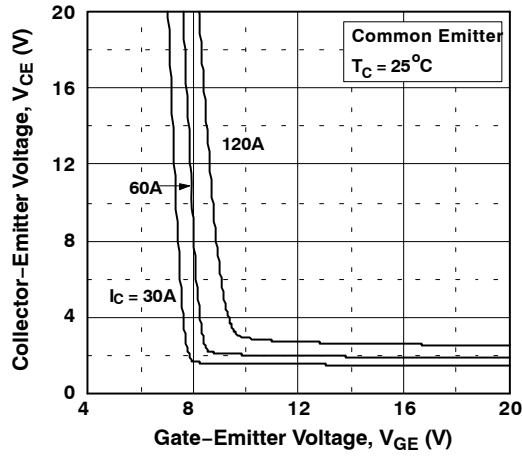

Figure 7. Saturation Voltage vs. V_{GE}

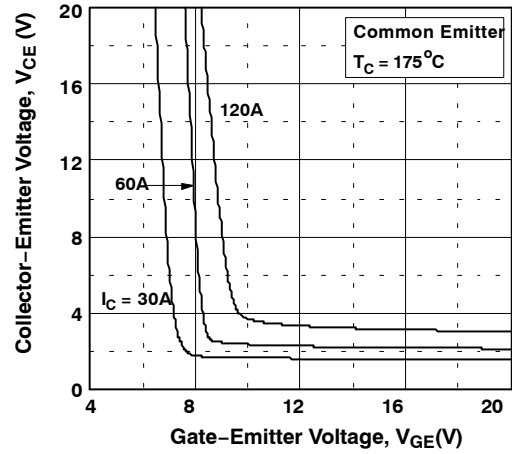

Figure 8. Saturation Voltage vs. V_{GE}

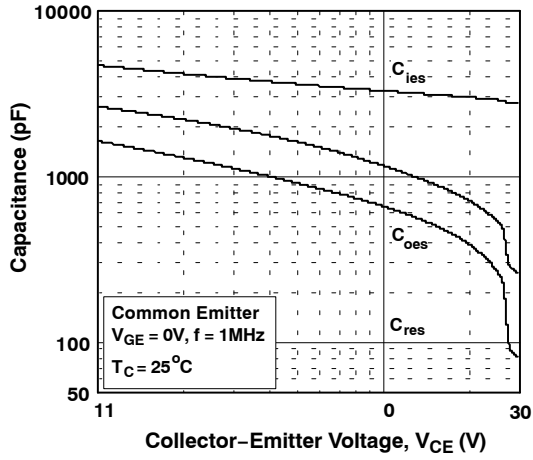

Figure 9. Capacitance Characteristics

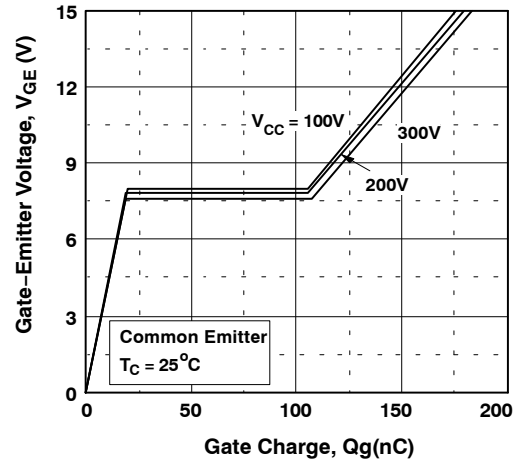

Figure 10. Gate Charge Characteristics

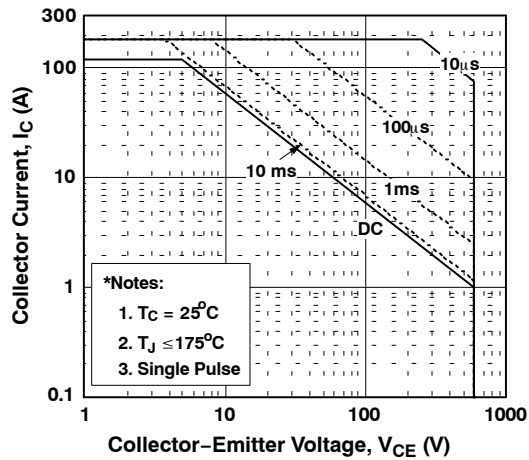

Figure 11. SOA Characteristics

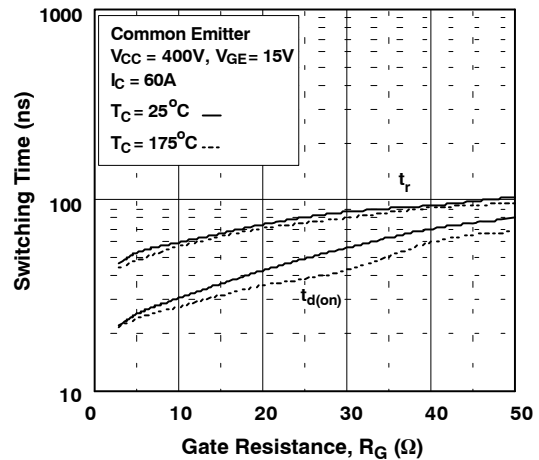

Figure 12. Turn-on Characteristics vs. Gate Resistance

TYPICAL PERFORMANCE CHARACTERISTICS (Continued)

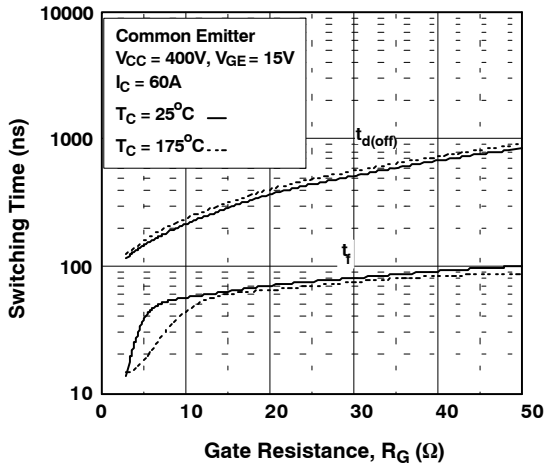

Figure 13. Turn-off Characteristics vs. Gate Resistance

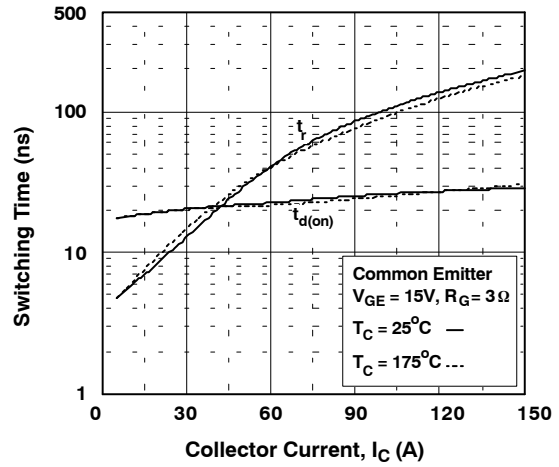

Figure 14. Turn-on Characteristics vs. Collector Current

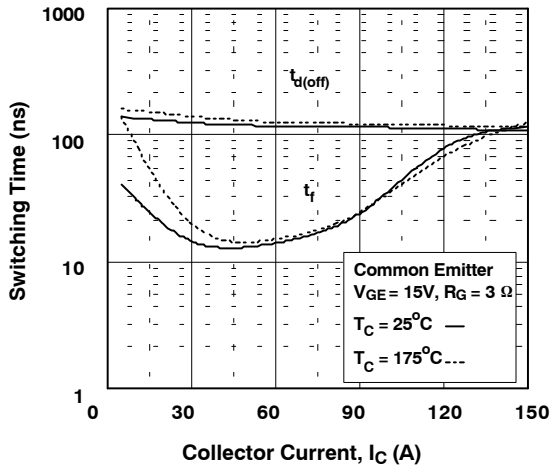

Figure 15. Turn-off Characteristics vs. Collector Current

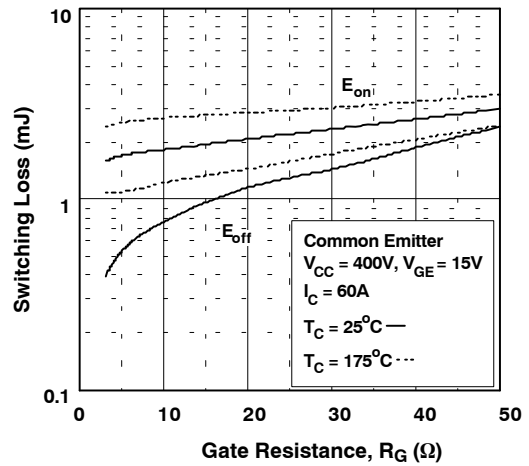

Figure 16. Switching Loss vs. Gate Resistance

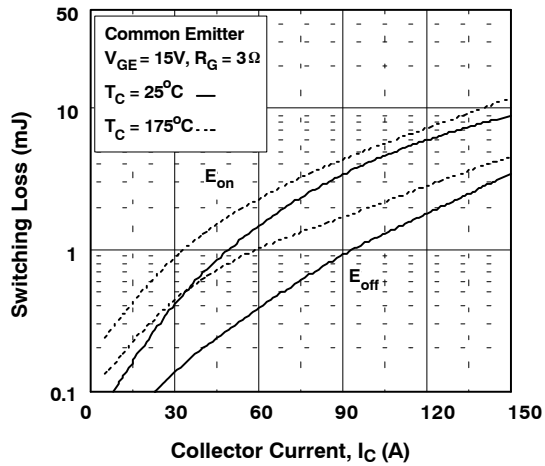

Figure 17. Switching Loss vs. Collector Current

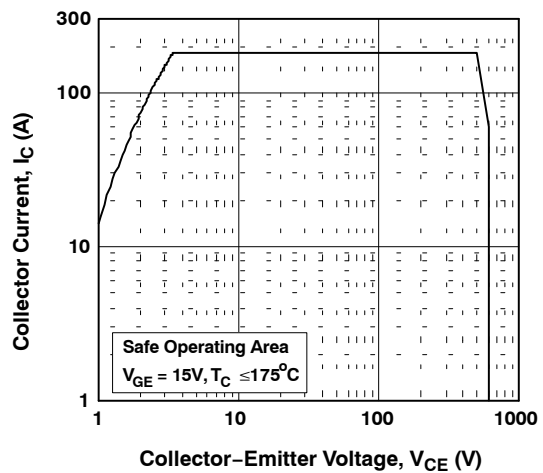

Figure 18. Turn Off Switching SOA Characteristics

TYPICAL PERFORMANCE CHARACTERISTICS (Continued)

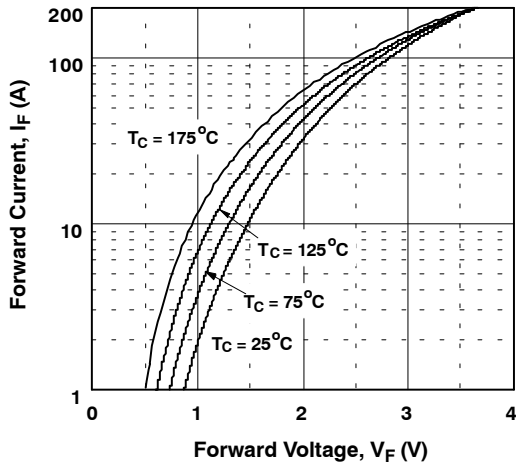

Figure 19. Forward Characteristics

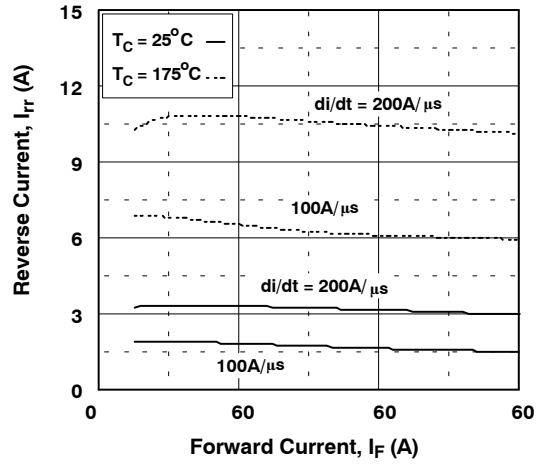

Figure 20. Reverse Recovery Current

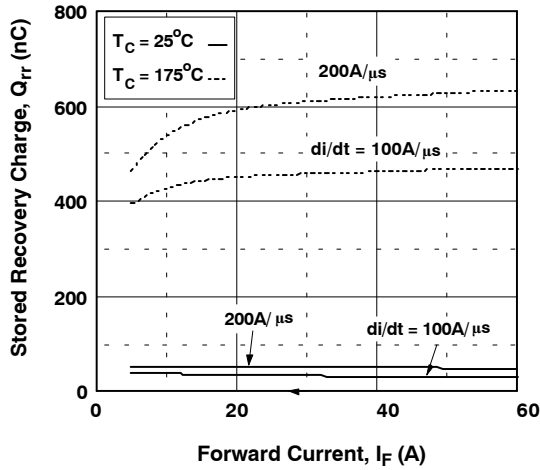

Figure 21. Stored Charge

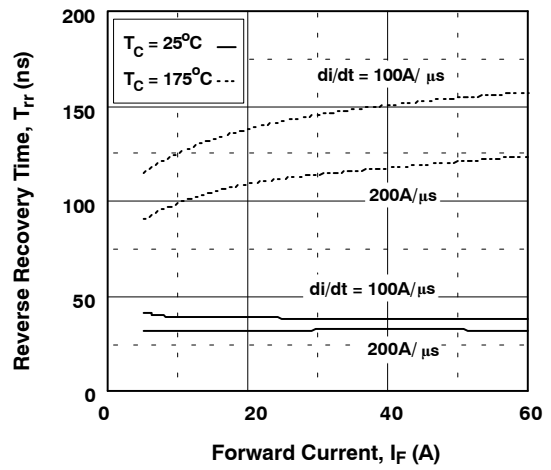

Figure 22. Reverse Recovery Time

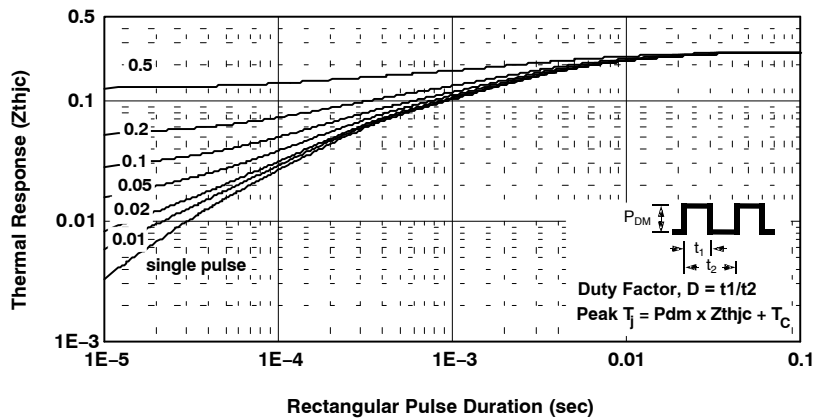
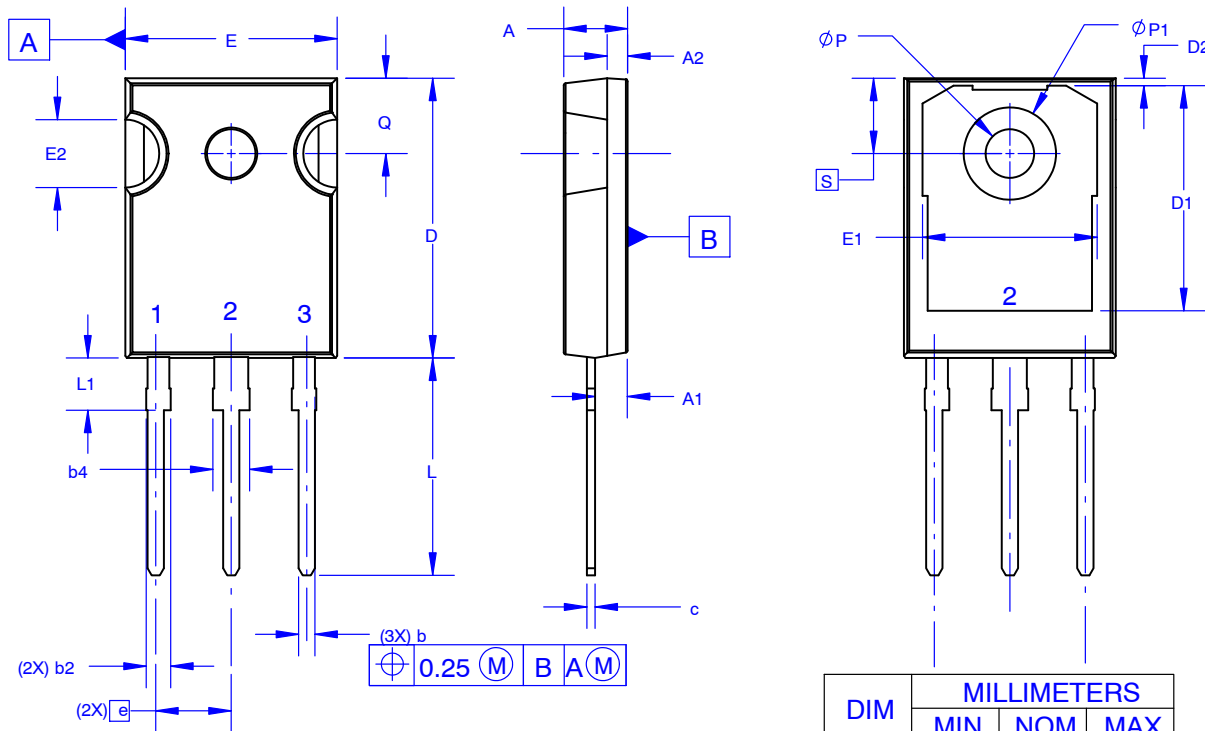

Figure 23. Transient Thermal Impedance of IGBT



TO-247-3LD SHORT LEAD
CASE 340CK
ISSUE A

DATE 31 JAN 2019



NOTES: UNLESS OTHERWISE SPECIFIED.

- A. DIMENSIONS ARE EXCLUSIVE OF BURRS, MOLD FLASH, AND TIE BAR EXTRUSIONS.
- B. ALL DIMENSIONS ARE IN MILLIMETERS.
- C. DRAWING CONFORMS TO ASME Y14.5 - 2009.
- D. DIMENSION A1 TO BE MEASURED IN THE REGION DEFINED BY L1.
- E. LEAD FINISH IS UNCONTROLLED IN THE REGION DEFINED BY L1.

GENERIC MARKING DIAGRAM*

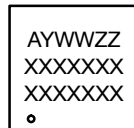

- XXXX = Specific Device Code
- A = Assembly Location
- Y = Year
- WW = Work Week
- ZZ = Assembly Lot Code

*This information is generic. Please refer to device data sheet for actual part marking. Pb-Free indicator, "G" or microdot "μ", may or may not be present. Some products may not follow the Generic Marking.

| DIM | MILLIMETERS | | |
|-----|-------------|-------|-------|
| | MIN | NOM | MAX |
| A | 4.58 | 4.70 | 4.82 |
| A1 | 2.20 | 2.40 | 2.60 |
| A2 | 1.40 | 1.50 | 1.60 |
| b | 1.17 | 1.26 | 1.35 |
| b2 | 1.53 | 1.65 | 1.77 |
| b4 | 2.42 | 2.54 | 2.66 |
| c | 0.51 | 0.61 | 0.71 |
| D | 20.32 | 20.57 | 20.82 |
| D1 | 13.08 | ~ | ~ |
| D2 | 0.51 | 0.93 | 1.35 |
| E | 15.37 | 15.62 | 15.87 |
| E1 | 12.81 | ~ | ~ |
| E2 | 4.96 | 5.08 | 5.20 |
| e | ~ | 5.56 | ~ |
| L | 15.75 | 16.00 | 16.25 |
| L1 | 3.69 | 3.81 | 3.93 |
| ØP | 3.51 | 3.58 | 3.65 |
| ØP1 | 6.60 | 6.80 | 7.00 |
| Q | 5.34 | 5.46 | 5.58 |
| S | 5.34 | 5.46 | 5.58 |

| | | |
|-------------------------|-----------------------|--|
| DOCUMENT NUMBER: | 98AON13851G | Electronic versions are uncontrolled except when accessed directly from the Document Repository. Printed versions are uncontrolled except when stamped "CONTROLLED COPY" in red. |
| DESCRIPTION: | TO-247-3LD SHORT LEAD | PAGE 1 OF 1 |

ON Semiconductor and are trademarks of Semiconductor Components Industries, LLC dba ON Semiconductor or its subsidiaries in the United States and/or other countries. ON Semiconductor reserves the right to make changes without further notice to any products herein. ON Semiconductor makes no warranty, representation or guarantee regarding the suitability of its products for any particular purpose, nor does ON Semiconductor assume any liability arising out of the application or use of any product or circuit, and specifically disclaims any and all liability, including without limitation special, consequential or incidental damages. ON Semiconductor does not convey any license under its patent rights nor the rights of others.

onsemi, **Onsemi**, and other names, marks, and brands are registered and/or common law trademarks of Semiconductor Components Industries, LLC dba "**onsemi**" or its affiliates and/or subsidiaries in the United States and/or other countries. **onsemi** owns the rights to a number of patents, trademarks, copyrights, trade secrets, and other intellectual property. A listing of **onsemi**'s product/patent coverage may be accessed at www.onsemi.com/site/pdf/Patent-Marking.pdf. **onsemi** reserves the right to make changes at any time to any products or information herein, without notice. The information herein is provided "as-is" and **onsemi** makes no warranty, representation or guarantee regarding the accuracy of the information, product features, availability, functionality, or suitability of its products for any particular purpose, nor does **onsemi** assume any liability arising out of the application or use of any product or circuit, and specifically disclaims any and all liability, including without limitation special, consequential or incidental damages. Buyer is responsible for its products and applications using **onsemi** products, including compliance with all laws, regulations and safety requirements or standards, regardless of any support or applications information provided by **onsemi**. "Typical" parameters which may be provided in **onsemi** data sheets and/or specifications can and do vary in different applications and actual performance may vary over time. All operating parameters, including "Typicals" must be validated for each customer application by customer's technical experts. **onsemi** does not convey any license under any of its intellectual property rights nor the rights of others. **onsemi** products are not designed, intended, or authorized for use as a critical component in life support systems or any FDA Class 3 medical devices or medical devices with a same or similar classification in a foreign jurisdiction or any devices intended for implantation in the human body. Should Buyer purchase or use **onsemi** products for any such unintended or unauthorized application, Buyer shall indemnify and hold **onsemi** and its officers, employees, subsidiaries, affiliates, and distributors harmless against all claims, costs, damages, and expenses, and reasonable attorney fees arising out of, directly or indirectly, any claim of personal injury or death associated with such unintended or unauthorized use, even if such claim alleges that **onsemi** was negligent regarding the design or manufacture of the part. **onsemi** is an Equal Opportunity/Affirmative Action Employer. This literature is subject to all applicable copyright laws and is not for resale in any manner.

ADDITIONAL INFORMATION

TECHNICAL PUBLICATIONS:

Technical Library: www.onsemi.com/design/resources/technical-documentation
onsemi Website: www.onsemi.com

ONLINE SUPPORT: www.onsemi.com/support

For additional information, please contact your local Sales Representative at www.onsemi.com/support/sales

