

2.5 A Output Current, High-Speed, MOSFET/IGBT Gate Drive Optocoupler in OPTOPLANAR® Wide-Body SOP 5-Pin

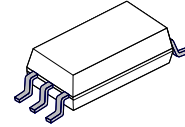

SOIC6 W LESS PIN 2
CASE 752AG

FOD8384

Description

The FOD8384 is a 2.5 A output current gate drive optocoupler capable of driving medium-power IGBT/ MOSFETs. It is ideally suited for fast-switching driving of power IGBT and MOSFET used in motor-control inverter applications and high-performance power systems.

The FOD8384 utilizes onsemi's OPTOPLANAR coplanar packaging technology and optimized IC design to achieve reliable high-insulation voltage and high-noise immunity.

It consists of an Aluminum Gallium Arsenide (AlGaAs) Light-Emitting Diode (LED) optically coupled to an integrated circuit with a high-speed driver for push-pull MOSFET output stage. The device is housed in a wide body, 5-pin, small-outline, plastic package.

Features

- Reliable and High-Voltage Insulation with Greater than 8 mm Creepage and Clearance Distance and 0.5 mm Internal Insulation Distance
- 2.5 A Output Current Driving Capability for Medium-Power IGBT/MOSFET
 - ◆ P-Channel MOSFET at Output Stage Enables Output Voltage Swing Close to Supply Rail
- 35 kV/μs Minimum Common Mode Rejection
- Wide Supply Voltage Range: 15 V to 30 V
- Fast Switching Speed Over Full Operating Temperature Range
 - ◆ 210 ns Maximum Propagation Delay
 - ◆ 65 ns Maximum Pulse-Width Distortion
- Under-Voltage Lockout (UVLO) with Hysteresis
- Extended Industrial Temperature Range: -40°C to 100°C
- Safety and Regulatory Approvals:
 - ◆ UL1577, 5,000 VACRMS for 1 Minute
 - ◆ DIN-EN/IEC60747-5-5, 1,414 V Peak Working
- Insulation Voltage
- These are Pb-Free Devices

Applications

- AC and Brushless DC Motor Drives
- Industrial Inverter
- Uninterruptible Power Supply
- Induction Heating
- Isolated IGBT/Power MOSFET Gate Drive

MARKING DIAGRAM

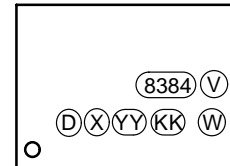

- 8384 = Device number, e.g., '8384' for FOD8384
- V = DIN EN/IEC60747-5-5 Option (Only Appears on Component Ordered with This Option)
- D = Plant Code
- X = Last Digit Year Code
- YY = Two-digit Work Week
- KK = Lot Traceability Code
- W = Package Assembly Code

FUNCTIONAL SCHEMATIC

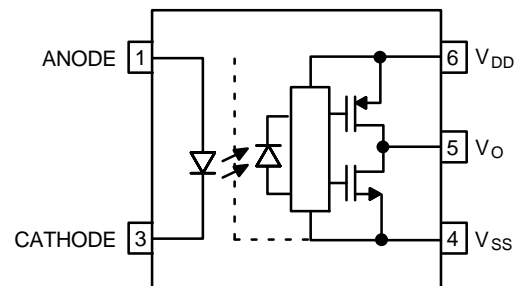

ORDERING INFORMATION

See detailed ordering and shipping information on page 14 of this data sheet.

Related Resources

- [FOD3184](#) – 3 A Output Current, High-Speed MOSFET/IGBT Gate Drive Optocoupler Datasheet
- <https://www.onsemi.com/products/interfaces/igbt-mosfet-gate-drivers-optocouplers>

FOD8384

TRUTH TABLE

LED	$V_{DD} - V_{SS}$ "Positive Going" (Turn-on)	$V_{DD} - V_{SS}$ "Positive Going" (Turn-off)	V_O
Off	0 V to 30 V	0 V to 30 V	LOW
On	0 V to 11.5 V	0 V to 10 V	LOW
On	11.5 V to 14.5 V	10 V to 13 V	Transition
On	14.5 V to 30 V	13 V to 30 V	HIGH

Pin Configuration

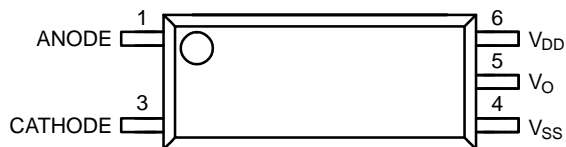

Figure 1. Pin Configuration

PIN DEFINITIONS

Pin No.	Name	Description
1	Anode	LED Anode
3	Cathode	LED Cathode
4	V_{SS}	Negative Supply Voltage
5	V_O	Output Voltage
6	V_{DD}	Positive Supply Voltage

SAFETY AND INSULATION RATINGS (As per DIN EN/IEC60747-5-5, this optocoupler is suitable for "safe electrical insulation" only within the safety limit data. Compliance with the safety ratings shall be ensured by means of protective circuits.)

Symbol	Parameter	Min.	Typ.	Max.	Unit
	Installation Classifications per DIN VDE 0110/1.89 Table 1				
	For Rated Mains Voltage < 150 V_{RMS}	–	I–IV	–	
	For Rated Mains Voltage < 300 V_{RMS}	–	I–IV	–	
	For Rated Mains Voltage < 450 V_{RMS}	–	I–III	–	
	For Rated Mains Voltage < 600 V_{RMS}	–	I–III	–	
	Climatic Classification	–	40/100/21	–	
	Pollution Degree (DIN VDE 0110/1.89)	–	2	–	
CTI	Comparative Tracking Index	175	–	–	
V_{PR}	Input-to-Output Test Voltage, Method b, $V_{IORM} \times 1.875 = V_{PR}$, 100% Production Test with $t_m = 1$ s, Partial Discharge < 5 pC	2651	–	–	
	Input-to-Output Test Voltage, Method a, $V_{IORM} \times 1.6 = V_{PR}$, Type and Sample Test with $t_m = 10$ s, Partial Discharge < 5 pC	2262	–	–	
V_{IORM}	Maximum Working Insulation Voltage	1414	–	–	V_{peak}
V_{IOTM}	Highest Allowable Over Voltage	8000	–	–	V_{peak}
	External Creepage	8.0	–	–	mm
	External Clearance	8.0	–	–	mm
	Insulation Thickness	0.5	–	–	mm
T_S	Safety Limit Values – Maximum Values Allowed in the Event of a Failure Case Temperature	150	–	–	$^{\circ}C$
$I_{S,INPUT}$	Input Current	200	–	–	mA
$P_{S,OUTPUT}$	Output Power	600	–	–	mW
R_{IO}	Insulation Resistance at T_S , $V_{IO} = 500$ V	10^9	–	–	Ω

FOD8384

ABSOLUTE MAXIMUM RATINGS (T_A = 25°C unless otherwise specified.)

Symbol	Parameter	Value	Unit
T _{STG}	Storage Temperature	-40 to +125	°C
T _{OPR}	Operating Temperature	-40 to +100	°C
T _J	Junction Temperature	-40 to +125	°C
T _{SOL}	Lead Solder Temperature <i>Refer to Reflow Temperature Profile on page 13.</i>	260 for 10 s	°C
I _{F(AVG)}	Average Input Current	25	mA
V _R	Reverse Input Voltage	5.0	V
I _{O(PEAK)}	Peak Output Current (Note 1)	3.0	A
V _{DD} - V _{SS}	Supply Voltage	-0.5 to 35	V
V _{O(PEAK)}	Peak Output Voltage	0 to V _{DD}	V
PD _I	Input Power Dissipation (Note 2, 4)	45	mW
PD _O	Output Power Dissipation (Note 3, 4)	500	mW

Stresses exceeding those listed in the Maximum Ratings table may damage the device. If any of these limits are exceeded, device functionality should not be assumed, damage may occur and reliability may be affected.

1. Maximum pulse width = 10 μs, maximum duty cycle = 0.2%.
2. No derating required across operating temperature range.
3. Derate linearly from 25°C at a rate of 5.2 mW/°C.
4. Functional operation under these conditions is not implied. Permanent damage may occur if the device is subjected to conditions outside these ratings.

RECOMMENDED OPERATING CONDITIONS

Symbol	Parameter	Min	Max	Unit
T _A	Ambient Operating Temperature	-40	100	°C
V _{DD} - V _{SS}	Supply Voltage	15	30	V
I _{F(ON)}	Input Current (ON)	10	16	mA
V _{F(OFF)}	Input Voltage (OFF)	0	0.8	V

Functional operation above the stresses listed in the Recommended Operating Ranges is not implied. Extended exposure to stresses beyond the Recommended Operating Ranges limits may affect device reliability.

ISOLATION CHARACTERISTICS (Apply over all recommended conditions; typical value is measured at T_A = 25°C.)

Symbol	Parameter	Conditions	Min	Typ	Max	Unit
V _{ISO}	Input-Output Isolation Voltage	T _A = 25°C, R.H. < 50%, t = 60 s, I _{I-O} ≤ 20 μA, 50 Hz (Note 5, 6)	5,000	-	-	V _{RMS}
R _{ISO}	Isolation Resistance	V _{I-O} = 500 V (Note 5)	-	10 ¹¹	-	Ω
C _{ISO}	Isolation Capacitance	V _{I-O} = 0 V, Frequency = 1.0 MHz (Note 6)	-	1	-	pF

5. Device is considered a two-terminal device: pins 1 and 3 are shorted together and pins 4, 5 and 6 are shorted together.
6. 5,000 VAC_{RMS} for 1 minute duration is equivalent to 6,000 VAC_{RMS} for 1 second duration.

FOD8384

ELECTRICAL CHARACTERISTICS (Apply over all recommended conditions, typical value is measured at $V_{DD} = 30\text{ V}$, $V_{SS} = \text{Ground}$, $T_A = 25^\circ\text{C}$ unless otherwise specified.)

Symbol	Parameter	Test Condition	Min	Typ	Max	Unit	Figure
V_F	Input Forward Voltage	$I_F = 10\text{ mA}$	1.10	1.43	1.80	V	17
$\Delta(V_F / T_A)$	Temperature Coefficient of Forward Voltage		-	-1.5	-	mV/°C	
BV_R	Input Reverse Breakdown Voltage	$I_R = 10\ \mu\text{A}$	5	-	-	V	
C_{IN}	Input Capacitance	$f = 1\text{ MHz}$, $V_F = 0\text{ V}$	-	60	-	pF	
I_{OH}	High Level Output Current (Note 1)	$V_{OH} = V_{DD} - 1\text{ V}$	-	-0.9	-0.5	A	2, 4
		$V_{OH} = V_{DD} - 6\text{ V}$	-	-	-2.5	A	2, 4, 20
I_{OL}	Low Level Output Current (Note 1)	$V_{OL} = V_{SS} + 1\text{ V}$	0.5	1.0	-	A	5, 7
		$V_{OL} = V_{SS} + 6\text{ V}$	2.5	-	-	A	5, 7, 219
V_{OH}	High Level Output Voltage (Note 7, 8)	$I_F = 10\text{ mA}$, $I_O = -2.5\text{ A}$	$V_{DD} - 7.0$	-	-	V	2
		$I_F = 10\text{ mA}$, $I_O = -100\text{ mA}$	$V_{DD} - 0.5$	-	-	V	4, 3, 21
V_{OL}	Low Level Output Voltage (Note 7, 8)	$I_F = 0\text{ mA}$, $I_O = 2.5\text{ A}$	-	-	$V_{SS} + 7.0$	V	5
		$I_F = 0\text{ mA}$, $I_O = 100\text{ mA}$	-	-	$V_{SS} + 0.5$	V	6, 22
I_{DDH}	High Level Supply Current	$V_O = \text{Open}$, $I_F = 7\text{ to }16\text{ mA}$	-	2.9	3.5	mA	8, 9, 23
I_{DDL}	Low Level Supply Current	$V_O = \text{Open}$, $V_F = 0\text{ to }0.8\text{ V}$	-	2.8	3.5	mA	8, 9, 24
I_{FLH}	Threshold Input Current Low-to-High	$I_O = 0\text{ mA}$, $V_O > 5\text{ V}$	-	3.1	7.5	mA	10, 16, 25
V_{FHL}	Threshold Input Voltage High-to-Low	$I_O = 0\text{ mA}$, $V_O < 5\text{ V}$	0.8	-	-	V	26
V_{UVLO+}	Under-Voltage Lockout Threshold	$I_F = 10\text{ mA}$, $V_O > 5\text{ V}$	11.5	13.0	14.5	V	18, 27
V_{UVLO-}		$I_F = 10\text{ mA}$, $V_O < 5\text{ V}$	10.0	11.5	13.0	V	18, 27
$UVLO_{HYS}$	Under-Voltage Lockout Threshold Hysteresis		-	1.5	-	V	

Product parametric performance is indicated in the Electrical Characteristics for the listed test conditions, unless otherwise noted. Product performance may not be indicated by the Electrical Characteristics if operated under different conditions.

7. In this test, V_{OH} is measured with a dc load current of 100 mA. When driving capacitive load V_{OH} will approach V_{DD} as I_{OH} approaches 0 A.
 8. Maximum pulse width = 1 ms, maximum duty cycle = 20%.

FOD8384

SWITCHING CHARACTERISTICS (Apply over all recommended conditions, typical value is measured at $V_{DD} = 30\text{ V}$, $V_{SS} = \text{Ground}$, $T_A = 25^\circ\text{C}$ unless otherwise specified.)

Symbol	Parameter	Test Condition	Min	Typ	Max	Unit	Figure
t_{PHL}	Propagation Delay Time to Logic LOW Output (Note 9)	$I_F = 7\text{ mA to }16\text{ mA}$, $R_g = 10\ \Omega$, $C_g = 10\text{ nF}$, $f = 250\text{ kHz}$, Duty Cycle = 50%	50	145	210	ns	11, 12, 13, 14, 15, 28
t_{PLH}	Propagation Delay Time to Logic HIGH Output (Note 10)		50	135	210	ns	11, 12, 13, 14, 15, 28
PWD	Pulse Width Distortion (Note 11) $ t_{PHL} - t_{PLH} $		–	25	65	ns	
PDD (Skew)	Propagation Delay Difference Between Any Two Parts (Note 12)		–90	–	90		
t_R	Output Rise Time (10% to 90%)		–	35	–	ns	28
t_F	Output Fall Time (90% to 10%)		–	25	–	ns	28
$t_{ULVO\ ON}$	ULVO Turn-On Delay		$I_F = 10\text{ mA}$, $V_O > 5\text{ V}$	–	1.7	–	μs
$t_{ULVO\ OFF}$	ULVO Turn-Off Delay	$I_F = 10\text{ mA}$, $V_O < 5\text{ V}$	–	0.1	–	μs	
$ CM_H $	Common Mode Transient Immunity at Output HIGH	$T_A = 25^\circ\text{C}$, $V_{DD} = 30\text{ V}$, $I_F = 10\text{ to }16\text{ mA}$, $V_{CM} = 1500\text{ V}$ (Note 13)	35	50	–	$\text{kV}/\mu\text{s}$	29
$ CM_L $	Common Mode Transient Immunity at Output LOW	$T_A = 25^\circ\text{C}$, $V_{DD} = 30\text{ V}$, $V_F = 0\text{ V}$, $V_{CM} = 1500\text{ V}$ (Note 14)	35	50	–	$\text{kV}/\mu\text{s}$	29

9. Propagation delay t_{PHL} is measured from the 50% level on the falling edge of the input pulse to the 50% level of the falling edge of the V_O signal.

10. Propagation delay t_{PLH} is measured from the 50% level on the rising edge of the input pulse to the 50% level of the rising edge of the V_O signal.

11. PWD is defined as $|t_{PHL} - t_{PLH}|$ for any given device.

12. The difference between t_{PHL} and t_{PLH} between any two FOD8384 parts under the same operating conditions, with equal loads.

13. Common mode transient immunity at output high is the maximum tolerable negative dV_{cm}/dt on the trailing edge of the common mode impulse signal, V_{CM} , to ensure that the output remains high (i.e., $V_O > 15.0\text{ V}$).

14. Common mode transient immunity at output low is the maximum tolerable positive dV_{cm}/dt on the leading edge of the common pulse signal, V_{CM} , to ensure that the output remains low (i.e., $V_O < 1.0\text{ V}$).

TYPICAL PERFORMANCE CHARACTERISTICS

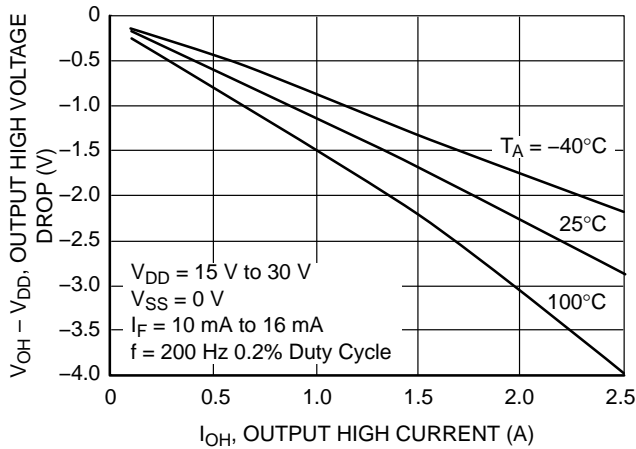

Figure 2. Output High Voltage Drop vs. Output High Current

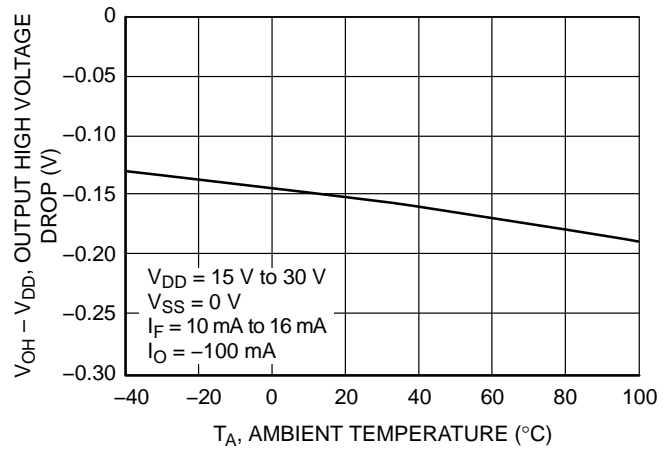

Figure 3. Output High Voltage Drop vs. Ambient Temperature

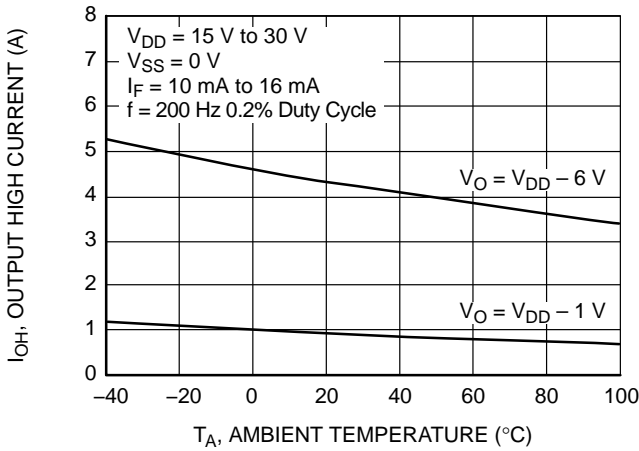

Figure 4. Output High Current vs. Ambient Temperature

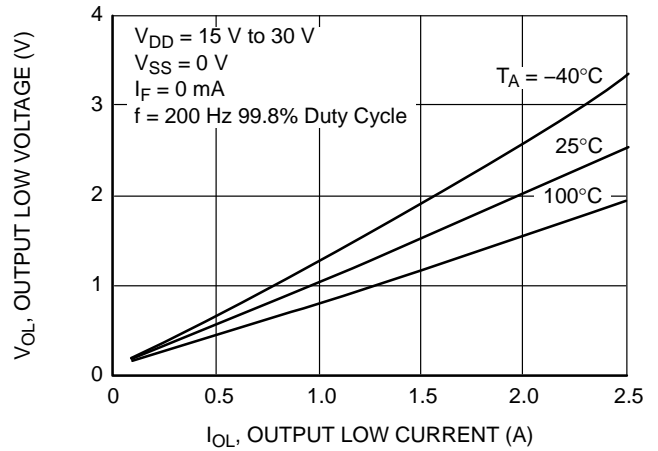

Figure 5. Output Low Voltage vs. Output Low Current

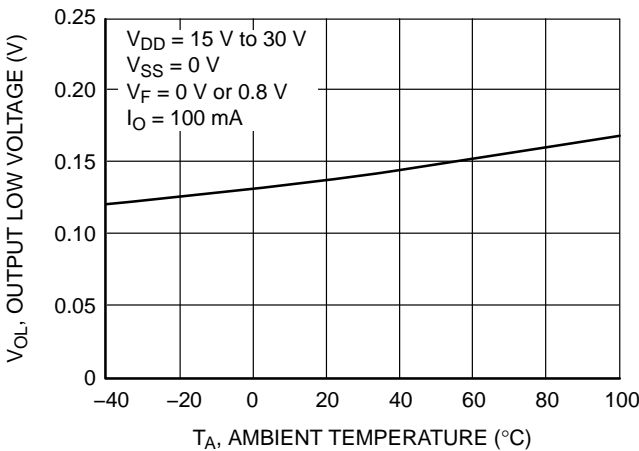

Figure 6. Output Low Voltage vs. Ambient Temperature

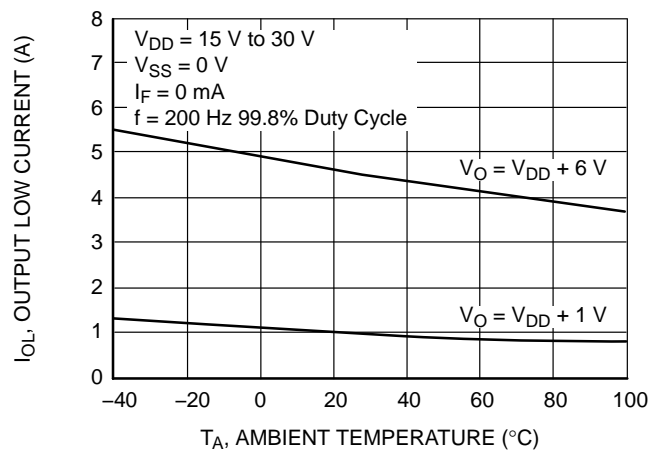

Figure 7. Output Low Current vs. Ambient Temperature

TYPICAL PERFORMANCE CHARACTERISTICS (CONTINUED)

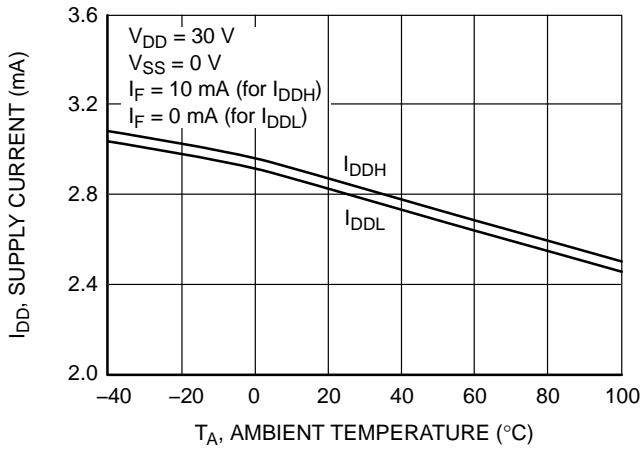

Figure 8. Supply Current vs. Ambient Temperature

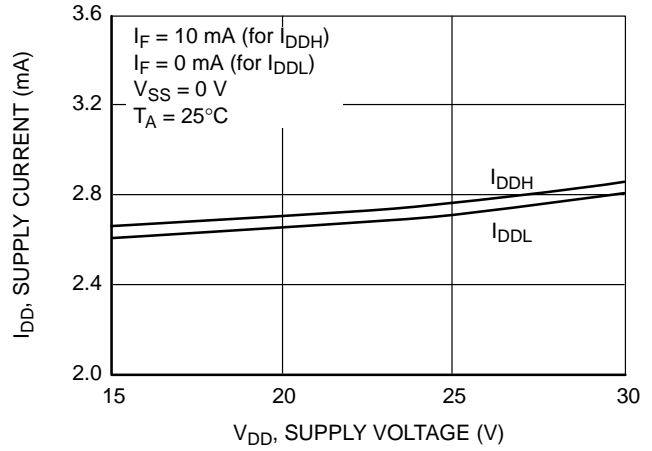

Figure 9. Supply Current vs. Supply Voltage

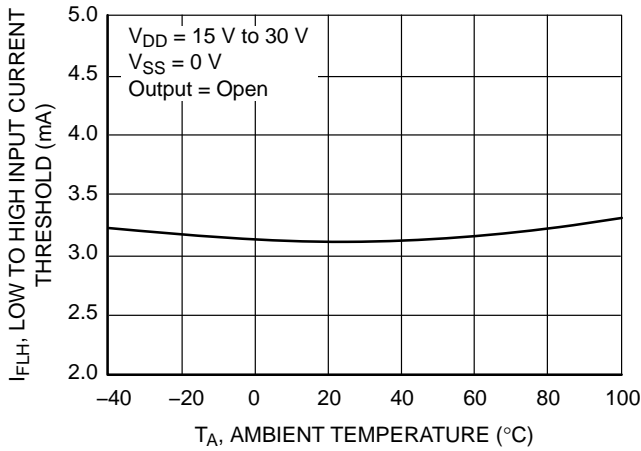

Figure 10. Low-to-High Input Current Threshold vs. Ambient Temperature

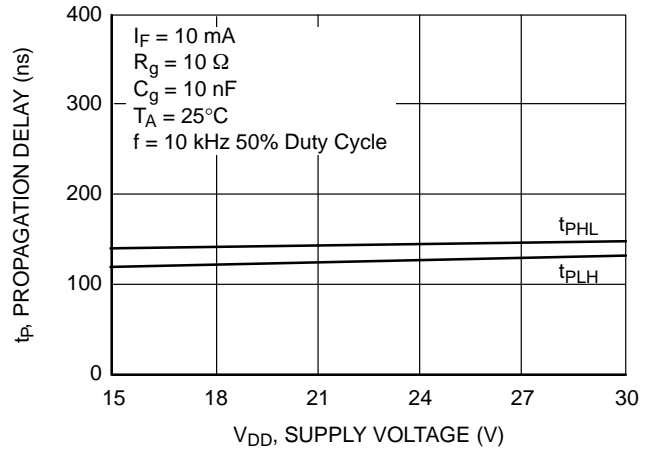

Figure 11. Propagation Delay vs. Supply Voltage

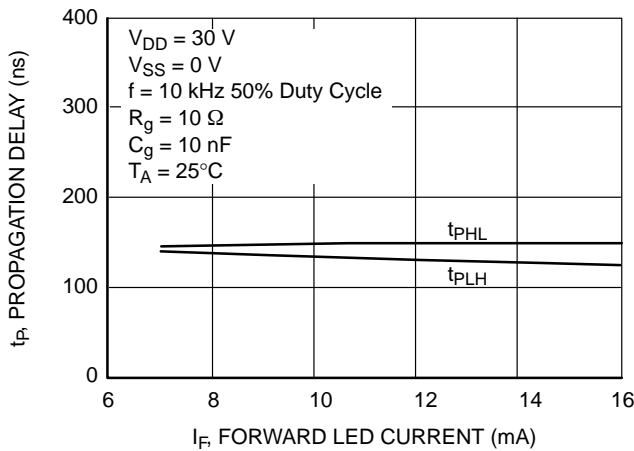

Figure 12. Propagation Delay vs. LED Forward Current

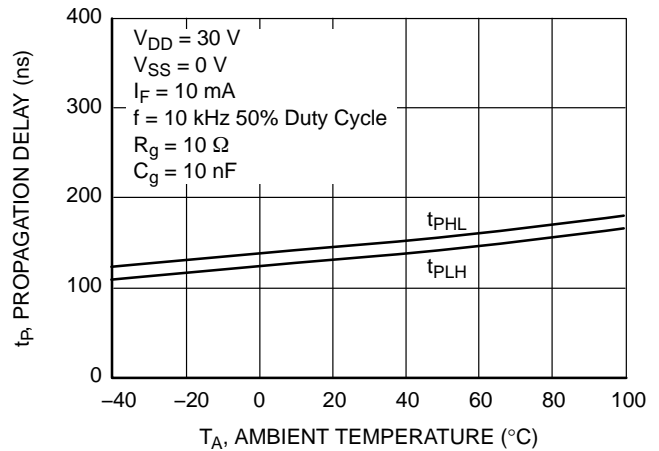

Figure 13. Propagation Delay vs. Ambient Temperature

TYPICAL PERFORMANCE CHARACTERISTICS (CONTINUED)

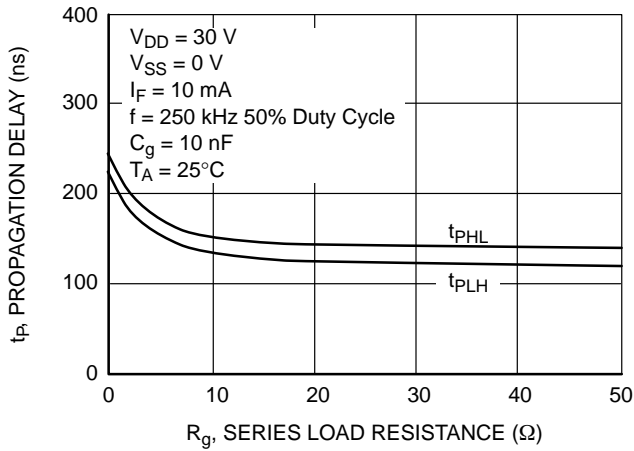

Figure 14. Propagation Delay vs. Series Load Resistance

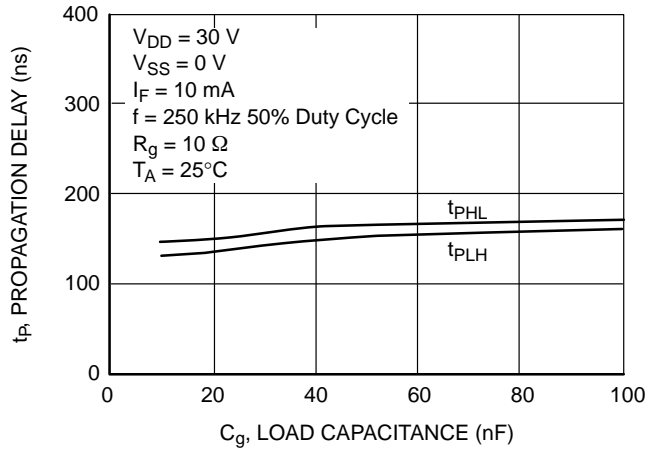

Figure 15. Propagation Delay vs. Load Capacitance

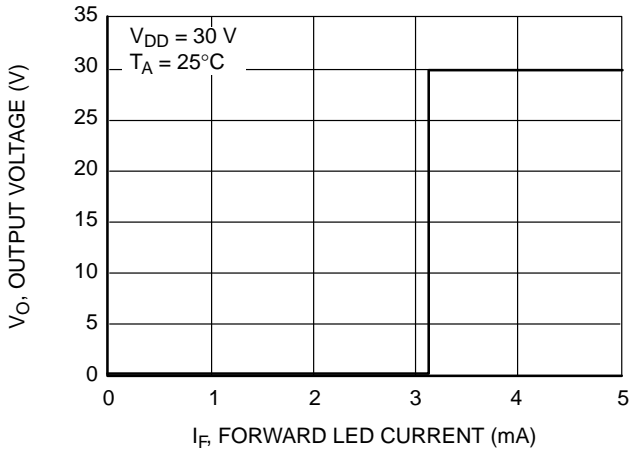

Figure 16. Transfer Characteristics

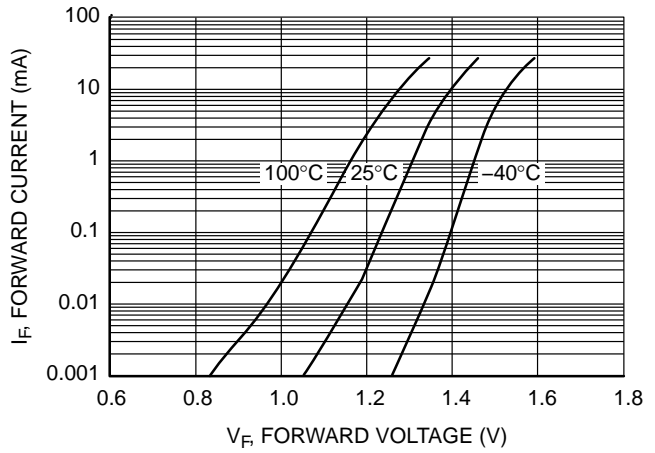

Figure 17. Input Forward Current vs. Forward Voltage

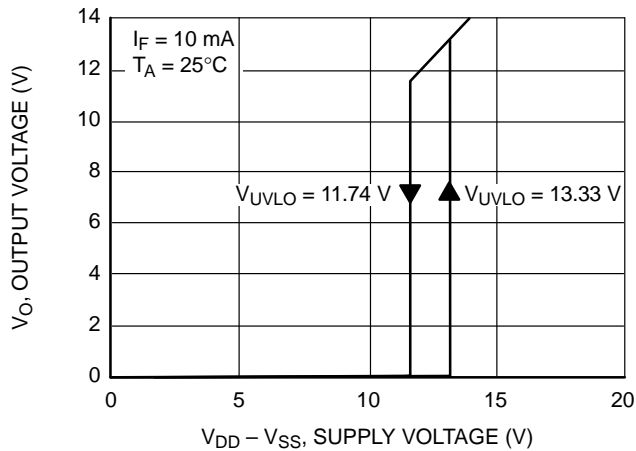
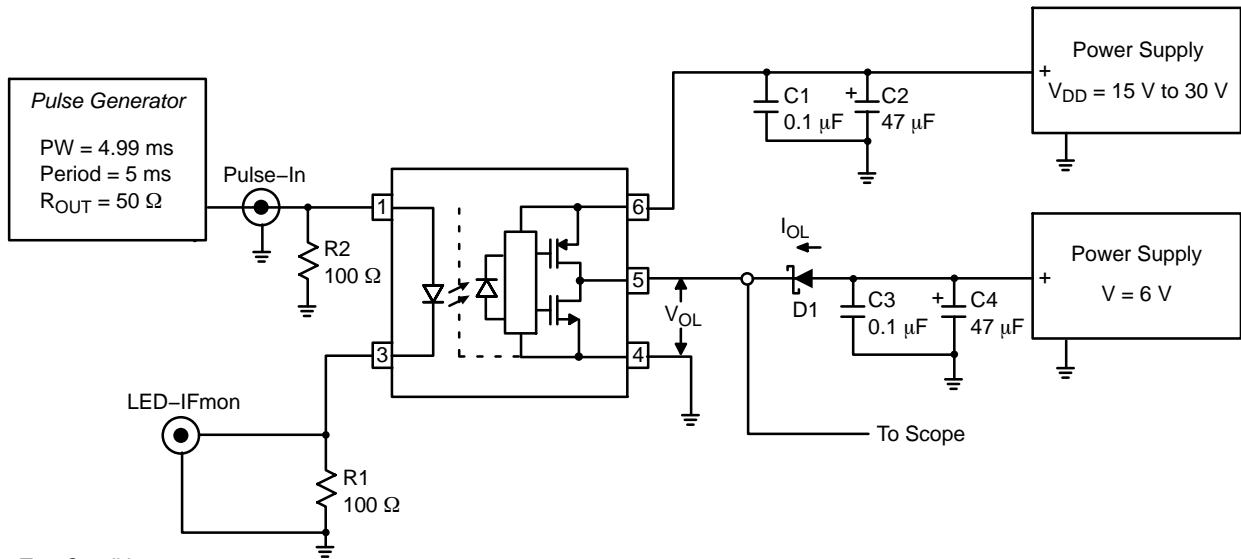

Figure 18. Under-Voltage Lockout

FOD8384

TEST CIRCUIT



Test Conditions:
 Frequency = 200 Hz
 Duty Cycle = 99.8%
 $V_{DD} = 15\text{ V to }30\text{ V}$
 $V_{SS} = 0\text{ V}$
 $I_F = 0\text{ mA}$

Figure 19. I_{OL} Test Circuit

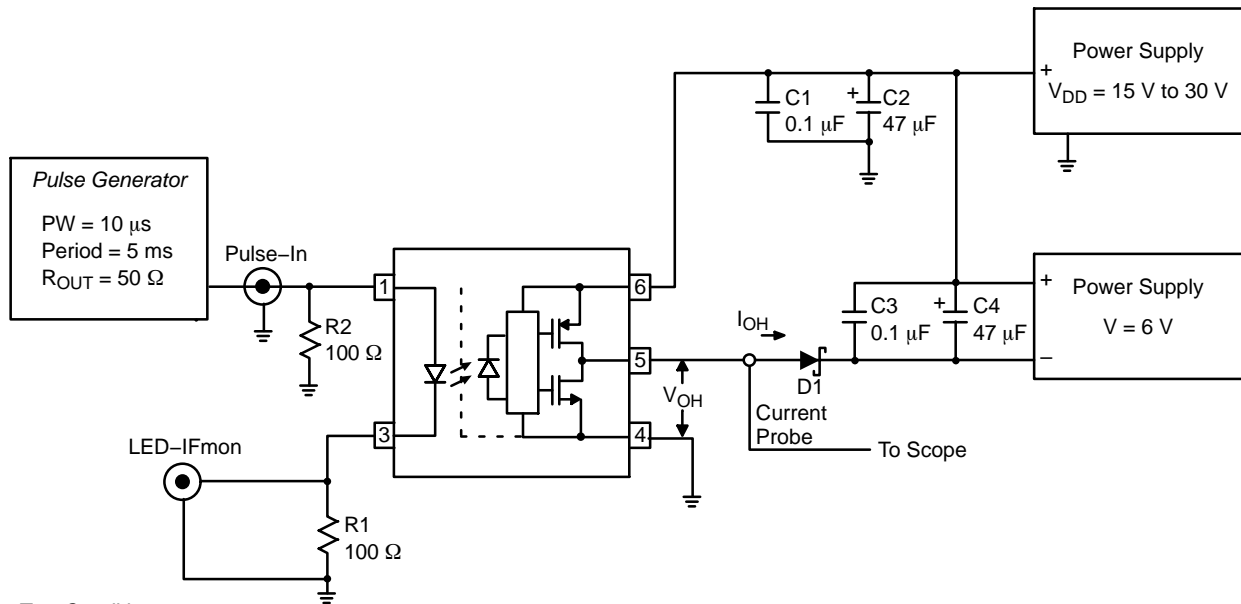

Test Conditions:
 Frequency = 200 Hz
 Duty Cycle = 0.2%
 $V_{DD} = 15\text{ V to }30\text{ V}$
 $V_{SS} = 0\text{ V}$
 $I_F = 10\text{ mA to }16\text{ mA}$

Figure 20. I_{OH} Test Circuit

FOD8384

TEST CIRCUIT (CONTINUED)

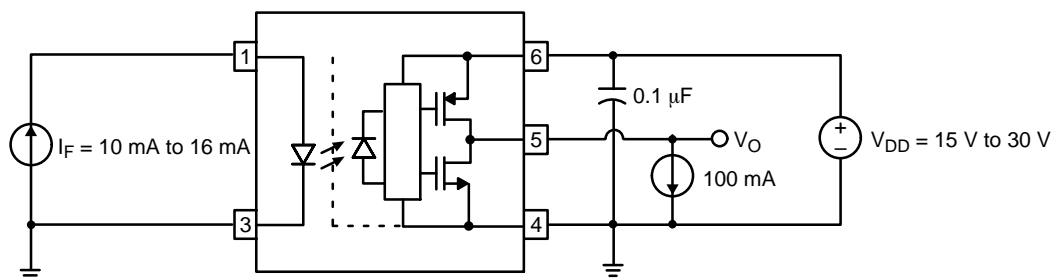

Figure 21. V_{OH} Test Circuit

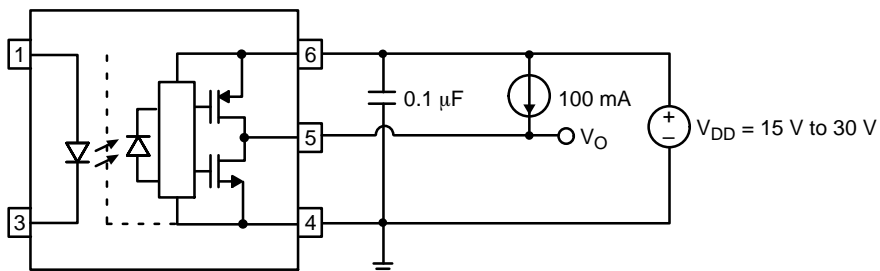

Figure 22. V_{OL} Test Circuit

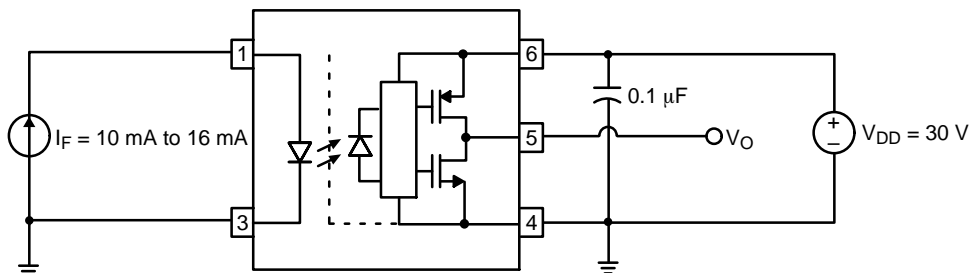

Figure 23. I_{DDH} Test Circuit

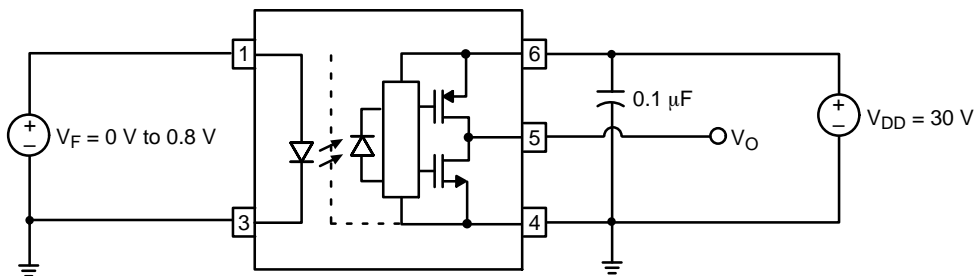

Figure 24. I_{DDL} Test Circuit

FOD8384

TEST CIRCUIT (CONTINUED)

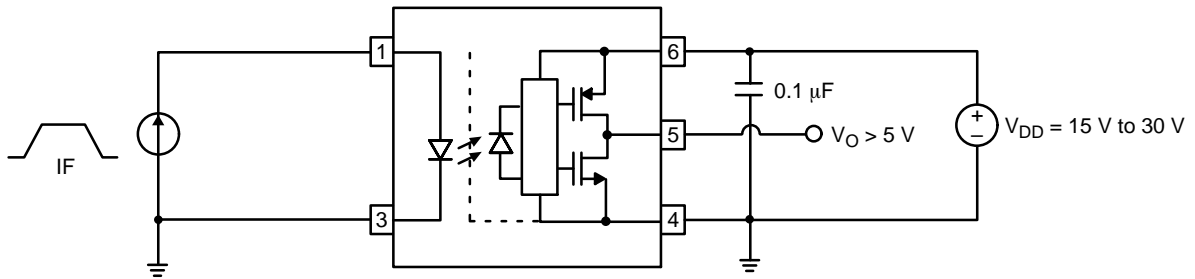

Figure 25. I_{FLH} Test Circuit

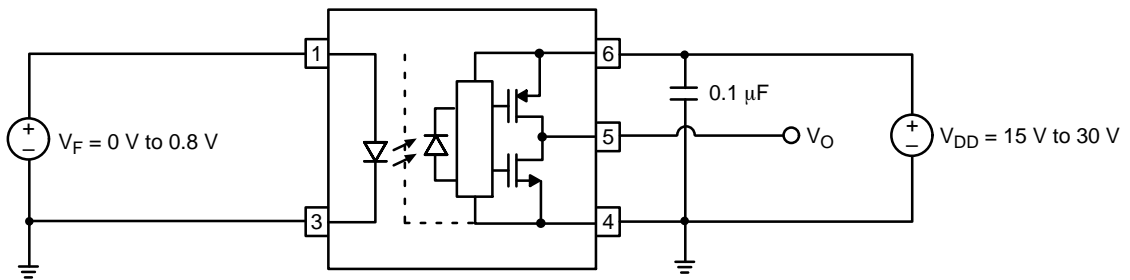

Figure 26. V_{FHL} Test Circuit

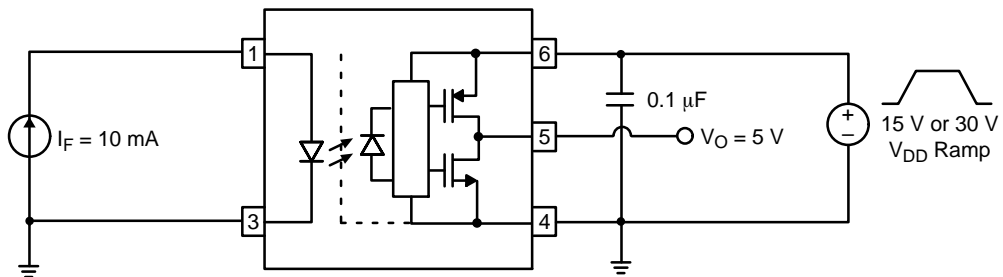

Figure 27. UVLO Test Circuit

FOD8384

TEST CIRCUIT (CONTINUED)

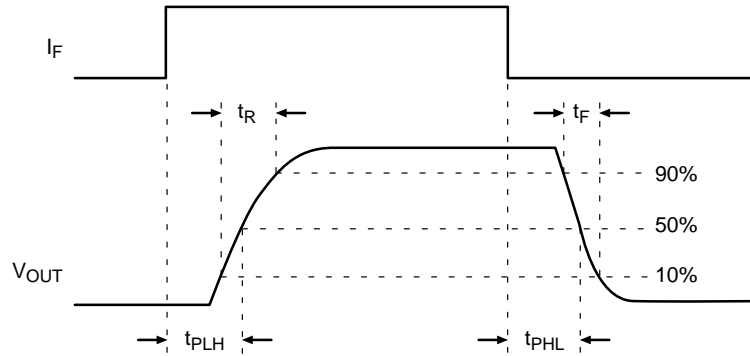
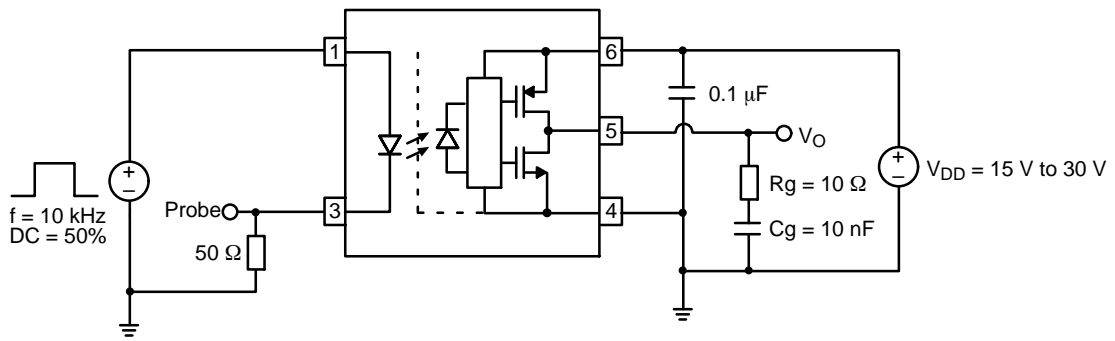

Figure 28. t_{PHL} , t_{PLH} , t_R , and t_F Test Circuit and Waveforms

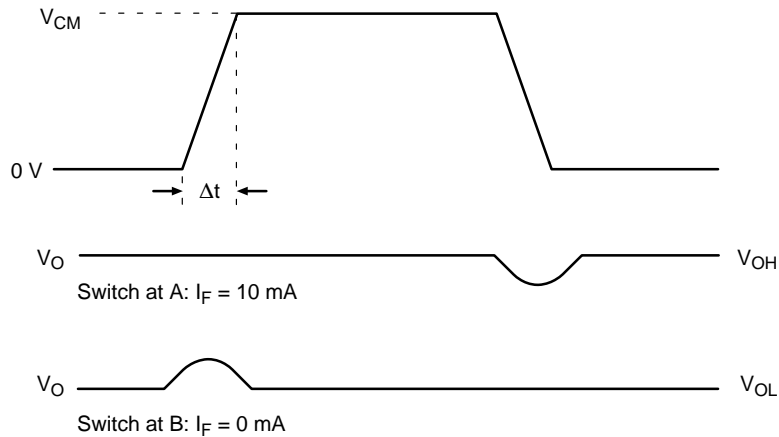
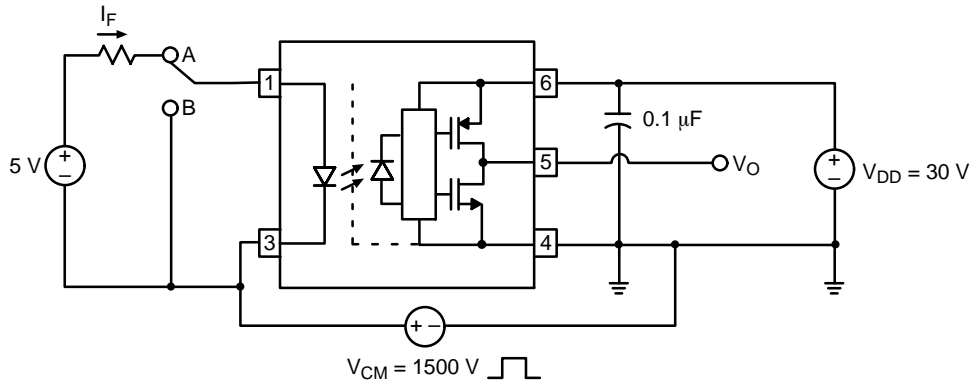

Figure 29. CMR Test Circuit and Waveforms

REFLOW PROFILE

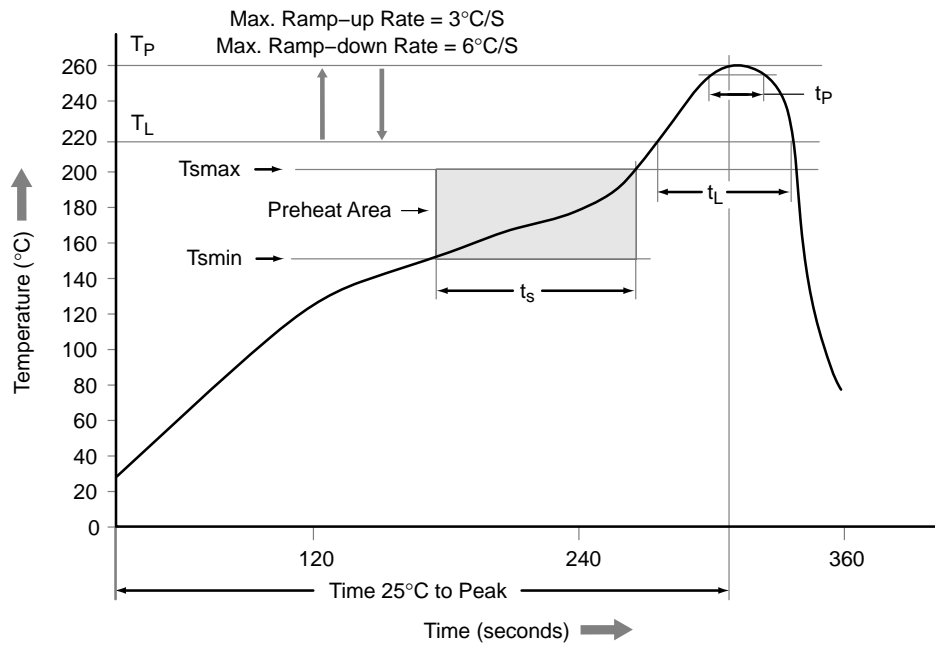

Figure 30. Reflow Profile

Profile Feature	Pb-Free Assembly Profile
Temperature Minimum (T_{smin})	150°C
Temperature Maximum (T_{smax})	200°C
Time (t_s) from (T_{smin} to T_{smax})	60 s to 120 s
Ramp-up Rate (t_L to t_p)	3°C/second maximum
Liquidous Temperature (T_L)	217°C
Time (t_L) Maintained Above (T_L)	60 s to 150 s
Peak Body Package Temperature	260°C +0°C / -5°C
Time (t_p) within 55°C of 260°C	30 s
Ramp-Down Rate (T_P to T_L)	6°C/s maximum
Time 25°C to Peak Temperature	8 minutes maximum

FOD8384

ORDERING INFORMATION

Part Number	Package	Shipping†
FOD8384	SOIC6 W LESS PIN 2, Wide Body SOP 5-Pin (Pb-Free)	100 Units / Tube
FOD8384R2	SOIC6 W LESS PIN 2, Wide Body SOP 5-Pin (Pb-Free)	1,000 Units / Tape & Reel
FOD8384V	SOIC6 W LESS PIN 2, Wide Body SOP 5-Pin, DIN EN/IEC60747-5-5 Option (Pb-Free)	100 Units / Tube
FOD8384R2V	SOIC6 W LESS PIN 2, Wide Body SOP 5-Pin, DIN EN/ IEC60747-5-5 Option (Pb-Free)	1,000 Units / Tape & Reel

†For information on tape and reel specifications, including part orientation and tape sizes, please refer to our Tape and Reel Packaging Specifications Brochure, BRD8011/D.

15. All packages are lead free per JEDEC: J-STD-020B standard.

OPTOPLANAR is registered trademark of Semiconductor Components Industries, LLC dba "onsemi" or its affiliates and/or subsidiaries in the United States and/or other countries.

MECHANICAL CASE OUTLINE PACKAGE DIMENSIONS

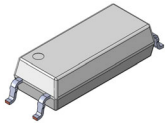

SOIC5 (6) 3.65x8.80x2.55, 1.27P
CASE 752AG
ISSUE B

DATE 24 JUL 2023

NOTES: UNLESS OTHERWISE SPECIFIED

- A) THIS PACKAGE DOES NOT CONFORM TO ANY STANDARD.
- B) ALL DIMENSIONS ARE IN MILLIMETERS.
- C) DIMENSIONS ARE EXCLUSIVE OF BURRS, MOLD FLASH AND TIE BAR PROTRUSIONS
- D) DRAWING CONFORMS TO ASME Y14.5M-1994

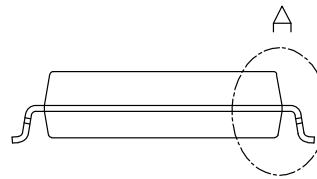
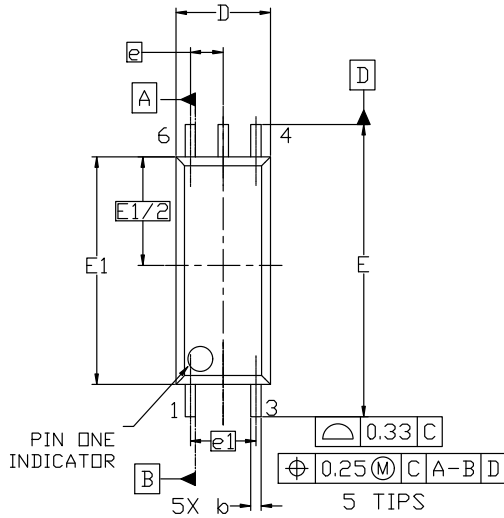

DIM	MILLIMETER		
	MIN.	NOM.	MAX.
A	--	--	2.95
A1	0.10	0.20	0.30
A2	2.45	2.55	2.65
b	0.31	0.41	0.51
c	0.19	0.22	0.25
D	3.55	3.65	3.75
E	11.20	11.30	11.40
E1	8.70	8.80	8.90
E1/2	4.20 BSC		
e	1.27 BSC		
e1	2.54 BSC		
L	0.44	0.59	0.74
L1	1.15	1.25	1.35
L2	0.25 BSC		
θ	0°	--	8°

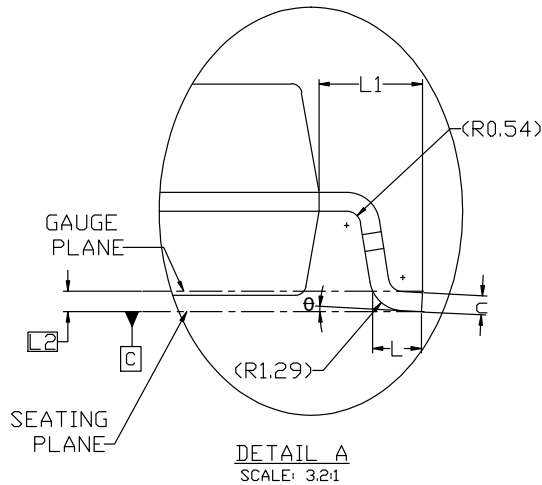
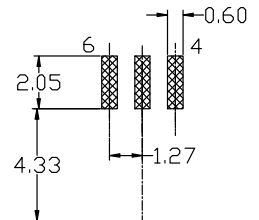
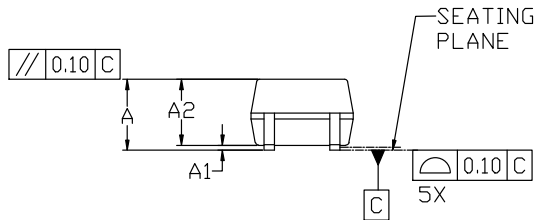

LAND PATTERN
RECOMMENDATION

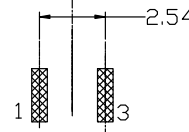

*FOR ADDITIONAL INFORMATION ON OUR PB-FREE STRATEGY AND SOLDERING DETAILS, PLEASE DOWNLOAD THE ON SEMICONDUCTOR SOLDERING AND MOUNTING TECHNIQUES REFERENCE MANUAL, SOLDERRM/D.

DOCUMENT NUMBER:	98AON13752G	Electronic versions are uncontrolled except when accessed directly from the Document Repository. Printed versions are uncontrolled except when stamped "CONTROLLED COPY" in red.
DESCRIPTION:	SOIC5 (6) 3.65x8.80x2.55, 1.27P	PAGE 1 OF 1

onsemi and ONSEMI are trademarks of Semiconductor Components Industries, LLC dba onsemi or its subsidiaries in the United States and/or other countries. onsemi reserves the right to make changes without further notice to any products herein. onsemi makes no warranty, representation or guarantee regarding the suitability of its products for any particular purpose, nor does onsemi assume any liability arising out of the application or use of any product or circuit, and specifically disclaims any and all liability, including without limitation special, consequential or incidental damages. onsemi does not convey any license under its patent rights nor the rights of others.

onsemi, **Onsemi**, and other names, marks, and brands are registered and/or common law trademarks of Semiconductor Components Industries, LLC dba "**onsemi**" or its affiliates and/or subsidiaries in the United States and/or other countries. **onsemi** owns the rights to a number of patents, trademarks, copyrights, trade secrets, and other intellectual property. A listing of **onsemi**'s product/patent coverage may be accessed at www.onsemi.com/site/pdf/Patent-Marking.pdf. **onsemi** reserves the right to make changes at any time to any products or information herein, without notice. The information herein is provided "as-is" and **onsemi** makes no warranty, representation or guarantee regarding the accuracy of the information, product features, availability, functionality, or suitability of its products for any particular purpose, nor does **onsemi** assume any liability arising out of the application or use of any product or circuit, and specifically disclaims any and all liability, including without limitation special, consequential or incidental damages. Buyer is responsible for its products and applications using **onsemi** products, including compliance with all laws, regulations and safety requirements or standards, regardless of any support or applications information provided by **onsemi**. "Typical" parameters which may be provided in **onsemi** data sheets and/or specifications can and do vary in different applications and actual performance may vary over time. All operating parameters, including "Typicals" must be validated for each customer application by customer's technical experts. **onsemi** does not convey any license under any of its intellectual property rights nor the rights of others. **onsemi** products are not designed, intended, or authorized for use as a critical component in life support systems or any FDA Class 3 medical devices or medical devices with a same or similar classification in a foreign jurisdiction or any devices intended for implantation in the human body. Should Buyer purchase or use **onsemi** products for any such unintended or unauthorized application, Buyer shall indemnify and hold **onsemi** and its officers, employees, subsidiaries, affiliates, and distributors harmless against all claims, costs, damages, and expenses, and reasonable attorney fees arising out of, directly or indirectly, any claim of personal injury or death associated with such unintended or unauthorized use, even if such claim alleges that **onsemi** was negligent regarding the design or manufacture of the part. **onsemi** is an Equal Opportunity/Affirmative Action Employer. This literature is subject to all applicable copyright laws and is not for resale in any manner.

ADDITIONAL INFORMATION

TECHNICAL PUBLICATIONS:

Technical Library: www.onsemi.com/design/resources/technical-documentation
onsemi Website: www.onsemi.com

ONLINE SUPPORT: www.onsemi.com/support

For additional information, please contact your local Sales Representative at www.onsemi.com/support/sales

