

# Green Mode Power Switch

## FSL137H

### Description

The highly integrated FSL137H consists of an integrated current mode Pulse Width Modulator (PWM) and an avalanche-rugged 700 V SENSEFET<sup>®</sup>. It is specifically designed for high-performance offline Switch Mode Power Supplies (SMPS) with minimal external components.

The integrated PWM controller features include a proprietary green-mode function that provides off-time modulation to linearly decrease the switching frequency at light-load conditions to minimize standby power consumption. To avoid acoustic noise problems, the minimum PWM frequency is set above 18 kHz. The green-mode function enables the power supply to meet international power conservation requirements. With the internal high-voltage startup circuitry, the power loss due to bleeding resistors is also eliminated. To further reduce power consumption, the PWM controller is manufactured using the BiCMOS process, which allows an operating current of only 3.5 mA.

The FSL137H built-in synchronized slope compensation achieves stable peak-current-mode control. The proprietary external line compensation ensures constant output power limit over a wide AC input voltage range, from 90 V<sub>AC</sub> to 264 V<sub>AC</sub>.

The FSL137H provides many protection functions. In addition to cycle-by-cycle current limiting, the internal open-loop protection circuit ensures safety when an open-loop or output short-circuit failure occurs. PWM output is disabled until V<sub>DD</sub> drops below the UVLO lower limit, when the controller starts up again. As long as V<sub>DD</sub> exceeds ~28 V, the internal OVP circuit is triggered.

Compared to a discrete MOSFET and controller or RCC switching converter solution, the FSL137H reduces total component count, design size, and weight while increasing efficiency, productivity, and system reliability. These devices provide a basic platform well suited for design of cost-effective flyback converters.

### Features

- Built-in 5 ms Soft-Start Function
- Internal Avalanche Rugged 700 V SENSEFET
- Low Audio Noise
- High-Voltage Startup
- Fixed PWM Frequency at 100 kHz
- Linearly Decreasing PWM Frequency to 18 kHz
- Peak-Current-Mode Control
- Cycle-by-Cycle Current Limiting
- Leading-Edge Blanking (LEB)
- Synchronized Slope Compensation
- Internal Open-loop Protection (OLP)
- V<sub>DD</sub> Under-Voltage Lockout (UVLO)
- V<sub>DD</sub> Over-Voltage Protection (OVP)
- Constant Power Limit (Full AC Input Range)
- Internal OTP Sensor with Hysteresis



**ON Semiconductor<sup>®</sup>**

[www.onsemi.com](http://www.onsemi.com)

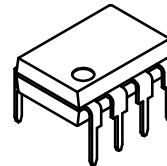

**PDIP8 9.59x6.6, 2.54P  
CASE 646CM**

### MARKING DIAGRAM

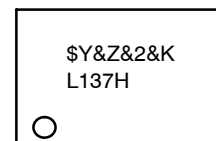

\$Y	= ON Semiconductor Logo
&Z	= Assembly Plant Code
&2	= 2-Digit Date code format
&K	= 2-Digits Lot Run Traceability Code
L137H	= Specific Device Code Data

### ORDERING INFORMATION

See detailed ordering and shipping information on page 2 of this data sheet.

### Applications

General-purpose switch-mode power supplies and flyback power converters, including:

- SMPS for VCR, STB, DVD & VCD Player, Printer, Facsimile, & Scanner
- Adapter for Camcorder

# FSL137H

**Table 1. ORDERING INFORMATION**

Part Number	Operating Temperature Range	SENSEFET	Package	Packing Method
FSL137HNY	-40°C to 105°C	3.0 A 700 V	8-Lead, Dual In-line Package (DIP)	Tube

## APPLICATION DIAGRAM

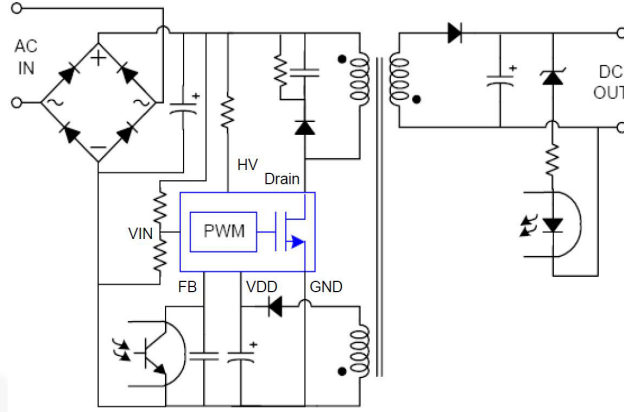

**Figure 1. Typical Flyback Application**

**Table 2. OUTPUT POWER TABLE (Note 1)**

Product	230 V <sub>AC</sub> ± 15% (Note 2)		85–265 V <sub>AC</sub>	
	Adapter (Note 3)	Open Frame (Note 4)	Adapter (Note 3)	Open Frame (Note 4)
FSL137H	17.5 W	25 W	13 W	19 W

1. The maximum output power can be limited by junction temperature.
2. 230 V<sub>AC</sub> or 100/115 V<sub>AC</sub> with doublers.
3. Typical continuous power in a non-ventilated enclosed adapter with sufficient drain pattern as a heat sink, at T<sub>A</sub> = 50°C ambient.
4. Maximum practical continuous power in an open-frame design with sufficient drain pattern as a heat sink, at T<sub>A</sub> = 50°C ambient.

## INTERNAL BLOCK DIAGRAM

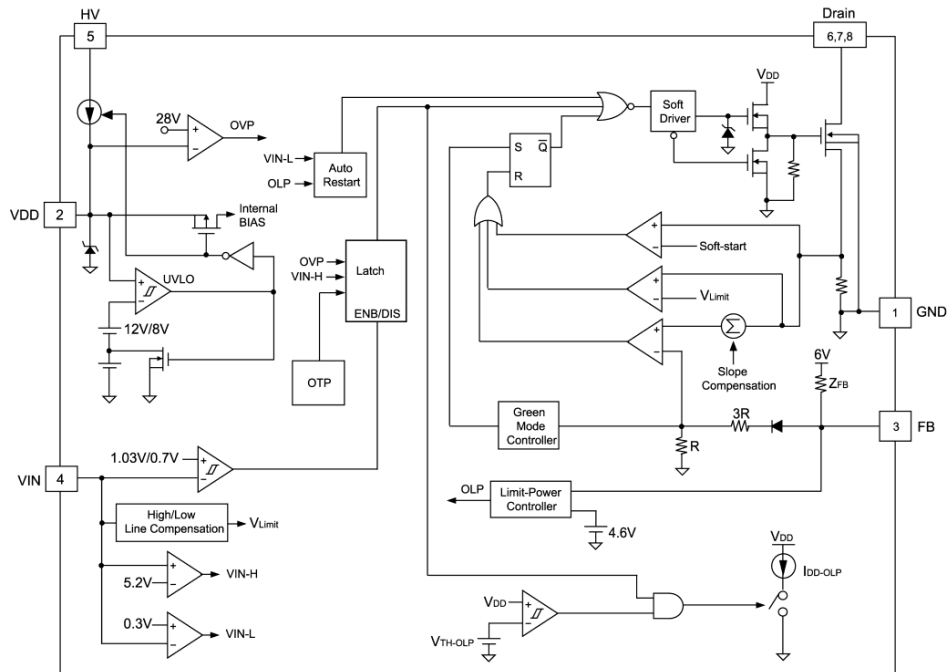

**Figure 2. Internal Block Diagram**

# FSL137H

## PIN CONFIGURATION

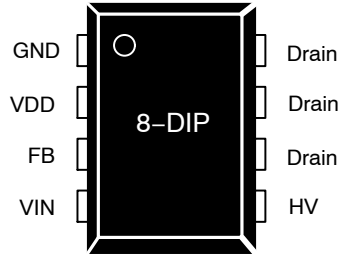

Figure 3. Pin Configuration

Table 3. PIN DEFINITIONS

Pin No.	Name	Description
1	GND	<b>Ground.</b> SENSEFET source terminal on primary side and internal controller ground.
2	VDD	<b>Power Supply.</b> The internal protection circuit disables PWM output as long as $V_{DD}$ exceeds the OVP trigger point.
3	FB	<b>Feedback.</b> The signal from the external compensation circuit is fed into this pin. The PWM duty cycle is determined in response to the signal on this pin and the internal current-sense signal.
4	VIN	<b>Line-Voltage Detection.</b> The line-voltage detection is used for brownout protection with hysteresis and constant output power limit over universal AC input range. This pin has additional protections that are pull-HIGH latch and pull-low auto recovery, depending on the application.
5	HV	<b>Startup.</b> For startup, this pin is pulled HIGH to the line input or bulk capacitor via resistors.
6, 7, 8	Drain	<b>SENSEFET Drain.</b> High-voltage power SENSEFET drain connection.

Table 4. ABSOLUTE MAXIMUM RATINGS

Symbol	Parameter	Min	Max	Unit
$V_{DRAIN}$	Drain Pin Voltage (Note 5, 6)		700	V
$I_{DM}$	Drain Current Pulsed (Note 7)		12	A
$E_{AS}$	Single Pulsed Avalanche Energy (Note 8)		230	mJ
$V_{VDD}$	DC Supply Voltage		30	V
$V_{FB}$	FB Pin Input Voltage	-0.3	7.0	V
$V_{VIN}$	VIN Pin Input Voltage	-0.3	7.0	V
$V_{HV}$	HV Pin Input Voltage		700	V
$P_D$	Power Dissipation ( $T_A < 50^\circ\text{C}$ )		1.5	W
$\theta_{JA}$	Junction-to-Air Thermal Resistance		80	$^\circ\text{C}/\text{W}$
$\Psi_{JT}$	Junction-to-Top Thermal Resistance (Note 9)		35	$^\circ\text{C}/\text{W}$
$T_J$	Operating Junction Temperature		+150	$^\circ\text{C}$
$T_{STG}$	Storage Temperature Range	-55	150	$^\circ\text{C}$
$T_L$	Lead Temperature (Wave Soldering or IR, 10 Seconds)		+260	$^\circ\text{C}$
ESD	Electrostatic Discharge Capability, All Pins Except HV Pin (Note 10)	Human Body Model: JESD22-A114	4.5	kV
		Charged Device Model: JESD22-C101	1.5	

Stresses exceeding those listed in the Maximum Ratings table may damage the device. If any of these limits are exceeded, device functionality should not be assumed, damage may occur and reliability may be affected.

5. All voltage values, except differential voltages, are given with respect to the network ground terminal.
6. Stresses beyond those listed under Absolute Maximum Ratings may cause permanent damage to the device.
7. Non-repetitive rating: Pulse width is limited by maximum junction temperature.
8.  $L = 51$  mH, starting  $T_J = 25^\circ\text{C}$ .
9. Measured on the package top surface.
10. All pins including HV pin: HBM = 1 kV, CDM = 1.25 kV

# FSL137H

**Table 5. RECOMMENDED OPERATING CONDITIONS**

Symbol	Parameter	Min	Max	Unit
T <sub>A</sub>	Operating Ambient Temperature	-40	+105	°C

Functional operation above the stresses listed in the Recommended Operating Ranges is not implied. Extended exposure to stresses beyond the Recommended Operating Ranges limits may affect device reliability.

**Table 6. ELECTRICAL CHARACTERISTICS** (V<sub>DD</sub> = 15 V, T<sub>A</sub> = 25°C unless otherwise noted)

Symbol	Parameter	Test Condition	Min	Typ	Max	Unit
--------	-----------	----------------	-----	-----	-----	------

**SENSEFET SECTION** (Note 11)

BV <sub>DSS</sub>	Drain-Source Breakdown Voltage	V <sub>GS</sub> = 0 V	700			V
I <sub>DSS</sub>	Zero-Gate-Voltage Drain Current	V <sub>DS</sub> = 700 V, V <sub>GS</sub> = 0 V		0.5	50.0	μA
		V <sub>DS</sub> = 560 V, V <sub>GS</sub> = 0 V, T <sub>A</sub> = 125°C		1	200	
R <sub>DS(ON)</sub>	Drain-Source On-State Resistance (Note 12)	V <sub>GS</sub> = 10 V, I <sub>D</sub> = 0.5 A		4.00	4.75	Ω
C <sub>ISS</sub>	Input Capacitance	V <sub>GS</sub> = 0 V, V <sub>DS</sub> = 25 V, f = 1MHz		315	410	pF
C <sub>OSS</sub>	Output Capacitance	V <sub>GS</sub> = 0 V, V <sub>DS</sub> = 25 V, f = 1MHz		47	61	pF
C <sub>RSS</sub>	Reverse Transfer Capacitance	V <sub>GS</sub> = 0 V, V <sub>DS</sub> = 25 V, f = 1MHz		9	14	pF
t <sub>d(on)</sub>	Turn-on Delay Time	V <sub>DS</sub> = 350 V, I <sub>D</sub> = 1.0 A		11.2	33.0	ns
t <sub>r</sub>	Rise Time	V <sub>DS</sub> = 350 V, I <sub>D</sub> = 1.0 A		34	78	ns
t <sub>d(off)</sub>	Turn-off Delay Time	V <sub>DS</sub> = 350 V, I <sub>D</sub> = 1.0 A		28.2	67.0	ns
t <sub>f</sub>	Fall Time	V <sub>DS</sub> = 350 V, I <sub>D</sub> = 1.0 A		32	74	ns

**V<sub>DD</sub> SECTION**

V <sub>OP</sub>	Continuously Operating Voltage				22	V
V <sub>DD-ON</sub>	Start Threshold Voltage		11	12	13	V
V <sub>DD-OFF</sub>	Minimum Operating Voltage		7	8	9	V
I <sub>DD-ST</sub>	Startup Current	V <sub>DD-ON</sub> - 0.16 V			30	μA
I <sub>DD-OP</sub>	Operating Supply Current	V <sub>DD</sub> = 15 V, V <sub>FB</sub> = 3 V	3.0	3.5	4.0	mA
I <sub>DD-BM</sub>	Green-Mode Operating Supply Current	V <sub>FB</sub> = V <sub>FB-G</sub>		2		mA
I <sub>DD-OLP</sub>	Internal Sink Current	V <sub>TH-OLP</sub> + 0.1 V	30	60	90	μA
V <sub>TH-OLP</sub>	I <sub>DD-OLP</sub> Off Voltage		5	6	7	V
V <sub>DD-OVP</sub>	V <sub>DD</sub> Over-Voltage Protection		27	28	29	V
t <sub>D-VDDOVP</sub>	V <sub>DD</sub> Over-Voltage Protection Debounce Time		75	130	200	μs

**HV SECTION**

I <sub>HV</sub>	Maximum Current Drawn from HV Pin	HV 120 V <sub>DC</sub> , V <sub>DD</sub> = 0 V with 10 μF	1.5	3.5	5.0	mA
I <sub>HV-LC</sub>	Leakage Current After Startup	HV 700 V, V <sub>DD</sub> = V <sub>DD-OFF</sub> + 1 V		1	20	μA

**OSCILLATOR SECTION**

f <sub>OSC</sub>	Frequency in Nominal Mode	Center Frequency	94	100	106	kHz
f <sub>OSC-G</sub>	Green-Mode Frequency		14	18	22	kHz
D <sub>MAX</sub>	Maximum Duty Cycle			85		%
f <sub>DV</sub>	Frequency Variation vs. V <sub>DD</sub> Deviation	V <sub>DD</sub> = 9 V to 22 V			5	%
f <sub>DT</sub>	Frequency Variation vs. Temperature Deviation (Note 11)	T <sub>A</sub> = -40 to +105°C			5	%

# FSL137H

**Table 6. ELECTRICAL CHARACTERISTICS** ( $V_{DD} = 15\text{ V}$ ,  $T_A = 25^\circ\text{C}$  unless otherwise noted) (continued)

Symbol	Parameter	Test Condition	Min	Typ	Max	Unit
<b>V<sub>IN</sub> SECTION</b>						
$V_{IN-ON}$	PWM Turn-on Threshold Voltage		0.98	1.03	1.08	V
$V_{IN-RL}$	Release Latch Voltage		0.65	0.70	0.75	V
$V_{IN-H}$	Pull HIGH Latch Trigger Level		4.9	5.2	5.5	V
$t_{IN-H}$	Pull HIGH Latch Debounce Time			100		$\mu\text{s}$
$V_{IN-L}$	Pull LOW Auto Recovery Trigger Level		0.2	0.3	0.4	V

## FEEDBACK INPUT SECTION

$A_V$	FB Voltage to Current-Sense Attenuation			1/4		V/V
$Z_{FB}$	Input Impedance			9.5		$\text{k}\Omega$
$V_{FB-OPEN}$	Output High Voltage		5			V
$V_{FB-OLP}$	FB Open-Loop Trigger Level		4.4	4.6	4.8	V
$t_{D-OLP}$	Delay Time of FB Pin Open-loop Protection		50	56	59	ms
$V_{FB-N}$	Green-Mode Entry FB Voltage		2.3	2.5	2.7	V
$V_{FB-G}$	Green-Mode Ending FB Voltage			$V_{FB-N} - 0.1$		V
$V_{FB-ZDC}$	Zero Duty Cycle FB Voltage		1.9	2.1	2.3	V

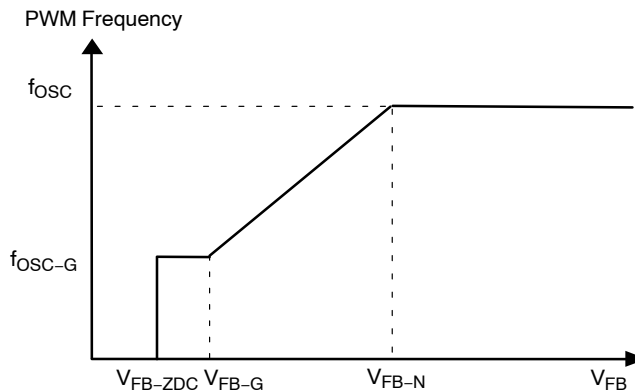

**Figure 4.  $V_{FB}$  vs. PWM Frequency**

Symbol	Parameter	Test Condition	Min	Typ	Max	Unit
<b>CURRENT-SENSE SECTION</b>						
$I_{LIM}$ at $V_{IN} = 1.2\text{ V}$	Peak Current Limit	$V_{IN} = 1.2\text{ V}$	0.74	0.84	0.94	A
$I_{LIM}$ at $V_{IN} = 3.6\text{ V}$	Peak Current Limit	$V_{IN} = 3.6\text{ V}$	0.64	0.74	0.84	A
$t_{SS}$	Period during Soft Startup Time (Note 11)		4.5	5.0	5.5	ms

## OVER-TEMPERATURE PROTECTION SECTION (OTP)

$T_{OTP}$	Protection Junction Temperature (Notes 11, 13)			142		$^\circ\text{C}$
-----------	--	--	--	-----	--	------------------

11. These parameters, although guaranteed, are not 100% tested in production.

12. Pulse test: pulse width  $\leq 300\ \mu\text{s}$ , duty  $\leq 2\%$ .

13. When activated, the output is disabled and the latch is turned off.

TYPICAL CHARACTERISTICS

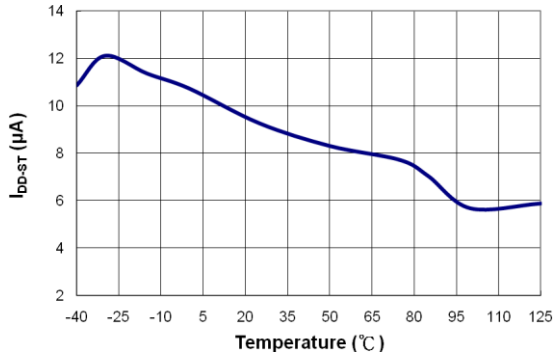

Figure 5. I<sub>DD-ST</sub> vs. Temperature

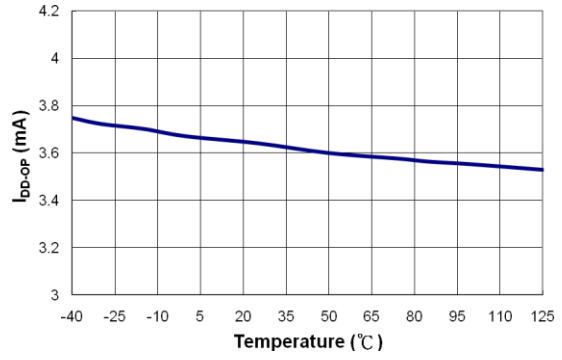

Figure 6. I<sub>DD-OP</sub> vs. Temperature

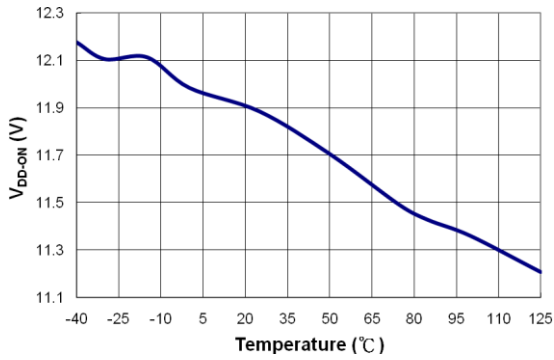

Figure 7. V<sub>DD-ON</sub> vs. Temperature

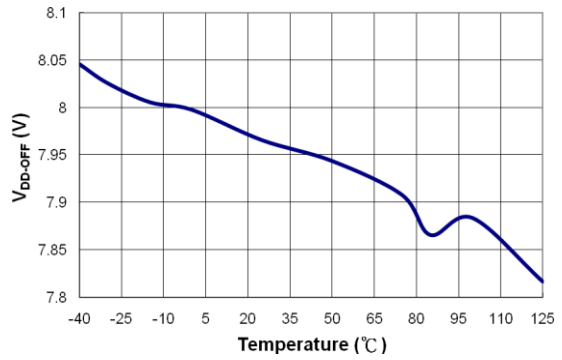

Figure 8. V<sub>DD-OFF</sub> vs. Temperature

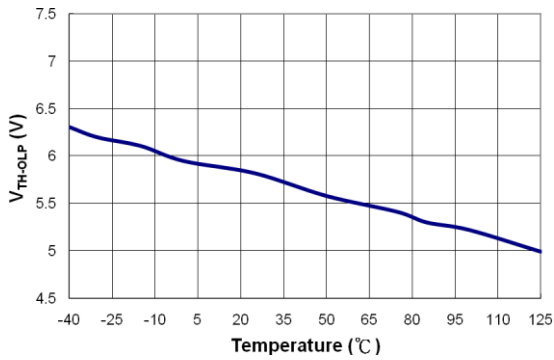

Figure 9. V<sub>TH-OLP</sub> vs. Temperature

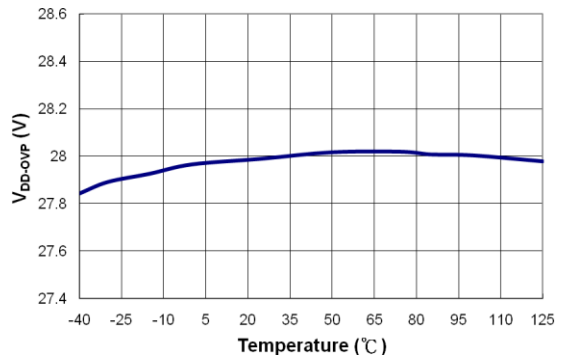

Figure 10. V<sub>DD-OVP</sub> vs. Temperature

TYPICAL CHARACTERISTICS (continued)

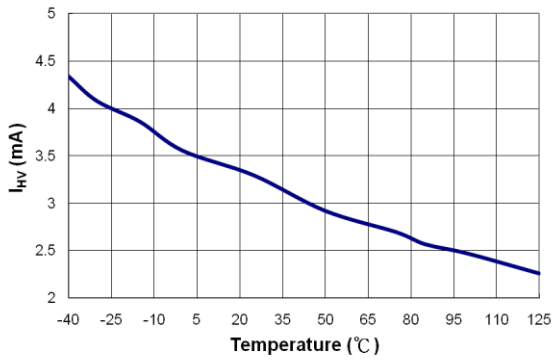

Figure 11. I<sub>HV</sub> vs. Temperature

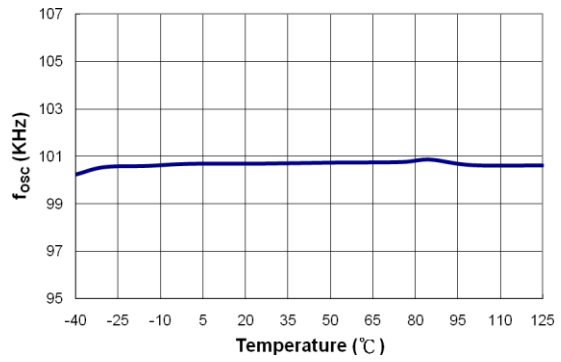

Figure 12. f<sub>osc</sub> vs. Temperature

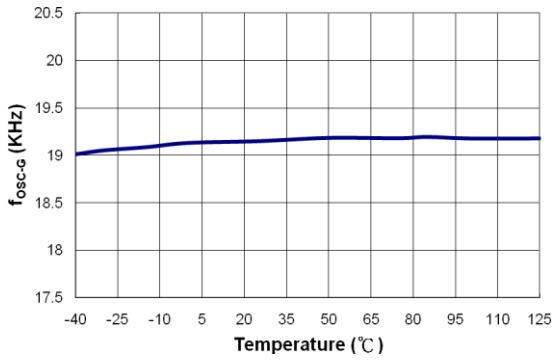

Figure 13. f<sub>osc-G</sub> vs. Temperature

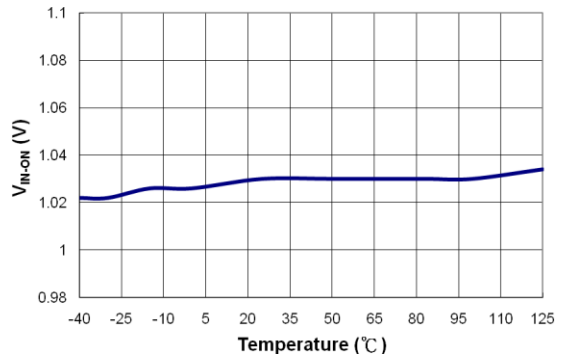

Figure 14. V<sub>IN-ON</sub> vs. Temperature

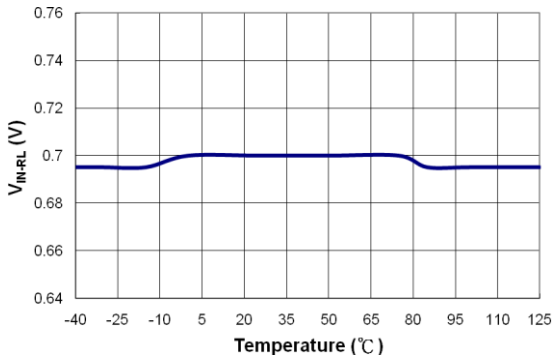

Figure 15. V<sub>IN-RL</sub> vs. Temperature

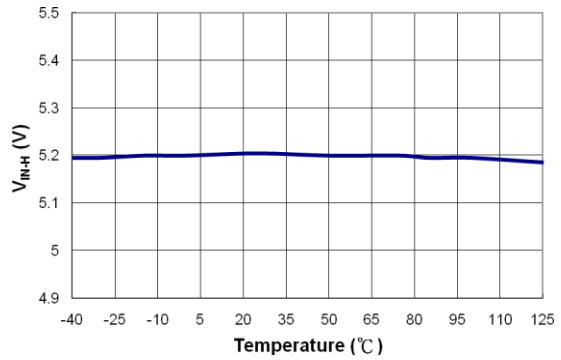

Figure 16. V<sub>IN-H</sub> vs. Temperature

TYPICAL CHARACTERISTICS (continued)

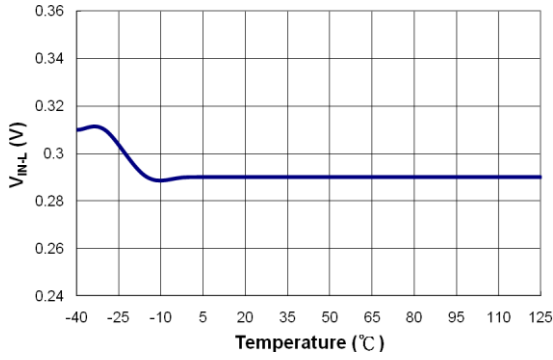

Figure 17. V<sub>IN-L</sub> vs. Temperature

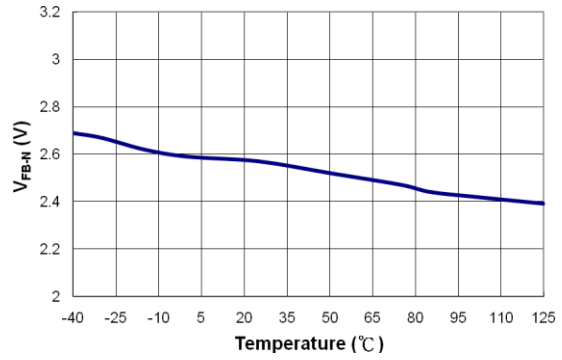

Figure 18. V<sub>FB-N</sub> vs. Temperature

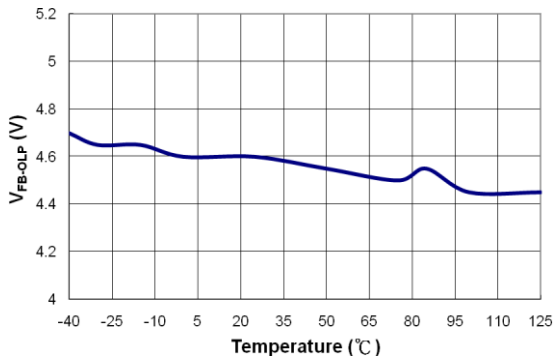

Figure 19. V<sub>FB-OLP</sub> vs. Temperature

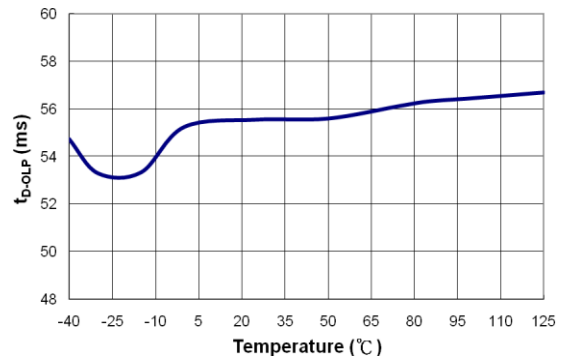

Figure 20. t<sub>D-OLP</sub> vs. Temperature

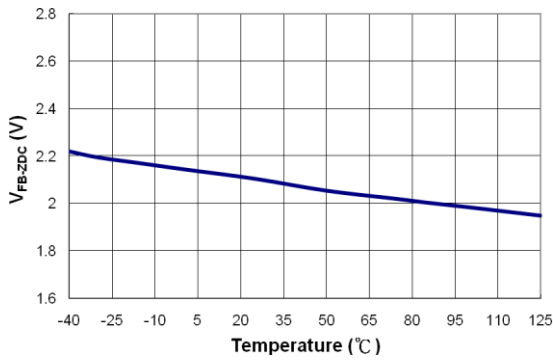

Figure 21. V<sub>FB-ZDC</sub> vs. Temperature

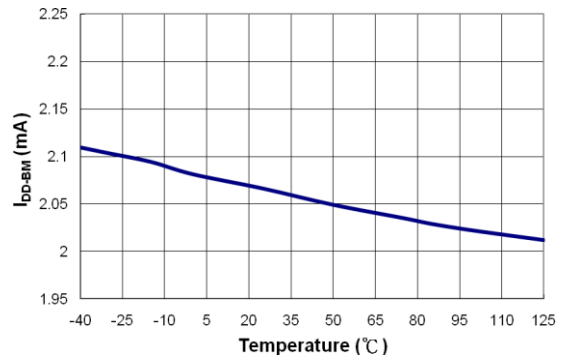

Figure 22. I<sub>DD-BM</sub> vs. Temperature



**FUNCTIONAL DESCRIPTION**

**Startup Operation**

For startup, the HV pin is connected to the line input or bulk capacitor through the external resistor,  $R_{HV}$ , as shown in Figure 23. Typical startup current drawn from the HV pin is 3.5 mA and it charges the  $V_{DD}$  capacitor through the resistor  $R_{HV}$ . The startup current turns off when the  $V_{DD}$  capacitor voltage reaches  $V_{DD-ON}$ . The  $V_{DD}$  capacitor maintains  $V_{DD}$  until the auxiliary winding of the transformer provides the operating current.

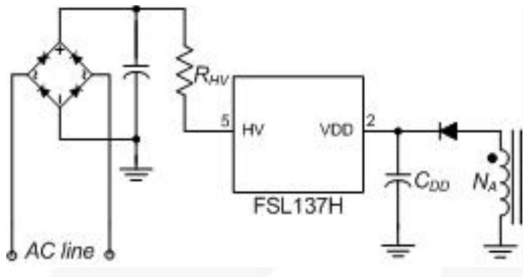

**Figure 23. Startup Circuit**

**Slope Compensation**

FSL137H is designed for flyback power converters. The peak-current-mode control is used to optimize system performance. Slope compensation is added to stabilize current loop. FSL137H inserts a synchronized, positively sloped ramp at each switching cycle.

**Soft-Start**

The FSL137H has internal soft-start circuit that slowly increases the SENSEFET current after startup. The typical soft-start time is 5 ms during which the  $V_{Limit}$  level is increased in six steps to smoothly establish the required output voltage, as shown in Figure 24. It also helps to prevent transformer saturation and reduce the stress on the secondary diode during startup.

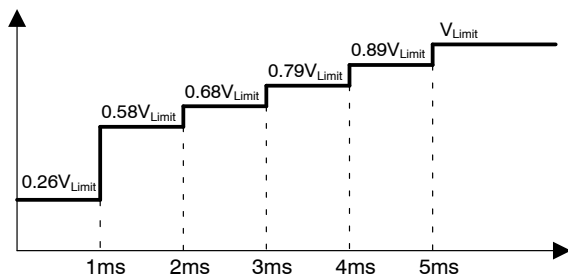
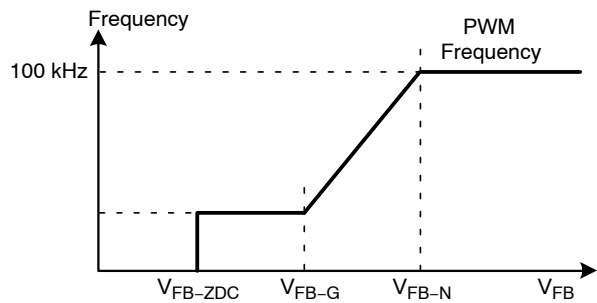

**Figure 24. Soft-Start Function**

**Green-Mode Operation**

The FSL137H uses feedback voltage ( $V_{FB}$ ) as an indicator of the output load and modulates the PWM

frequency, as shown in Figure 25, such that the switching frequency decreases as load decreases. In heavy load conditions, the switching frequency is 100 kHz. Once  $V_{FB}$  decreases below  $V_{FB-N}$  (2.5 V), the PWM frequency starts to linearly decrease from 100 kHz to 18 kHz to reduce the switching losses. As  $V_{FB}$  decreases below  $V_{FB-G}$  (2.4 V), the switching frequency is fixed at 18 kHz and FSL137H enters into “deep” green mode to reduce the standby power consumption. As  $V_{FB}$  decreases below  $V_{FB-ZDC}$  (2.1 V), FSL137H enters into burst-mode operation. When  $V_{FB}$  drops below  $V_{FB-ZDC}$ , FSL137H stops switching and the output voltage starts to drop, which causes the feedback voltage to rise. Once  $V_{FB}$  rises above  $V_{FB-ZDC}$ , switching resumes. Burst mode alternately enables and disables switching, thereby reducing switching loss to improve power saving, as shown in Figure 26.



**Figure 25. PWM Frequency**

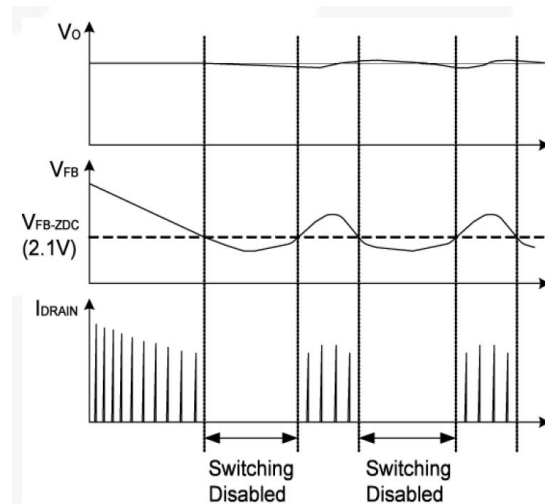

**Figure 26. Burst Mode Operation**

**Constant Power Control**

To limit the output power of the converter constantly, high/low line compensation is included. Sensing the converter input voltage through the VIN pin, the high/low line compensation function generates a relative

peak-current-limit threshold voltage for constant power control, as shown in Figure 27.

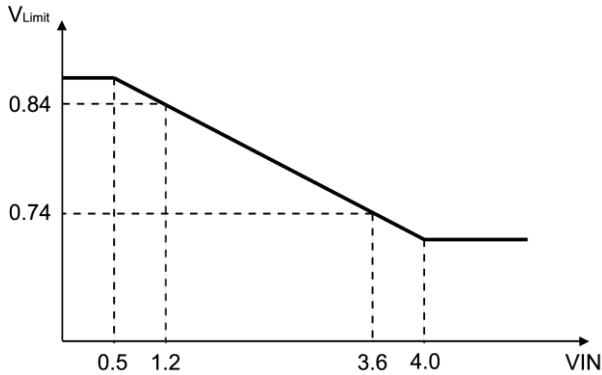

Figure 27. Constant Power Control

**Protections**

The FSL137H provides full protection functions to prevent the power supply and the load from being damaged. The protection features include:

*Latch/Auto Recovery Function*

The FSL137H provides additional protections by the VIN pin, such as pull-HIGH latch and pull-LOW auto recovery that depend on the application. As shown in Figure 28, when V<sub>IN</sub> is higher than 5.2 V, FSL137H is latched until the V<sub>DD</sub> is discharged. FSL137H is in auto recovery when V<sub>IN</sub> is lower than 0.3 V.

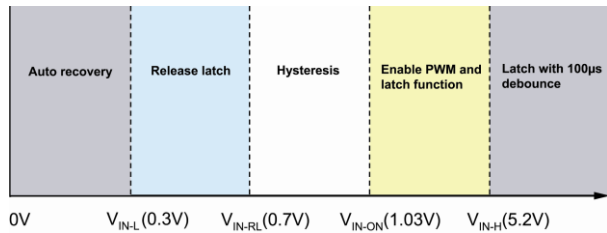

Figure 28. VIN Pin Function

*Open-Loop/Overload Protection (OLP)*

When the upper branch of the voltage divider for the shunt regulator (KA431 shown) is broken, as shown in Figure 29,

or over current or output short occurs. There is no current flowing through the opto-coupler transistor, which pulls up the feedback voltage to 6 V. When the feedback voltage is above 4.6 V for longer than 56 ms, OLP is triggered. This protection is also triggered when the SMPS output drops below the nominal value longer than 56 ms due to the overload condition.

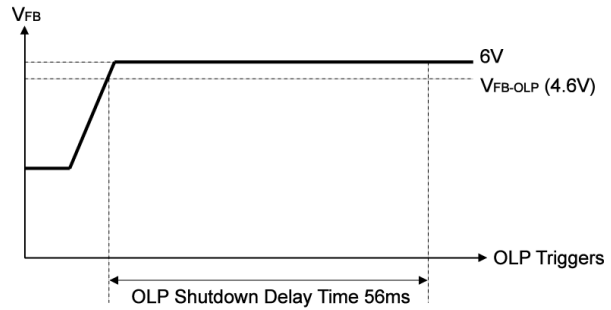
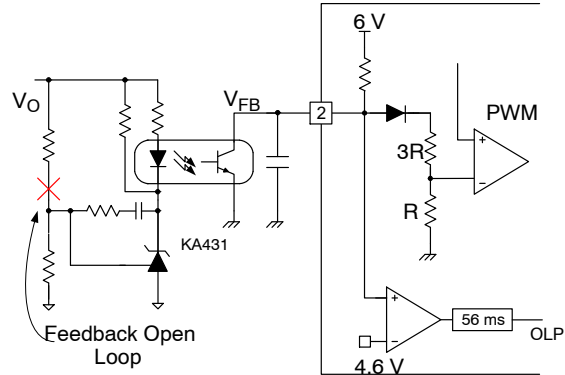

Figure 29. OLP Operation

*VDD Over-Voltage Protection (OVP)*

V<sub>DD</sub> over-voltage protection prevents IC damage caused by over voltage on the V<sub>DD</sub> pin. The OVP is triggered when V<sub>DD</sub> reaches 28 V. It has a debounce time (typically 130 µs) to prevent false trigger by switching noise.

*Over-Temperature Protection (OTP)*

The SENSEFET and the control IC are integrated, making it easier to detect the temperature of the SENSEFET. When the temperature exceeds approximately 142°C, thermal shutdown is activated.

# FSL137H

## TYPICAL APPLICATION CIRCUIT

Table 7.

Application	Devices	Input Voltage Range	Output
Adapter	FSL137H	90–264Vac	12 V/1 A (12 W)

### Features

- High efficiency (>77.76% at full load) meeting Energy Star V2.0 regulation with enough margin
- Standby power < 100mW at no-load condition
- Provides full protection functions:

Table 8.

OVP	OTP	OLP	VIN-H	VIN-L
Latch	Latch	Auto Restart	Latch	Auto Restart

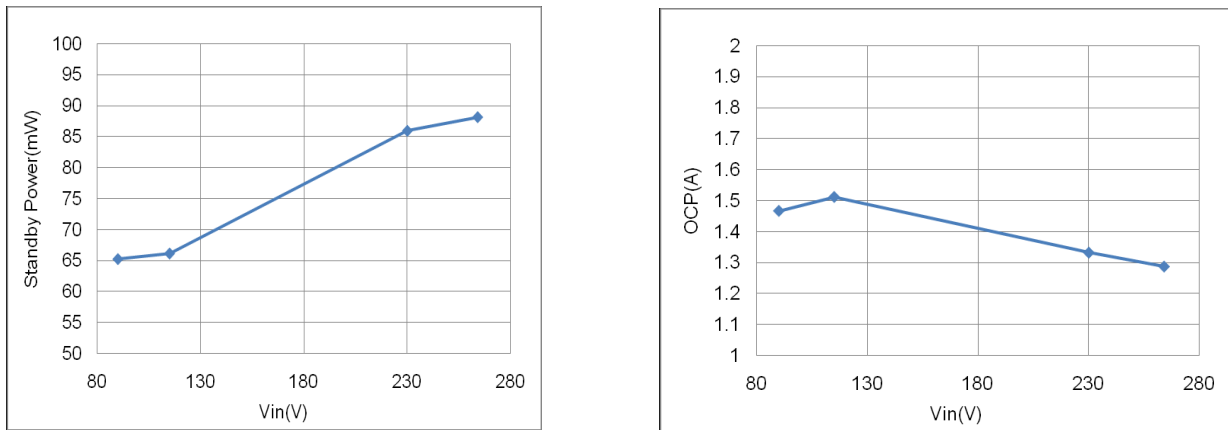

Figure 30. Measured Standby Power and OCP

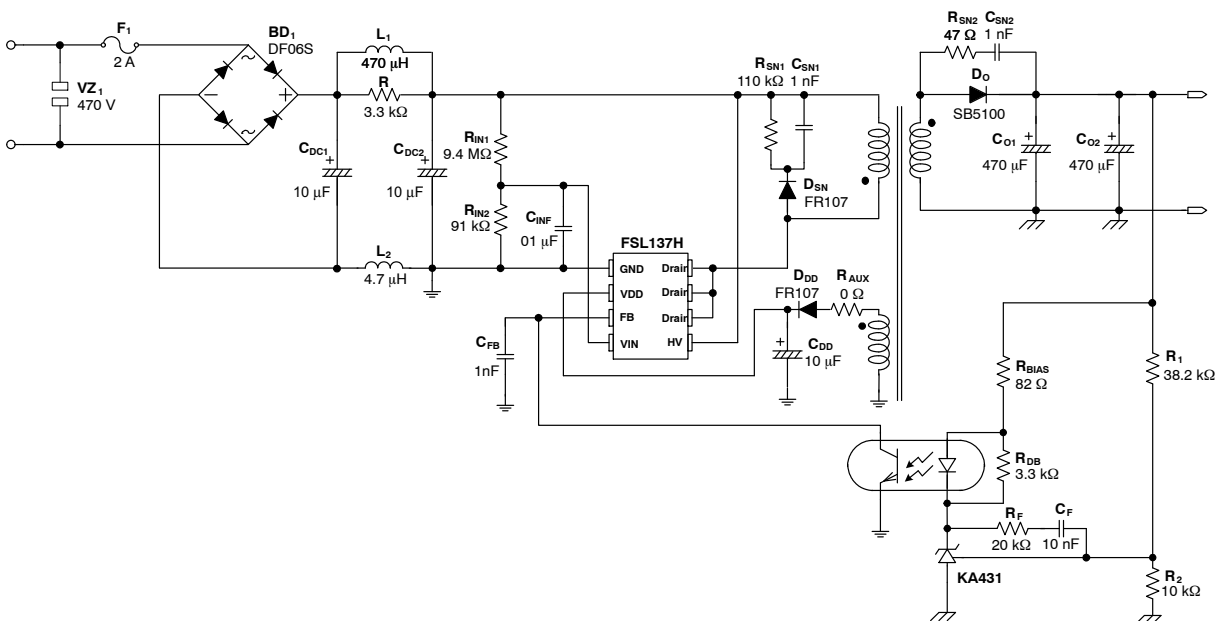

Figure 31. Schematic of Typical Application Circuit

# FSL137H

## TYPICAL APPLICATION CIRCUIT (continued)

### Transformer Specification

- Core: EE16
- Bobbin: EE16

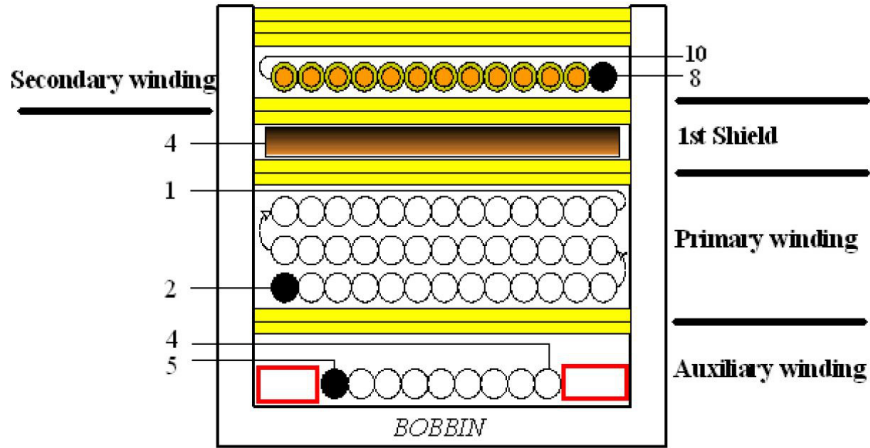

Figure 32. Transformer Diagram

Table 9.

NO.	Terminal		Wire	Ts
	S	F		
W1	5	4	2UEW 0.3*1	13
W2	2	1	2UEW 0.26*1	75
W3	4	-	Copper Shield	1.2
W4	8	10	TEX-E 0.35*1	13
			Core Rounding Tape	3
Primary-Side Inductance = 600 $\mu$ H $\pm$ 5%				
Primary-Side Effective Leakage < 20 $\mu$ H $\pm$ 5%				

SENSEFET is a registered trademark of Semiconductor Components Industries, LLC (SCILLC) or its subsidiaries in the United States and/or other countries.

# MECHANICAL CASE OUTLINE

## PACKAGE DIMENSIONS

ON Semiconductor®



PDIP8 9.59x6.6, 2.54P  
CASE 646CN  
ISSUE O

DATE 31 JUL 2016

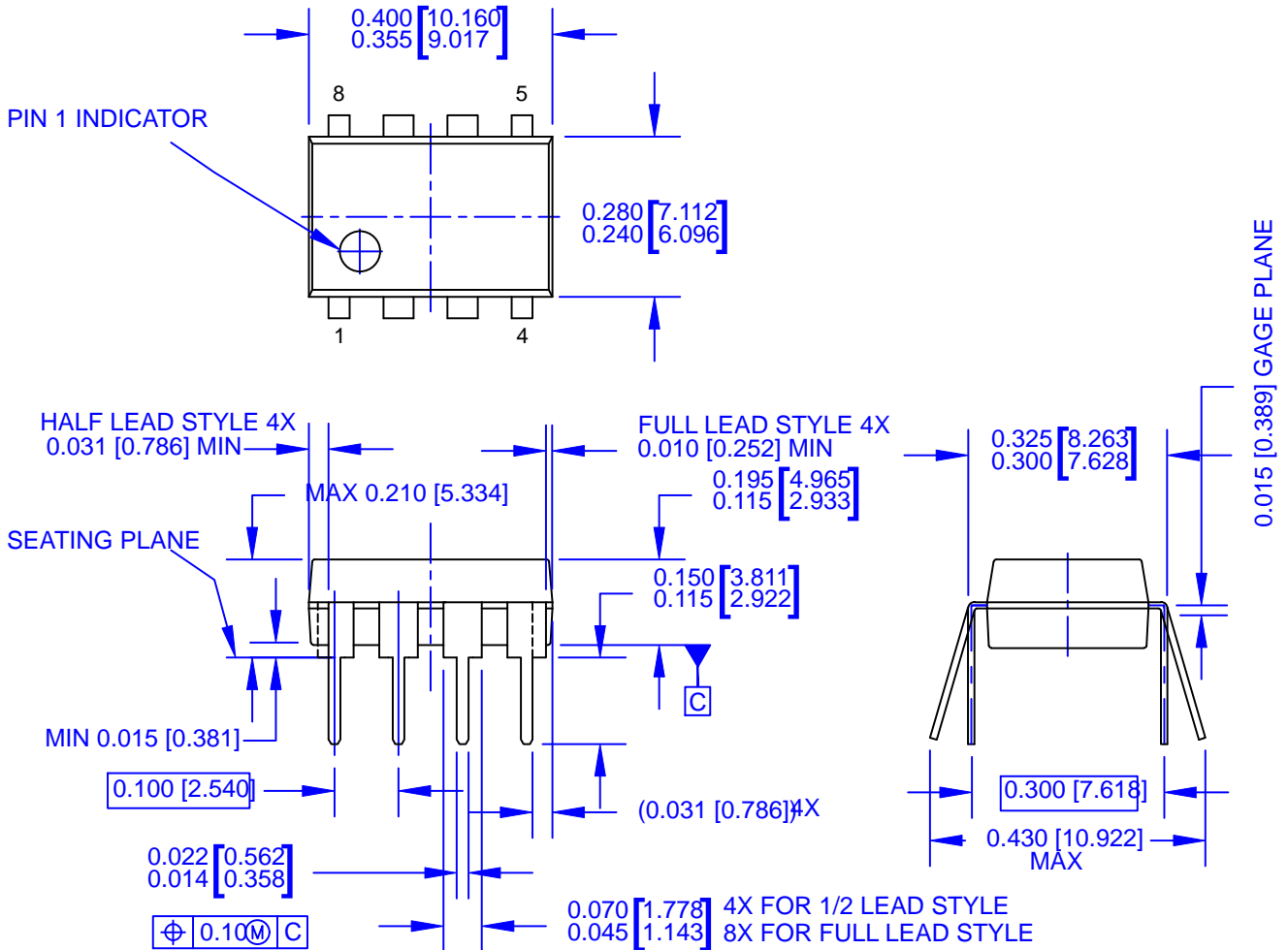

**NOTES:**

- A) THIS PACKAGE CONFORMS TO JEDEC MS-001 VARIATION BA WHICH DEFINES 2 VERSIONS OF THE PACKAGE TERMINAL STYLE WHICH ARE SHOWN HERE.
- B) CONTROLLING DIMS ARE IN INCHES
- C) DIMENSIONS ARE EXCLUSIVE OF BURRS, MOLD FLASH, AND TIE BAR EXTRUSIONS.
- D) DIMENSIONS AND TOLERANCES PER ASME Y14.5M-2009

<b>DOCUMENT NUMBER:</b>	<b>98AON13470G</b>	Electronic versions are uncontrolled except when accessed directly from the Document Repository. Printed versions are uncontrolled except when stamped "CONTROLLED COPY" in red.
<b>STATUS:</b>	<b>ON SEMICONDUCTOR STANDARD</b>	
<b>NEW STANDARD:</b>		
<b>DESCRIPTION:</b>	<b>PDIP8 9.59X6.6, 2.54P</b>	<b>PAGE 1 OF 2</b>



ISSUE	REVISION	DATE
O	RELEASED FOR PRODUCTION FROM FAIRCHILD N08M TO ON SEMICONDUCTOR. REQ. BY I. CAMBALIZA.	31 JUL 2016

ON Semiconductor and ON are registered trademarks of Semiconductor Components Industries, LLC (SCILLC). SCILLC reserves the right to make changes without further notice to any products herein. SCILLC makes no warranty, representation or guarantee regarding the suitability of its products for any particular purpose, nor does SCILLC assume any liability arising out of the application or use of any product or circuit, and specifically disclaims any and all liability, including without limitation special, consequential or incidental damages. "Typical" parameters which may be provided in SCILLC data sheets and/or specifications can and do vary in different applications and actual performance may vary over time. All operating parameters, including "Typicals" must be validated for each customer application by customer's technical experts. SCILLC does not convey any license under its patent rights nor the rights of others. SCILLC products are not designed, intended, or authorized for use as components in systems intended for surgical implant into the body, or other applications intended to support or sustain life, or for any other application in which the failure of the SCILLC product could create a situation where personal injury or death may occur. Should Buyer purchase or use SCILLC products for any such unintended or unauthorized application, Buyer shall indemnify and hold SCILLC and its officers, employees, subsidiaries, affiliates, and distributors harmless against all claims, costs, damages, and expenses, and reasonable attorney fees arising out of, directly or indirectly, any claim of personal injury or death associated with such unintended or unauthorized use, even if such claim alleges that SCILLC was negligent regarding the design or manufacture of the part. SCILLC is an Equal Opportunity/Affirmative Action Employer. This literature is subject to all applicable copyright laws and is not for resale in any manner.

**onsemi**, **Onsemi**, and other names, marks, and brands are registered and/or common law trademarks of Semiconductor Components Industries, LLC dba "**onsemi**" or its affiliates and/or subsidiaries in the United States and/or other countries. **onsemi** owns the rights to a number of patents, trademarks, copyrights, trade secrets, and other intellectual property. A listing of **onsemi**'s product/patent coverage may be accessed at [www.onsemi.com/site/pdf/Patent-Marking.pdf](http://www.onsemi.com/site/pdf/Patent-Marking.pdf). **onsemi** reserves the right to make changes at any time to any products or information herein, without notice. The information herein is provided "as-is" and **onsemi** makes no warranty, representation or guarantee regarding the accuracy of the information, product features, availability, functionality, or suitability of its products for any particular purpose, nor does **onsemi** assume any liability arising out of the application or use of any product or circuit, and specifically disclaims any and all liability, including without limitation special, consequential or incidental damages. Buyer is responsible for its products and applications using **onsemi** products, including compliance with all laws, regulations and safety requirements or standards, regardless of any support or applications information provided by **onsemi**. "Typical" parameters which may be provided in **onsemi** data sheets and/or specifications can and do vary in different applications and actual performance may vary over time. All operating parameters, including "Typicals" must be validated for each customer application by customer's technical experts. **onsemi** does not convey any license under any of its intellectual property rights nor the rights of others. **onsemi** products are not designed, intended, or authorized for use as a critical component in life support systems or any FDA Class 3 medical devices or medical devices with a same or similar classification in a foreign jurisdiction or any devices intended for implantation in the human body. Should Buyer purchase or use **onsemi** products for any such unintended or unauthorized application, Buyer shall indemnify and hold **onsemi** and its officers, employees, subsidiaries, affiliates, and distributors harmless against all claims, costs, damages, and expenses, and reasonable attorney fees arising out of, directly or indirectly, any claim of personal injury or death associated with such unintended or unauthorized use, even if such claim alleges that **onsemi** was negligent regarding the design or manufacture of the part. **onsemi** is an Equal Opportunity/Affirmative Action Employer. This literature is subject to all applicable copyright laws and is not for resale in any manner.

## ADDITIONAL INFORMATION

### TECHNICAL PUBLICATIONS:

Technical Library: [www.onsemi.com/design/resources/technical-documentation](http://www.onsemi.com/design/resources/technical-documentation)  
onsemi Website: [www.onsemi.com](http://www.onsemi.com)

### ONLINE SUPPORT: [www.onsemi.com/support](http://www.onsemi.com/support)

For additional information, please contact your local Sales Representative at [www.onsemi.com/support/sales](http://www.onsemi.com/support/sales)