

Ultra-Low VF Schottky Rectifier, 10 A, 100 V

FSV10100V

Features

- Ultra-Low Forward Voltage Drop
- Low Thermal Resistance
- Very Low Profile: Typical Height of 1.1 mm
- Trench Schottky Technology
- Green Molding Compound as per IEC61249 Standard
- Non-DAP Option Only
- These Devices are Pb-Free, Halogen Free and are RoHS Compliant

Specifications

ABSOLUTE MAXIMUM RATINGS ($T_A = 25^\circ\text{C}$ unless otherwise noted)

| Symbol | Rating | Value | Unit |
|-------------|--|-------------|------------------|
| V_{RRM} | Peak Repetitive Reverse Voltage | 100 | V |
| V_{RWM} | Working Peak Reverse Voltage | 100 | V |
| V_{RMS} | RMS Reverse Voltage | 70 | V |
| V_R | DC Blocking Voltage | 100 | V |
| $I_{F(AV)}$ | Average Rectified Peak Forward Surge Current | 10 | A |
| I_{FSM} | Non-Repetitive Peak Forward Surge Current | 180 | A |
| T_J | Operating Junction Temperature Range | -55 to +150 | $^\circ\text{C}$ |
| T_{STG} | Storage Temperature Range | -55 to +150 | $^\circ\text{C}$ |

Stresses exceeding those listed in the Maximum Ratings table may damage the device. If any of these limits are exceeded, device functionality should not be assumed, damage may occur and reliability may be affected.



ON Semiconductor®

www.onsemi.com



MARKING DIAGRAM

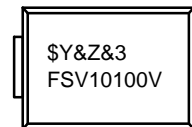

\$Y = ON Semiconductor Logo
 &Z = Assembly Plant Code
 &3 = Date Code (Year & Week)
 FSV10100V = Specific Device Code

ORDERING INFORMATION

See detailed ordering and shipping information on page 2 of this data sheet.

FSV10100V

THERMAL CHARACTERISTICS ($T_A = 25^\circ\text{C}$ unless otherwise noted) (Note 1)

| Symbol | Characteristic | Minimum Land Pattern | Maximum Land Pattern | Unit |
|-----------------|--|----------------------|----------------------|---------------------------|
| $R_{\theta JA}$ | Junction-to-Ambient Thermal Resistance | 100 | 40 | $^\circ\text{C}/\text{W}$ |
| Ψ_{JL} | Junction-to-Lead Thermal Characteristics, Thermocouple Soldered to Anode | 15 | 12 | $^\circ\text{C}/\text{W}$ |
| | Junction-to-Lead Thermal Characteristics, Thermocouple Soldered to Cathode | 6 | 5 | |

1. The thermal resistances ($R_{\theta JA}$ & Ψ_{JL}) are characterized with device mounted on the following FR4 printed circuit boards, as shown in Figure 1 and Figure 2. PCB size: 76.2 x 114.3 mm. Minimum land pattern size: 4.9 x 4.8 mm (big pattern, x1), 1.4 x 1.52 mm (small pattern, x2). Maximum land pattern size: 30 x 30 mm (pattern, x2). Force line trace size = 55 mils, sense line trace size = 4 mils.



Figure 1. Minimum Land Pattern of 2 oz Copper

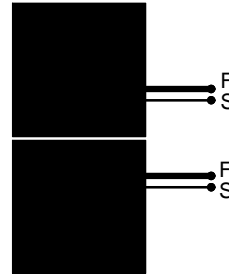

Figure 2. Maximum Land Pattern of 2 oz Copper

ELECTRICAL CHARACTERISTICS ($T_A = 25^\circ\text{C}$ unless otherwise noted)

| Symbol | Parameter | Conditions | Min | Typ | Max | Unit |
|----------|-----------------------|---|-----|--------|-------|------|
| BV_R | Breakdown Voltage | $I_R = 0.5 \text{ mA}$ | 100 | - | - | V |
| V_F | Forward Voltage Drop | $I_F = 5 \text{ A}$ | - | 0.513 | - | V |
| | | $I_F = 5 \text{ A}, T_A = 125^\circ\text{C}$ | - | 0.463 | - | |
| | | $I_F = 10 \text{ A}$ | - | 0.625 | 0.670 | |
| | | $I_F = 10 \text{ A}, T_A = 125^\circ\text{C}$ | - | 0.575 | 0.600 | |
| I_R | Reverse Current | $V_R = 70 \text{ V}$ | - | 0.0072 | - | mA |
| | | $V_R = 70 \text{ V}, T_A = 125^\circ\text{C}$ | - | 6.486 | - | |
| | | $V_R = 100 \text{ V}$ | - | 0.0165 | 0.060 | |
| | | $V_R = 100 \text{ V}, T_A = 125^\circ\text{C}$ | - | 16.72 | 20 | |
| C_J | Junction Capacitance | $V_R = 4 \text{ V}, f = 1 \text{ MHz}$ | - | 796 | - | pF |
| T_{rr} | Reverse Recovery Time | $I_F = 0.5 \text{ A}, I_R = 1 \text{ A}, I_{rr} = 0.25 \text{ A}$ | - | 22.94 | - | ns |

Product parametric performance is indicated in the Electrical Characteristics for the listed test conditions, unless otherwise noted. Product performance may not be indicated by the Electrical Characteristics if operated under different conditions.

ORDERING INFORMATION

| Part Number | Top Mark | Package | Shipping† |
|-------------|-----------|-------------------------------------|--------------------|
| FSV10100V | FSV10100V | TO-277 3L (Pb-Free/Halogen Free) | 5000 / Tape & Reel |

†For information on tape and reel specifications, including part orientation and tape sizes, please refer to our Tape and Reel Packaging Specifications Brochure, BRD8011/D.

TYPICAL PERFORMANCE CHARACTERISTICS

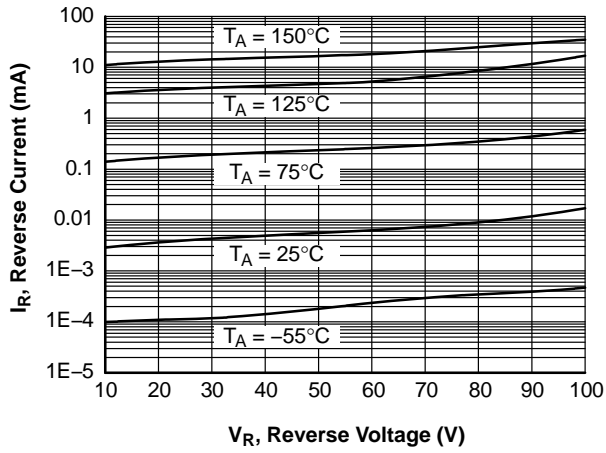

Figure 3. Typical Reverse Characteristics

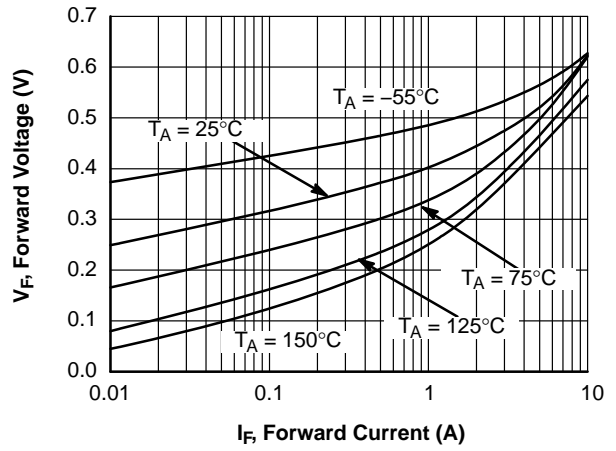

Figure 4. Typical Forward Characteristics

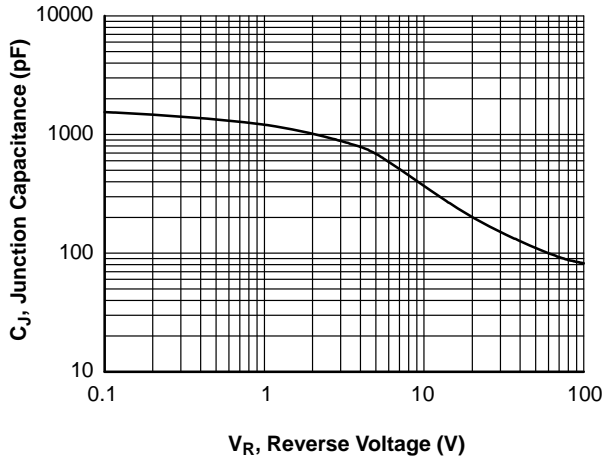

Figure 5. Typical Junction Capacitance

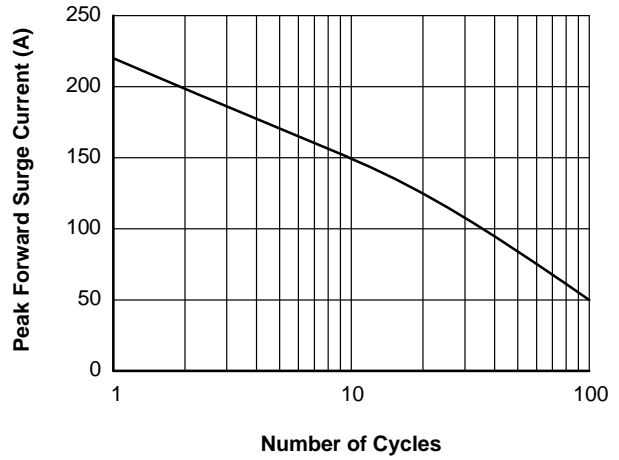

Figure 6. Maximum Non-Repetitive Peak Forward Surge Current

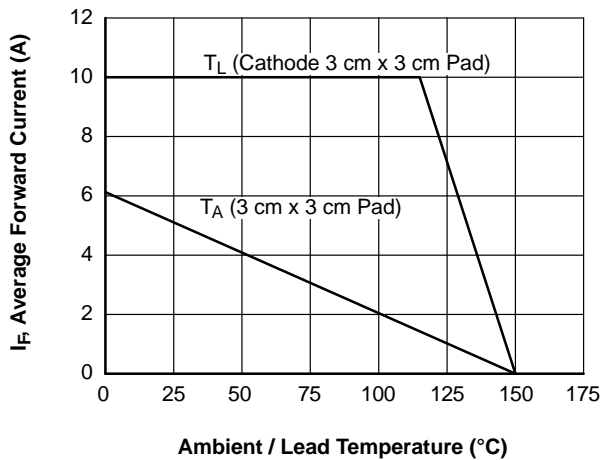

Figure 7. Forward Current Derating Curve

MECHANICAL CASE OUTLINE
PACKAGE DIMENSIONS

TO-277-3LD
CASE 340BQ
ISSUE O

DATE 30 SEP 2016



LAND PATTERN RECOMMENDATION

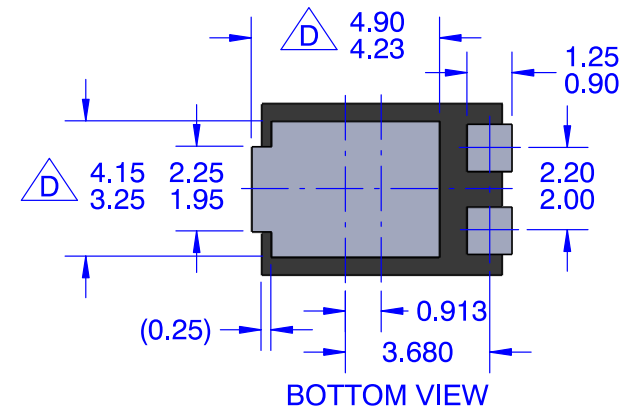

- NOTES: UNLESS OTHERWISE SPECIFIED**
- A. PACKAGE REFERENCE: JEDEC TO-277
 - B. DIMENSIONS ARE EXCLUSIVE OF BURRS, MOLD FLASH, AND TIE BAR EXTRUSIONS.
 - C. ALL DIMENSIONS ARE IN MILLIMETERS.
 - D** DOES NOT COMPLY TO JEDEC STANDARD VALUE.

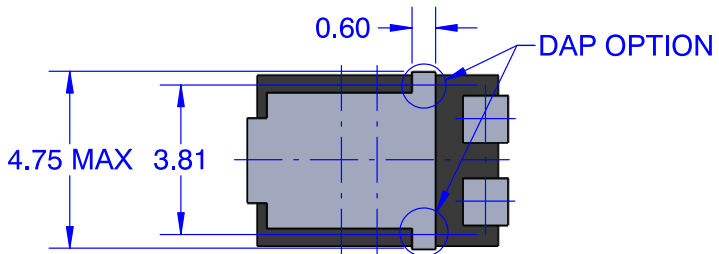

| | | |
|-------------------------|--------------------|--|
| DOCUMENT NUMBER: | 98AON13861G | Electronic versions are uncontrolled except when accessed directly from the Document Repository. Printed versions are uncontrolled except when stamped "CONTROLLED COPY" in red. |
| DESCRIPTION: | TO-277-3LD | PAGE 1 OF 1 |

ON Semiconductor and **ON** are trademarks of Semiconductor Components Industries, LLC dba ON Semiconductor or its subsidiaries in the United States and/or other countries. ON Semiconductor reserves the right to make changes without further notice to any products herein. ON Semiconductor makes no warranty, representation or guarantee regarding the suitability of its products for any particular purpose, nor does ON Semiconductor assume any liability arising out of the application or use of any product or circuit, and specifically disclaims any and all liability, including without limitation special, consequential or incidental damages. ON Semiconductor does not convey any license under its patent rights nor the rights of others.

onsemi, **Onsemi**, and other names, marks, and brands are registered and/or common law trademarks of Semiconductor Components Industries, LLC dba "**onsemi**" or its affiliates and/or subsidiaries in the United States and/or other countries. **onsemi** owns the rights to a number of patents, trademarks, copyrights, trade secrets, and other intellectual property. A listing of **onsemi**'s product/patent coverage may be accessed at www.onsemi.com/site/pdf/Patent-Marking.pdf. **onsemi** reserves the right to make changes at any time to any products or information herein, without notice. The information herein is provided "as-is" and **onsemi** makes no warranty, representation or guarantee regarding the accuracy of the information, product features, availability, functionality, or suitability of its products for any particular purpose, nor does **onsemi** assume any liability arising out of the application or use of any product or circuit, and specifically disclaims any and all liability, including without limitation special, consequential or incidental damages. Buyer is responsible for its products and applications using **onsemi** products, including compliance with all laws, regulations and safety requirements or standards, regardless of any support or applications information provided by **onsemi**. "Typical" parameters which may be provided in **onsemi** data sheets and/or specifications can and do vary in different applications and actual performance may vary over time. All operating parameters, including "Typicals" must be validated for each customer application by customer's technical experts. **onsemi** does not convey any license under any of its intellectual property rights nor the rights of others. **onsemi** products are not designed, intended, or authorized for use as a critical component in life support systems or any FDA Class 3 medical devices or medical devices with a same or similar classification in a foreign jurisdiction or any devices intended for implantation in the human body. Should Buyer purchase or use **onsemi** products for any such unintended or unauthorized application, Buyer shall indemnify and hold **onsemi** and its officers, employees, subsidiaries, affiliates, and distributors harmless against all claims, costs, damages, and expenses, and reasonable attorney fees arising out of, directly or indirectly, any claim of personal injury or death associated with such unintended or unauthorized use, even if such claim alleges that **onsemi** was negligent regarding the design or manufacture of the part. **onsemi** is an Equal Opportunity/Affirmative Action Employer. This literature is subject to all applicable copyright laws and is not for resale in any manner.

ADDITIONAL INFORMATION

TECHNICAL PUBLICATIONS:

Technical Library: www.onsemi.com/design/resources/technical-documentation
onsemi Website: www.onsemi.com

ONLINE SUPPORT: www.onsemi.com/support

For additional information, please contact your local Sales Representative at www.onsemi.com/support/sales