

# MBRS3201P

## 200 V, 3 A Schottky Fast Soft-Recovery Power Rectifier

### SMC Power Surface Mount Package

#### Features

- Lower Forward Voltage than any Ultrafast Rectifier:  
 $V_F < 0.59 \text{ V}$  at  $150^\circ\text{C}$
- Fast Switching Speed: Reverse Recovery Time ( $t_{RR}$ )  $< 35 \text{ ns}$
- Soft Recovery Characteristics: Softness Factor ( $t_b/t_a$ )  $\geq 1$
- Highly Stable Over Temperature
- These Devices are Pb-Free, Halogen Free/BFR Free and are RoHS Compliant

#### Benefits

- Significantly Reduced EMI
- Eliminates the Need of Snubber Circuits
- Low Switching and Heat Losses
- Improved Thermal Management

#### Applications

- Engine and Convenience Control Systems
- Motor Controls
- Battery Chargers and Switching Power Supplies

#### Mechanical Characteristics

- Small Compact Surface Mount Package with J-Bend Leads
- Rectangular Package for Automated Handling
- Weight: 217 mg (Approximately)
- Finish: All External Surfaces Corrosion Resistant and Terminal Leads are Readily Solderable
- ESD Ratings:
  - ◆ Machine Model = A
  - ◆ Human Body Model = 1C
- Lead and Mounting Surface Temperature for Soldering Purposes:  $260^\circ\text{C}$  Maximum for 10 Seconds
- Cathode Polarity Band



ON Semiconductor®

[www.onsemi.com](http://www.onsemi.com)

### SCHOTTKY RECTIFIER 3 AMPS, 200 VOLTS



SMC 2-LEAD  
CASE 403AC



#### MARKING DIAGRAM

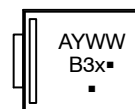

B321 = Specific Device Code  
A = Assembly Location\*  
Y = Year  
WW = Work Week  
▪ = Pb-Free Package

(Note: Microdot may be in either location)

\* The Assembly Location code (A) is front side optional. In cases where the Assembly Location is stamped in the package, the front side assembly code may be blank.

#### ORDERING INFORMATION

Device	Package	Shipping†
MBRS3201PT3G	SMC 2-Lead (Pb-Free)	2500 / Tape & Reel

† For information on tape and reel specifications, including part orientation and tape sizes, please refer to our Tape and Reel Packaging Specification Brochure, BRD8011/D.

# MBRS3201P

## MAXIMUM RATINGS

Characteristic	Symbol	Value	Unit
Peak Repetitive Reverse Voltage Working Peak Reverse Voltage DC Blocking Voltage	$V_{RRM}$ $V_{RWM}$ $V_R$	200	V
Average Rectified Forward Current (Rated $V_R$ , $T_C = 70^\circ\text{C}$ )	$I_{F(AV)}$	3	A
Nonrepetitive Peak Surge Current	$I_{FSM}$	100	A
Operating Junction Temperature	$T_J$	-55 to +150	$^\circ\text{C}$

Stresses exceeding those listed in the Maximum Ratings table may damage the device. If any of these limits are exceeded, device functionality should not be assumed, damage may occur and reliability may be affected.

## THERMAL CHARACTERISTICS

Characteristic	Symbol	Value	Unit
Thermal Resistance, Junction-to-Lead	$R_{\theta JL}$	12	$^\circ\text{C/W}$
Thermal Resistance, Junction-to-Ambient	$R_{\theta JA}$	60	$^\circ\text{C/W}$

## ELECTRICAL CHARACTERISTICS

Characteristic	Symbol	Value	Unit
Maximum Instantaneous Forward Voltage ( $I_F = 3\text{ A}$ , $T_J = 25^\circ\text{C}$ ) ( $I_F = 3\text{ A}$ , $T_J = 150^\circ\text{C}$ )	$V_F$	0.84 0.59	V
Maximum Instantaneous Reverse Current (Rated $V_R$ ) (Rated DC Voltage, $T_J = 25^\circ\text{C}$ ) (Rated DC Voltage, $T_J = 150^\circ\text{C}$ )	$I_R$	1.0 5.0	mA mA
Maximum Reverse Recovery Time ( $I_F = 1\text{ A}$ , $di/dt = 100\text{ A}/\mu\text{s}$ , $V_R = 30\text{ V}$ )	$t_{rr}$	35	ns

Product parametric performance is indicated in the Electrical Characteristics for the listed test conditions, unless otherwise noted. Product performance may not be indicated by the Electrical Characteristics if operated under different conditions.

## TYPICAL CHARACTERISTICS

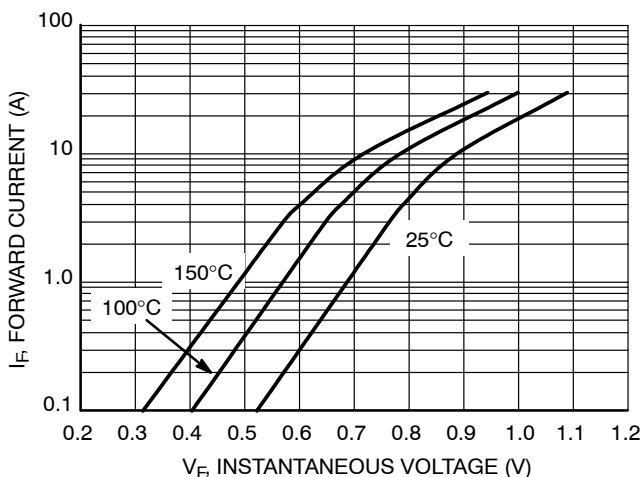

Figure 1. Typical Forward Voltage

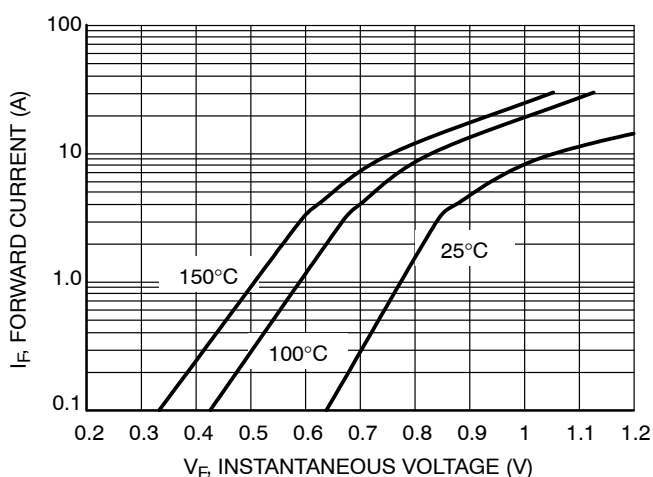

Figure 2. Maximum Forward Voltage

# MBRS3201P

## TYPICAL CHARACTERISTICS

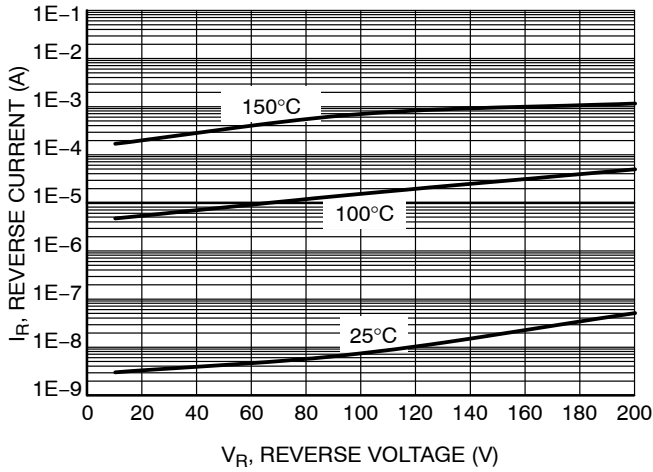

Figure 3. Typical Reverse Current

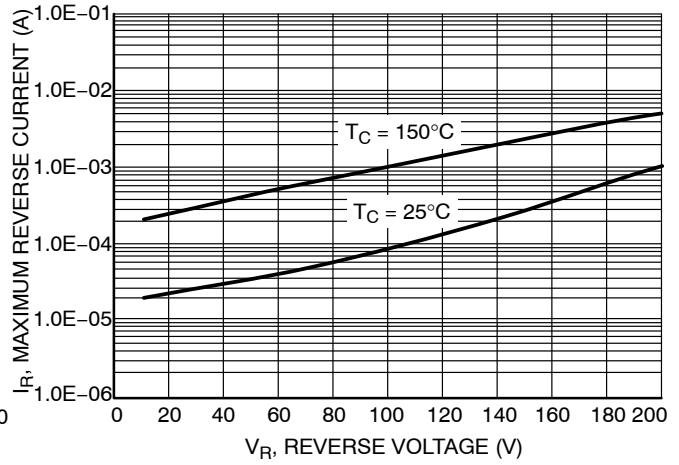

Figure 4. Maximum Reverse Current

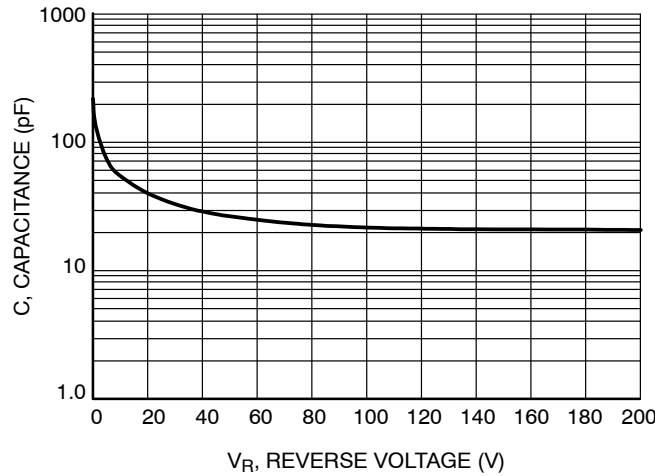

Figure 5. Typical Capacitance

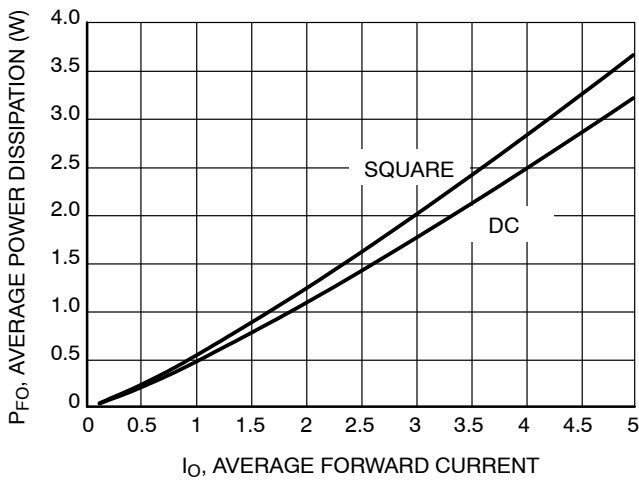

Figure 6. Power Dissipation

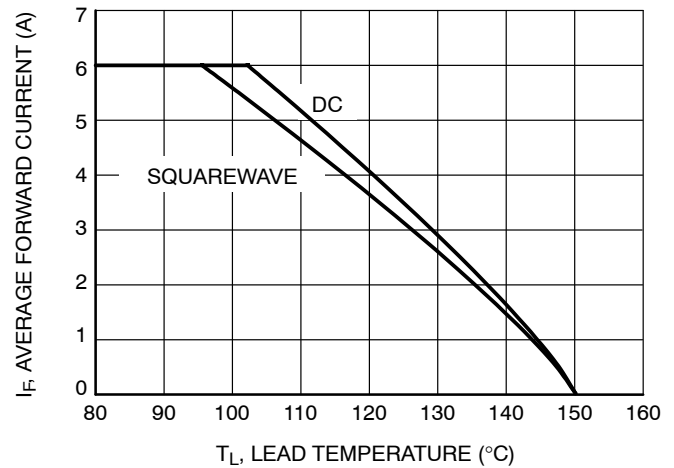

Figure 7. Derating Curve

# MECHANICAL CASE OUTLINE

## PACKAGE DIMENSIONS



SCALE 1:1

SMC 2-LEAD  
CASE 403AC  
ISSUE B

DATE 27 JUL 2017

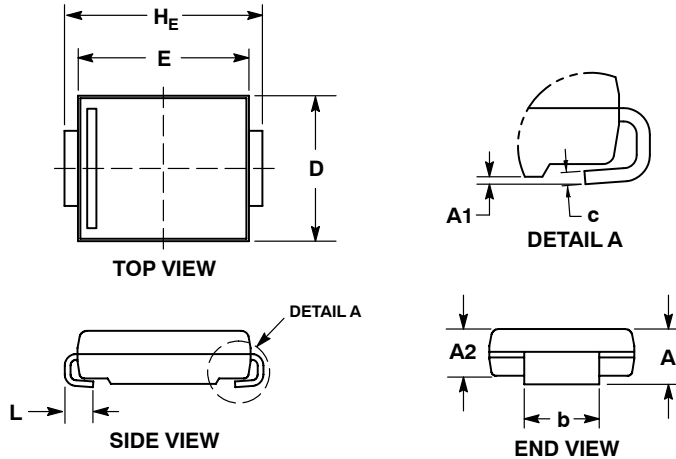

NOTES:

1. DIMENSIONING AND TOLERANCING PER ANME Y14.5M, 1994.
2. CONTROLLING DIMENSION: INCHES.
3. DIMENSIONS D AND E DO NOT INCLUDE MOLD FLASH. MOLD FLASH SHALL NOT EXCEED 0.254mm PER SIDE.
4. DIMENSIONS D AND E TO BE DETERMINED AT DATUM H.
5. DIMENSION b SHALL BE MEASURED WITHIN THE AREA DETERMINED BY DIMENSION L.

DIM	MILLIMETERS		INCHES	
	MIN	MAX	MIN	MAX
A	1.95	2.61	0.077	0.103
A1	0.05	0.20	0.002	0.008
A2	1.90	2.41	0.075	0.095
b	2.90	3.20	0.114	0.126
c	0.15	0.41	0.006	0.016
D	5.55	6.25	0.219	0.246
E	6.60	7.15	0.260	0.281
HE	7.75	8.15	0.305	0.321
L	0.75	1.60	0.030	0.063

RECOMMENDED  
SOLDERING FOOTPRINT\*

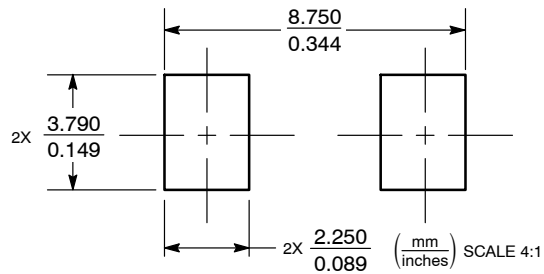

\*For additional information on our Pb-Free strategy and soldering details, please download the **onsemi** Soldering and Mounting Techniques Reference Manual, SOLDERRM/D.

GENERIC  
MARKING DIAGRAM\*

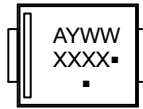

- XXXX = Specific Device Code
- A = Assembly Location
- Y = Year
- WW = Work Week
- = Pb-Free Package

(Note: Microdot may be in either location)

\*This information is generic. Please refer to device data sheet for actual part marking. Pb-Free indicator, "G" or microdot "▪", may or may not be present. Some products may not follow the Generic Marking.

DOCUMENT NUMBER:	98AON97675F	Electronic versions are uncontrolled except when accessed directly from the Document Repository. Printed versions are uncontrolled except when stamped "CONTROLLED COPY" in red.
DESCRIPTION:	SMC 2-LEAD	PAGE 1 OF 1

**onsemi** and **ONSEMI** are trademarks of Semiconductor Components Industries, LLC dba **onsemi** or its subsidiaries in the United States and/or other countries. **onsemi** reserves the right to make changes without further notice to any products herein. **onsemi** makes no warranty, representation or guarantee regarding the suitability of its products for any particular purpose, nor does **onsemi** assume any liability arising out of the application or use of any product or circuit, and specifically disclaims any and all liability, including without limitation special, consequential or incidental damages. **onsemi** does not convey any license under its patent rights nor the rights of others.

**onsemi**, **Onsemi**, and other names, marks, and brands are registered and/or common law trademarks of Semiconductor Components Industries, LLC dba "**onsemi**" or its affiliates and/or subsidiaries in the United States and/or other countries. **onsemi** owns the rights to a number of patents, trademarks, copyrights, trade secrets, and other intellectual property. A listing of **onsemi**'s product/patent coverage may be accessed at [www.onsemi.com/site/pdf/Patent-Marking.pdf](http://www.onsemi.com/site/pdf/Patent-Marking.pdf). **onsemi** reserves the right to make changes at any time to any products or information herein, without notice. The information herein is provided "as-is" and **onsemi** makes no warranty, representation or guarantee regarding the accuracy of the information, product features, availability, functionality, or suitability of its products for any particular purpose, nor does **onsemi** assume any liability arising out of the application or use of any product or circuit, and specifically disclaims any and all liability, including without limitation special, consequential or incidental damages. Buyer is responsible for its products and applications using **onsemi** products, including compliance with all laws, regulations and safety requirements or standards, regardless of any support or applications information provided by **onsemi**. "Typical" parameters which may be provided in **onsemi** data sheets and/or specifications can and do vary in different applications and actual performance may vary over time. All operating parameters, including "Typicals" must be validated for each customer application by customer's technical experts. **onsemi** does not convey any license under any of its intellectual property rights nor the rights of others. **onsemi** products are not designed, intended, or authorized for use as a critical component in life support systems or any FDA Class 3 medical devices or medical devices with a same or similar classification in a foreign jurisdiction or any devices intended for implantation in the human body. Should Buyer purchase or use **onsemi** products for any such unintended or unauthorized application, Buyer shall indemnify and hold **onsemi** and its officers, employees, subsidiaries, affiliates, and distributors harmless against all claims, costs, damages, and expenses, and reasonable attorney fees arising out of, directly or indirectly, any claim of personal injury or death associated with such unintended or unauthorized use, even if such claim alleges that **onsemi** was negligent regarding the design or manufacture of the part. **onsemi** is an Equal Opportunity/Affirmative Action Employer. This literature is subject to all applicable copyright laws and is not for resale in any manner.

## ADDITIONAL INFORMATION

### TECHNICAL PUBLICATIONS:

Technical Library: [www.onsemi.com/design/resources/technical-documentation](http://www.onsemi.com/design/resources/technical-documentation)  
onsemi Website: [www.onsemi.com](http://www.onsemi.com)

### ONLINE SUPPORT: [www.onsemi.com/support](http://www.onsemi.com/support)

For additional information, please contact your local Sales Representative at [www.onsemi.com/support/sales](http://www.onsemi.com/support/sales)