

3.3 V Automotive Grade LVDS Driver

NBA3N011S

Description

The NBA3N011S is a Low Voltage Differential Signaling (LVDS) driver for low power and high data rate applications. The device accepts LVCMOS/TTL input and translates it to LVDS and is designed to support data rates higher than 400 Mbps (200 MHz).

The driver provides low EMI with a typical output swing of 350 mV. The device can be paired with its companion single line receiver NBA3N012C or with any other LVDS receiver for high speed LVDS interface.

The LVDS output is designed as a 3.5 mA (typical) current mode driver allowing low power dissipation even at the high frequency.

NBA3N011S is offered in a 5 lead SOT23 package, shipping in 3000 pcs tape & reel.

Features

- Compatible with TIA/EIA-644A Standard
- Automotive Grade AECQ-100 Grade 1
- > 400 Mbps (200 MHz) Data Rate
- Operating Range: $V_{DD} = 3.3\text{ V} \pm 0.3\text{ V}$
- Maximum 700 ps Differential Skew
- Maximum Propagation Delay of 1.5 ns
- Low Power Dissipation (Typical 23 mW @ 3.3 V)
- SOT23-5 Lead Package with Pinout optimized for easy PCB Layout
- $\pm 350\text{ mV}$ Differential Signaling
- Power Off Protection (Outputs in Tri-state)
- Temperature Operating Range -40°C to $+125^{\circ}\text{C}$
- These are Pb-Free Devices

Typical Applications:

- Automotive: Head Lamp Lighting for Cars
- Telecom: Wireless, Microwave and Optical

Table 1. PIN DESCRIPTION

Pin Number	Pin Name	I/O Type	Description
1	V_{DD}		Power Supply Pin
2	GND		Ground Pin
3	\bar{Q}	Output	Inverting Output Pin
4	Q	Output	Non-Inverting Output
5	IN	Input	Input Pin



SOT23-5
DT SUFFIX
CASE 527AH

MARKING DIAGRAM

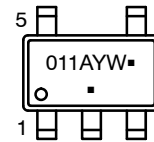

011 = Specific Device Code
A = Assembly Code
Y = Year
W = Work Week
▪ = Pb-Free Package

(Note: Microdot may be in either location)

LOGIC DIAGRAM

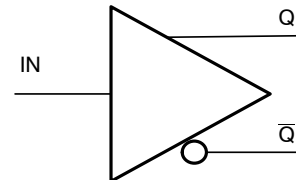

PINOUT DIAGRAM

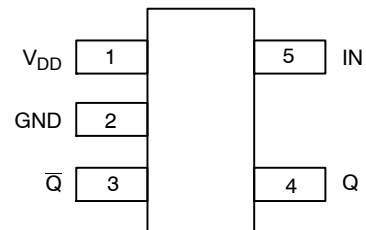

ORDERING INFORMATION

Device	Package	Shipping [†]
NBA3N011SSNT1G	SOT23-5 (Pb-Free)	3000 / Tape & Reel

[†]For information on tape and reel specifications, including part orientation and tape sizes, please refer to our Tape and Reel Packaging Specification Brochure, BRD8011/D.

NBA3N011S

Table 2. ATTRIBUTES (Note 1)

Characteristics			Value
ESD Protection	Human Body Model (JEDEC Standard 22, Method A114-E)	All Pins	≥ 8 kV
	Charge Device Model (JEDEC Standard 22, Method C101D)	All Pins	≥ 1.25 kV
Moisture Sensitivity (Note 1)			Level 1
Flammability Rating	Oxygen Index: 28 to 34		UL 94 Code V-0 A 0.125 in 28 to 34

1. For additional information, see Application Note AND8003/D

Table 3. MAXIMUM RATINGS

Symbol	Parameter	Rating	Unit
V _{DD}	Supply voltage	-0.30 ≤ V _{DD} ≤ 4.0	V
V _{IN}	Input Voltage (IN) LVCMOS	-0.30 to (V _{DD} + 0.30)	V
V _Q	Output Voltage (Q/Q) LVDS	-0.30 to +3.90	V
I _{OS}	Output Short Circuit Current LVDS	24	mA
T _j	Maximum Junction Temperature	135	°C
T _{stg}	Storage Temperature Range	-65 to +150	°C
θ _{JC}	Thermal resistance (Junction-to-Case) – (Note 3)	107	°C/W
θ _{JA}	Thermal resistance (Junction-to-Ambient) – (Note 3)	138.5	°C/W
T _{sol}	Lead Temperature Soldering (4 Seconds) – SOLDERM/D	260	°C
PD	Package Power Dissipation @ 25°C – Derating of 7.22 mW/°C above 25°C	794	mW

Stresses exceeding those listed in the Maximum Ratings table may damage the device. If any of these limits are exceeded, device functionality should not be assumed, damage may occur and reliability may be affected.

- The maximum ratings applied are individual stress limit values and not valid simultaneously.
- JEDEC standard multilayer board –2S2P (2 signal 2 power)

Table 4. DC CHARACTERISTICS V_{DD} = 3.3 V ± 0.3 V, GND = 0 V, T_A = -40°C to +125°C

Symbol	Parameter	Test Conditions	Min	Typ	Max	Unit
I _{DD}	Power Supply Current	No-Load (Pin: V _{DD} ; V _{IN} = V _{DD} or GND)		5	8	mA
		RL = 100 Ω (Pin: V _{DD} ; V _{IN} = V _{DD} or GND)		7	10	mA
V _{IH}	Input High Voltage	Pin: IN	2.0		V _{DD}	V
V _{IL}	Input Low Voltage	Pin: IN	GND		0.8	V
I _{IH}	Input High Current	Pin: IN; V _{IN} = 3.3 V or 2.4 V		±2	±10	μA
I _{IL}	Input Low Current	Pin: IN; V _{IN} = GND or 0.5 V		±1	±10	μA
V _{CL}	Input Clamp Voltage	I _{CL} = -18 mA	-1.5	-0.6		V
C _{IN}	Input Capacitance			3		pF

Product parametric performance is indicated in the Electrical Characteristics for the listed test conditions, unless otherwise noted. Product performance may not be indicated by the Electrical Characteristics if operated under different conditions.

NBA3N011S

Table 5. ELECTRICAL CHARACTERISTICS $V_{DD} = 3.3 \text{ V} \pm 0.3 \text{ V}$, $GND = 0 \text{ V}$, $T_A = -40^\circ\text{C}$ to $+125^\circ\text{C}$, Pin: Q/ \bar{Q}

Symbol	Parameter	Test Conditions	Min	Typ	Max	Unit
$ V_{OD} $	Differential Output Voltage	$R_L = 100 \Omega$, Figures 1 & 2	250	350	450	mV
$\Delta V_{OD} $	Change in Differential Output Voltage magnitude			3	35	mV
V_{OS}	Offset Voltage	$R_L = 100 \Omega$, Figure 1	1.125	1.220	1.375	V
ΔV_{OS}	Change in Offset Voltage magnitude		0	1	50	mV
I_{OFF}	Leakage Current – Power-off	$V_Q = 3.6 \text{ V}$ or GND , $V_{DD} = 0 \text{ V}$		± 1	± 10	μA
I_{OSD}	Differential Short Circuit Output Current (Note 4)	$V_{OD} = 0 \text{ V}$		-5	-12	mA
I_{OS}	Output Short Circuit Current (Note 4)	V_Q and $\bar{V}_Q = 0 \text{ V}$		-6	-24	mA
C_{OUT}	Output Capacitance			3		pF

4. - minus sign indicated only direction. Current into the device is defined as positive. I_{OS}/I_{OSD} is specified as magnitude only.

Table 6. SWITCHING CHARACTERISTICS

$V_{DD} = 3.3 \text{ V} \pm 0.3 \text{ V}$, $GND = 0 \text{ V}$, $T_A = -40^\circ\text{C}$ to $+125^\circ\text{C}$, $F = 1 \text{ MHz}$, $Z_O = 50 \Omega$, $t_r, t_f \leq 1 \text{ ns}$ (10% to 90%) – (Note 5)

Symbol	Parameters	Min	Typ	Max	Unit
t_{pHLD}	High to Low Differential Propagation Delay	0.3	1.0	1.5	ns
t_{pLHD}	Low to High Differential Propagation Delay	0.3	1.1	1.5	ns
t_r	Rise Time – Transition Low to High	0.2	0.5	1.0	ns
t_f	Fall Time – Transition High to Low	0.2	0.5	1.0	ns
$t_{SKD(P)}$	Differential Pulse Skew $ t_{pHLD} - t_{pLHD} $ (Note 6)	0	0.1	0.7	ns
$t_{SKD(PP)1}$	Differential Part to Part Skew – (Note 7)	0	0.2	1.0	ns
$t_{SKD(PP)2}$	Differential Part to Part Skew – (Note 8)	0	0.4	1.2	ns
f_{MAX}	Maximum Operating Frequency – (Note 9)		250		MHz

5. Test Conditions for the above – $R_L = 100 \Omega$, $C_L = 15 \text{ pF}$ (includes Load & Jig Capacitance), Figures 3 and 4

Product parametric performance is indicated in the Electrical Characteristics for the listed test conditions, unless otherwise noted. Product performance may not be indicated by the Electrical Characteristics if operated under different conditions

- $|t_{pHLD} - t_{pLHD}|$, is the magnitude difference in differential propagation delay time between the positive going edge and the negative going edge of the same channel.
- Differential Part to Part Skew, is defined as the difference between the minimum and maximum specified differential propagation delays. This specification applies to devices at the same V_{DD} and within 5°C of each other within the operating temperature range.
- Part to part skew, is the differential channel to channel skew of any event between devices. This specification applies to devices over recommended operating temperature and voltage ranges, and across process distribution. t_{SKD2} is defined as $|Max - Min|$ differential propagation delay.
- f_{MAX} Input Conditions: $t_r = t_f < 1 \text{ ns}$ (0% to 100%), Duty Cycle 50%, 0 V to 3 V. f_{MAX} Output Conditions: $V_{OD} > 250 \text{ mV}$, Duty Cycle = 45%/55%

NBA3N011S

PARAMETER MEASUREMENT:

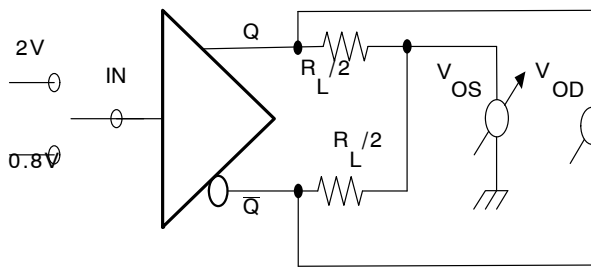

Figure 1. DC Test Circuit for Differential Driver

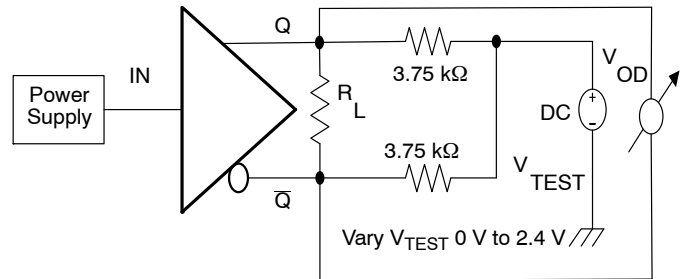

Figure 2. Full Load DC Test Circuit for Differential Driver

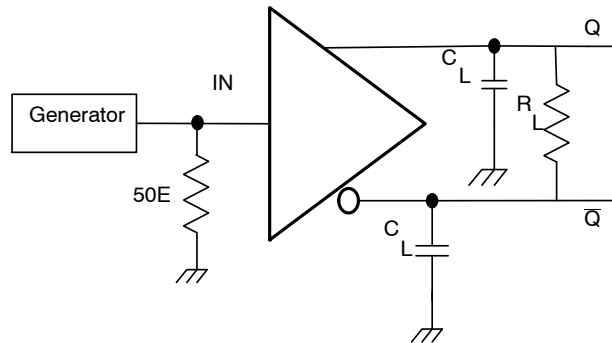

Figure 3. Propagation Delay & Transition Time Test Circuit for Differential Driver

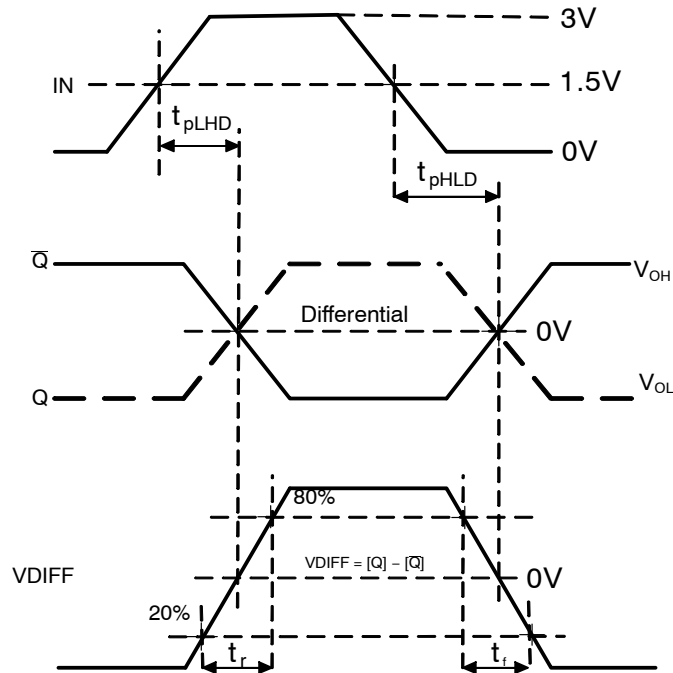
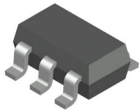

Figure 4. Propagation Delay & Transition Time Waveforms for Differential Driver

MECHANICAL CASE OUTLINE PACKAGE DIMENSIONS

ON Semiconductor®



SOT-23, 5 Lead CASE 527AH ISSUE A

DATE 09 JUN 2021

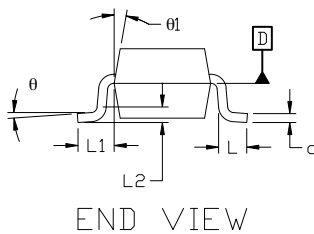
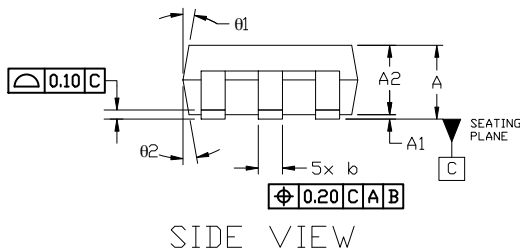
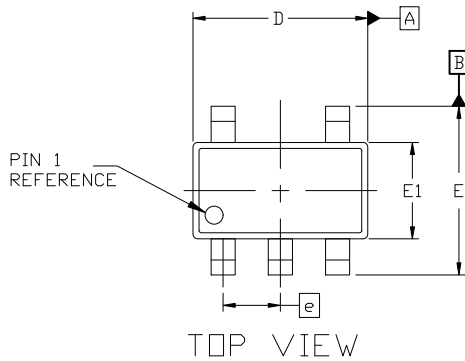

GENERIC MARKING DIAGRAM*

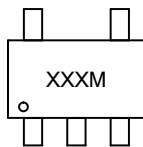

XXX = Specific Device Code
M = Date Code

*This information is generic. Please refer to device data sheet for actual part marking. Pb-Free indicator, "G" or microdot "•", may or may not be present. Some products may not follow the Generic Marking.

NOTES:

1. DIMENSIONING AND TOLERANCING PER ASME Y14.5M, 1989A
2. CONTROLLING DIMENSION: MILLIMETERS
3. MAXIMUM LEAD THICKNESS INCLUDES LEAD FINISH THICKNESS. MINIMUM LEAD THICKNESS IS THE MINIMUM THICKNESS OF THE BASE MATERIAL.
4. DIMENSIONS D AND E1 DO NOT INCLUDE MOLD FLASH, PROTRUSIONS, OR GATE BURRS. MOLD FLASH, PROTRUSIONS, OR GATE BURRS SHALL NOT EXCEED 0.25 PER SIDE. D AND E1 DIMENSIONS ARE DETERMINED AT DATUM D.
5. DIMENSION 'b' DOES NOT INCLUDE DAMBAR PROTRUSION. ALLOWABLE DAMBAR PROTRUSION SHALL BE 0.08mm TOTAL IN EXCESS OF THE 'b' DIMENSION AT MAXIMUM MATERIAL CONDITION. MINIMUM SPACE BETWEEN PROTRUSION AND AN ADJACENT LEAD SHALL NOT BE LESS THAN 0.07mm.

DIM	MILLIMETERS		
	MIN.	NOM.	MAX.
A	0.90	—	1.45
A1	0.00	—	0.15
A2	0.90	1.15	1.30
b	0.30	—	0.50
c	0.08	—	0.22
D	2.90 BSC		
E	2.80 BSC		
E1	1.60 BSC		
e	0.95 BSC		
L	0.30	0.45	0.60
L1	0.60 REF		
L2	0.25 REF		
θ	0°	4°	8°
θ1	0°	10°	15°
θ2	0°	10°	15°

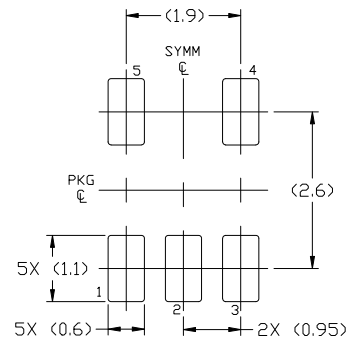

For additional information on our Pb-Free strategy and soldering details, please download the ON Semiconductor Soldering and Mounting Techniques Reference Manual, SOLDERRM/D.

DOCUMENT NUMBER:	98AON34320E	Electronic versions are uncontrolled except when accessed directly from the Document Repository. Printed versions are uncontrolled except when stamped "CONTROLLED COPY" in red.
DESCRIPTION:	SOT-23, 5 LEAD	PAGE 1 OF 1

ON Semiconductor and ON are trademarks of Semiconductor Components Industries, LLC dba ON Semiconductor or its subsidiaries in the United States and/or other countries. ON Semiconductor reserves the right to make changes without further notice to any products herein. ON Semiconductor makes no warranty, representation or guarantee regarding the suitability of its products for any particular purpose, nor does ON Semiconductor assume any liability arising out of the application or use of any product or circuit, and specifically disclaims any and all liability, including without limitation special, consequential or incidental damages. ON Semiconductor does not convey any license under its patent rights nor the rights of others.

onsemi, **Onsemi**, and other names, marks, and brands are registered and/or common law trademarks of Semiconductor Components Industries, LLC dba "**onsemi**" or its affiliates and/or subsidiaries in the United States and/or other countries. **onsemi** owns the rights to a number of patents, trademarks, copyrights, trade secrets, and other intellectual property. A listing of **onsemi**'s product/patent coverage may be accessed at www.onsemi.com/site/pdf/Patent-Marking.pdf. **onsemi** reserves the right to make changes at any time to any products or information herein, without notice. The information herein is provided "as-is" and **onsemi** makes no warranty, representation or guarantee regarding the accuracy of the information, product features, availability, functionality, or suitability of its products for any particular purpose, nor does **onsemi** assume any liability arising out of the application or use of any product or circuit, and specifically disclaims any and all liability, including without limitation special, consequential or incidental damages. Buyer is responsible for its products and applications using **onsemi** products, including compliance with all laws, regulations and safety requirements or standards, regardless of any support or applications information provided by **onsemi**. "Typical" parameters which may be provided in **onsemi** data sheets and/or specifications can and do vary in different applications and actual performance may vary over time. All operating parameters, including "Typicals" must be validated for each customer application by customer's technical experts. **onsemi** does not convey any license under any of its intellectual property rights nor the rights of others. **onsemi** products are not designed, intended, or authorized for use as a critical component in life support systems or any FDA Class 3 medical devices or medical devices with a same or similar classification in a foreign jurisdiction or any devices intended for implantation in the human body. Should Buyer purchase or use **onsemi** products for any such unintended or unauthorized application, Buyer shall indemnify and hold **onsemi** and its officers, employees, subsidiaries, affiliates, and distributors harmless against all claims, costs, damages, and expenses, and reasonable attorney fees arising out of, directly or indirectly, any claim of personal injury or death associated with such unintended or unauthorized use, even if such claim alleges that **onsemi** was negligent regarding the design or manufacture of the part. **onsemi** is an Equal Opportunity/Affirmative Action Employer. This literature is subject to all applicable copyright laws and is not for resale in any manner.

ADDITIONAL INFORMATION

TECHNICAL PUBLICATIONS:

Technical Library: www.onsemi.com/design/resources/technical-documentation
onsemi Website: www.onsemi.com

ONLINE SUPPORT: www.onsemi.com/support

For additional information, please contact your local Sales Representative at www.onsemi.com/support/sales

