

IGBT - Field Stop II NGTB40N65FL2WG

This Insulated Gate Bipolar Transistor (IGBT) features a robust and cost effective Field Stop II Trench construction, and provides superior performance in demanding switching applications, offering both low on state voltage and minimal switching loss. The IGBT is well suited for UPS and solar applications. Incorporated into the device is a soft and fast co-packaged free wheeling diode with a low forward voltage.

Features

- Extremely Efficient Trench with Field Stop Technology
- $T_{Jmax} = 175^{\circ}C$
- Soft Fast Reverse Recovery Diode
- Optimized for High Speed Switching
- 5 μs Short-Circuit Capability
- These are Pb-Free Devices

Typical Applications

- Solar Inverters
- Uninterruptible Power Supplies (UPS)
- Welding

ABSOLUTE MAXIMUM RATINGS

Rating	Symbol	Value	Unit
Collector-emitter Voltage	V_{CES}	650	V
Collector Current @ $T_C = 25^{\circ}C$ @ $T_C = 100^{\circ}C$	I_C	80 40	A
Diode Forward Current @ $T_C = 25^{\circ}C$ @ $T_C = 100^{\circ}C$	I_F	80 40	A
Diode Pulsed Current T_{PULSE} Limited by T_J Max	I_{FM}	160	A
Pulsed Collector Current, T_{pulse} Limited by T_{Jmax}	I_{CM}	160	A
Short-circuit Withstand Time $V_{GE} = 15 V, V_{CE} = 400 V,$ $T_J \leq +150^{\circ}C$	t_{SC}	5	μs
Gate-emitter Voltage	V_{GE}	± 20	V
Transient Gate-emitter Voltage ($T_{PULSE} = 5 \mu s, D < 0.10$)		± 30	V
Power Dissipation @ $T_C = 25^{\circ}C$ @ $T_C = 100^{\circ}C$	P_D	366 183	W
Operating Junction Temperature Range	T_J	-55 to +175	$^{\circ}C$
Storage Temperature Range	T_{stg}	-55 to +175	$^{\circ}C$
Lead temperature for soldering, 1/8" from case for 5 seconds	T_{SLD}	260	$^{\circ}C$

Stresses exceeding those listed in the Maximum Ratings table may damage the device. If any of these limits are exceeded, device functionality should not be assumed, damage may occur and reliability may be affected.

40 A, 650 V
 $V_{CEsat} = 1.7 V$
 $E_{off} = 0.44 mJ$

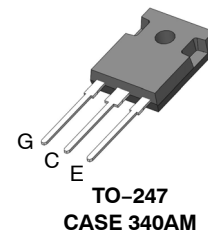
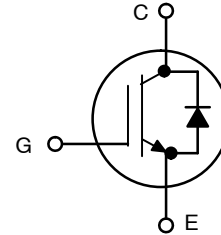

MARKING DIAGRAM

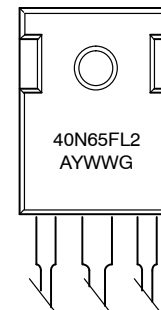

40N65FL2 = Specific Device Code
A = Assembly Location
Y = Year
WW = Work Week
G = Pb-Free Package

ORDERING INFORMATION

Device	Package	Shipping
NGTB40N65FL2WG	TO-247 (Pb-Free)	30 Units / Rail

NGTB40N65FL2WG

THEMAL CHARACTERISTICS

Rating	Symbol	Value	Unit
Thermal resistance junction-to-case, for IGBT	$R_{\theta JC}$	0.41	$^{\circ}\text{C}/\text{W}$
Thermal resistance junction-to-case, for Diode	$R_{\theta JC}$	1.00	$^{\circ}\text{C}/\text{W}$
Thermal resistance junction-to-ambient	$R_{\theta JA}$	40	$^{\circ}\text{C}/\text{W}$

ELECTRICAL CHARACTERISTICS ($T_J = 25^{\circ}\text{C}$ unless otherwise specified)

Parameter	Test Conditions	Symbol	Min	Typ	Max	Unit
-----------	-----------------	--------	-----	-----	-----	------

STATIC CHARACTERISTIC

Collector-emitter breakdown voltage, gate-emitter short-circuited	$V_{GE} = 0\text{ V}, I_C = 500\ \mu\text{A}$	$V_{(BR)CES}$	650	-	-	V
Collector-emitter saturation voltage	$V_{GE} = 15\text{ V}, I_C = 40\text{ A}$ $V_{GE} = 15\text{ V}, I_C = 40\text{ A}, T_J = 175^{\circ}\text{C}$	V_{CEsat}	1.50 -	1.70 2.10	2.00 -	V
Gate-emitter threshold voltage	$V_{GE} = V_{CE}, I_C = 350\ \mu\text{A}$	$V_{GE(th)}$	4.5	5.5	6.5	V
Collector-emitter cut-off current, gate-emitter short-circuited	$V_{GE} = 0\text{ V}, V_{CE} = 650\text{ V}$ $V_{GE} = 0\text{ V}, V_{CE} = 650\text{ V}, T_J = 175^{\circ}\text{C}$	I_{CES}	-	-	0.5 7.0	mA
Gate leakage current, collector-emitter short-circuited	$V_{GE} = 20\text{ V}, V_{CE} = 0\text{ V}$	I_{GES}	-	-	200	nA

DYNAMIC CHARACTERISTIC

Input capacitance	$V_{CE} = 20\text{ V}, V_{GE} = 0\text{ V}, f = 1\text{ MHz}$	C_{ies}	-	4060	-	pF
Output capacitance		C_{oes}	-	179	-	
Reverse transfer capacitance		C_{res}	-	115	-	
Gate charge total	$V_{CE} = 480\text{ V}, I_C = 40\text{ A}, V_{GE} = 15\text{ V}$	Q_g	-	170	-	nC
Gate to emitter charge		Q_{ge}	-	41	-	
Gate to collector charge		Q_{gc}	-	87	-	

SWITCHING CHARACTERISTIC, INDUCTIVE LOAD

Turn-on delay time	$T_J = 25^{\circ}\text{C}$ $V_{CC} = 400\text{ V}, I_C = 40\text{ A}$ $R_g = 10\ \Omega$ $V_{GE} = 0\text{ V}/15\text{ V}$	$t_{d(on)}$	-	84	-	ns	
Rise time		t_r	-	40	-		
Turn-off delay time		$t_{d(off)}$	-	177	-		
Fall time			t_f	-	70	-	mJ
Turn-on switching loss		E_{on}	-	0.97	-		
Turn-off switching loss		E_{off}	-	0.44	-		
Total switching loss		E_{ts}	-	1.41	-		
Turn-on delay time		$T_J = 150^{\circ}\text{C}$ $V_{CC} = 400\text{ V}, I_C = 40\text{ A}$ $R_g = 10\ \Omega$ $V_{GE} = 0\text{ V}/15\text{ V}$	$t_{d(on)}$	-	82	-	ns
Rise time			t_r	-	40	-	
Turn-off delay time	$t_{d(off)}$		-	183	-		
Fall time			t_f	-	93	-	mJ
Turn-on switching loss	E_{on}		-	1.20	-		
Turn-off switching loss	E_{off}		-	0.76	-		
Total switching loss	E_{ts}		-	1.96	-		

DIODE CHARACTERISTIC

Forward voltage	$V_{GE} = 0\text{ V}, I_F = 40\text{ A}$ $V_{GE} = 0\text{ V}, I_F = 40\text{ A}, T_J = 175^{\circ}\text{C}$	V_F	1.50 -	2.20 2.40	2.90 -	V
Reverse recovery time	$T_J = 25^{\circ}\text{C}$ $I_F = 40\text{ A}, V_R = 200\text{ V}$ $di_F/dt = 200\text{ A}/\mu\text{s}$	t_{rr}	-	72	-	ns
Reverse recovery charge		Q_{rr}	-	275	-	nC
Reverse recovery current		I_{rrm}	-	6.7	-	A
Reverse recovery time	$T_J = 175^{\circ}\text{C}$ $I_F = 40\text{ A}, V_R = 400\text{ V}$ $di_F/dt = 200\text{ A}/\mu\text{s}$	t_{rr}	-	158	-	ns
Reverse recovery charge		Q_{rr}	-	980	-	nC
Reverse recovery current		I_{rrm}	-	8.5	-	A

Product parametric performance is indicated in the Electrical Characteristics for the listed test conditions, unless otherwise noted. Product performance may not be indicated by the Electrical Characteristics if operated under different conditions.

NGTB40N65FL2WG

TYPICAL CHARACTERISTICS

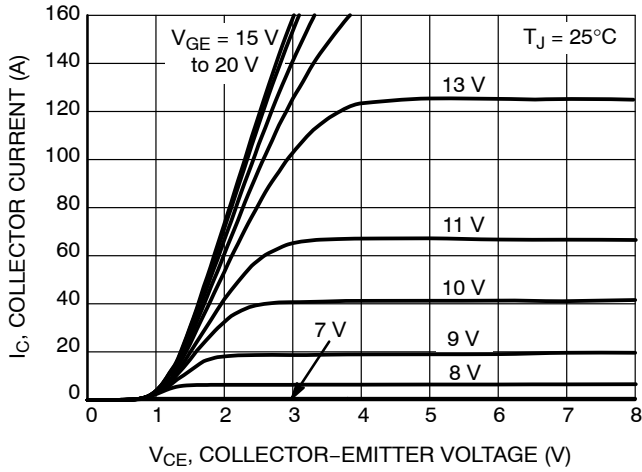

Figure 1. Output Characteristics

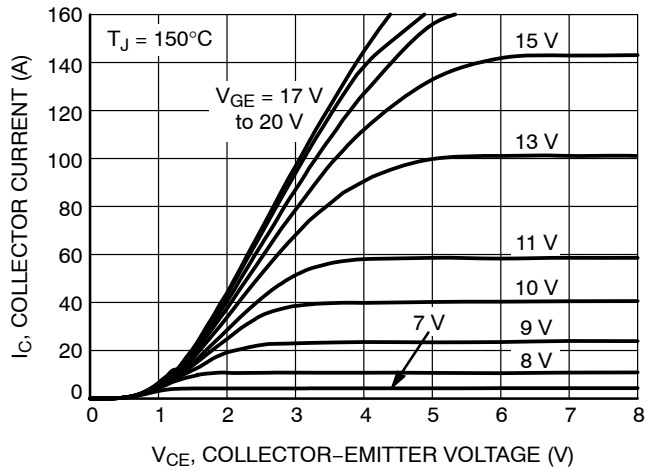

Figure 2. Output Characteristics

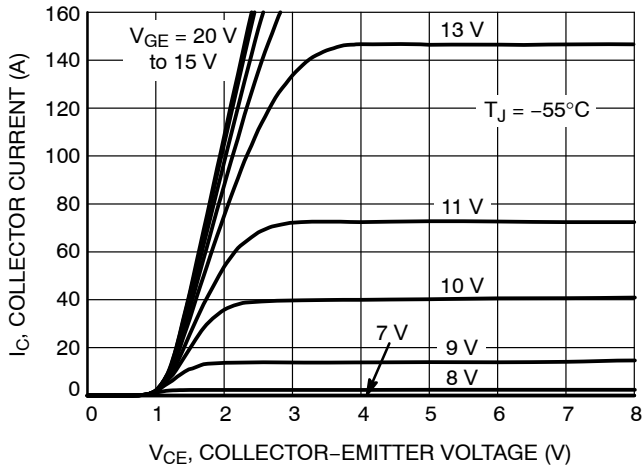

Figure 3. Output Characteristics

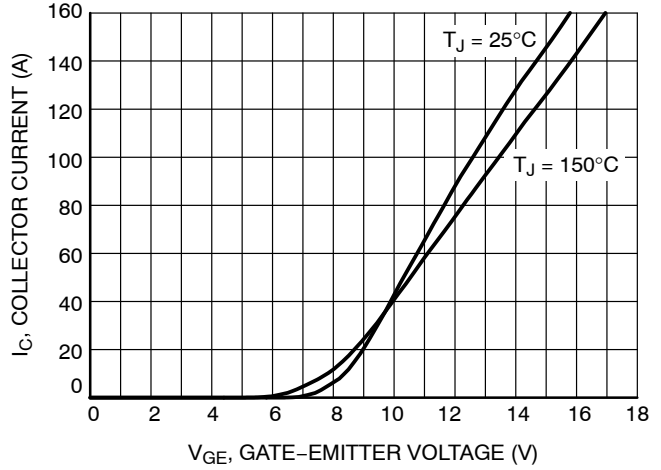

Figure 4. Typical Transfer Characteristics

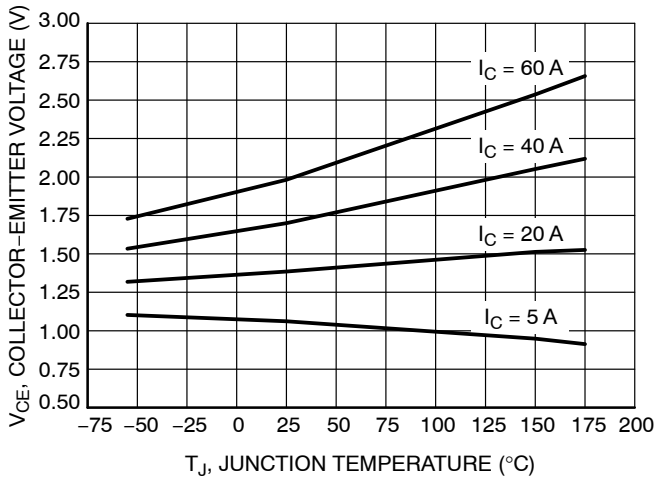

Figure 5. $V_{CE(sat)}$ vs. T_J

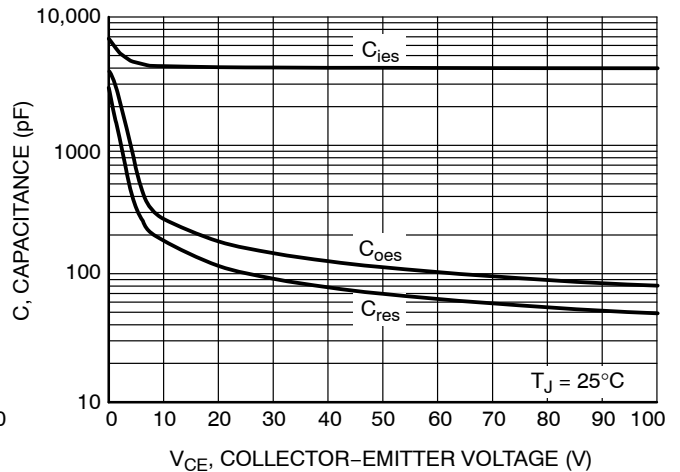

Figure 6. Typical Capacitance

NGTB40N65FL2WG

TYPICAL CHARACTERISTICS

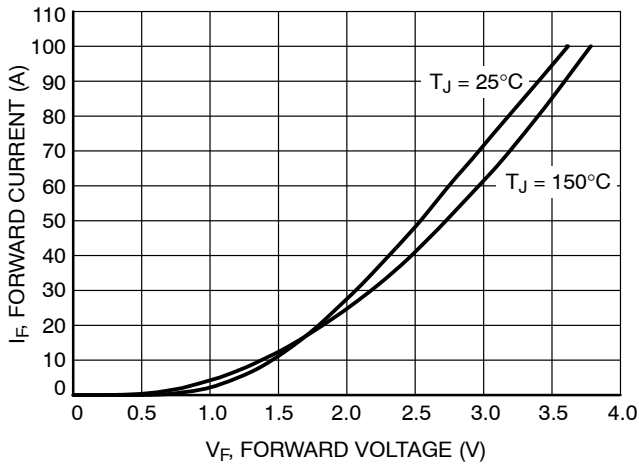

Figure 7. Diode Forward Characteristics

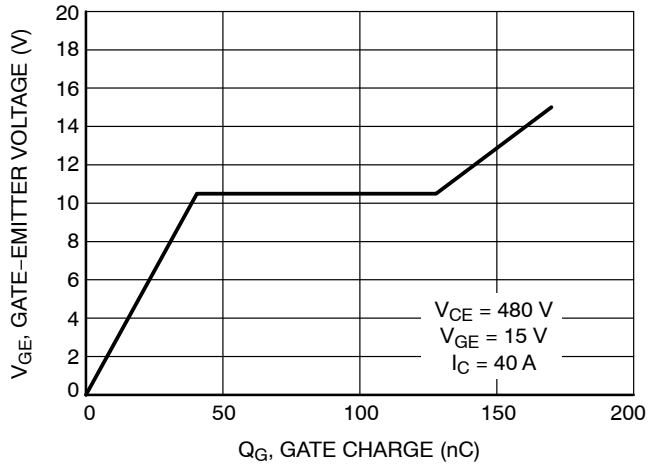

Figure 8. Typical Gate Charge

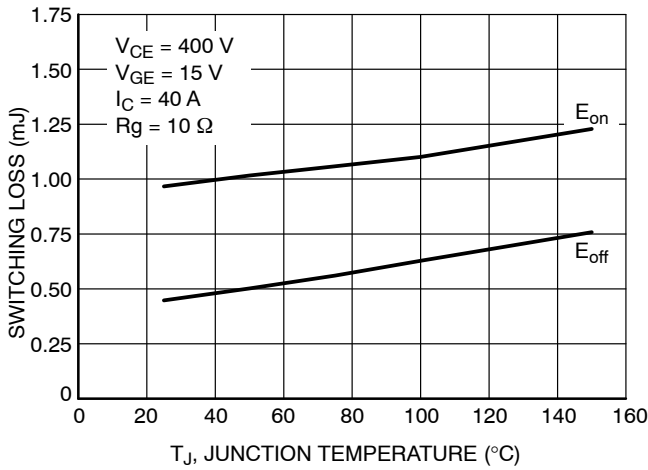

Figure 9. Switching Loss vs. Temperature

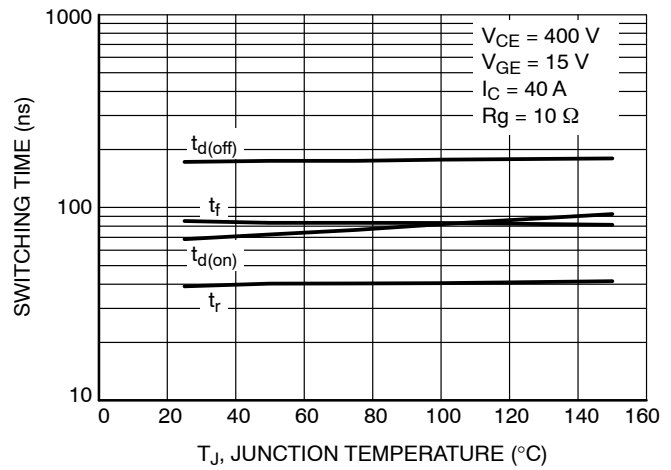

Figure 10. Switching Time vs. Temperature

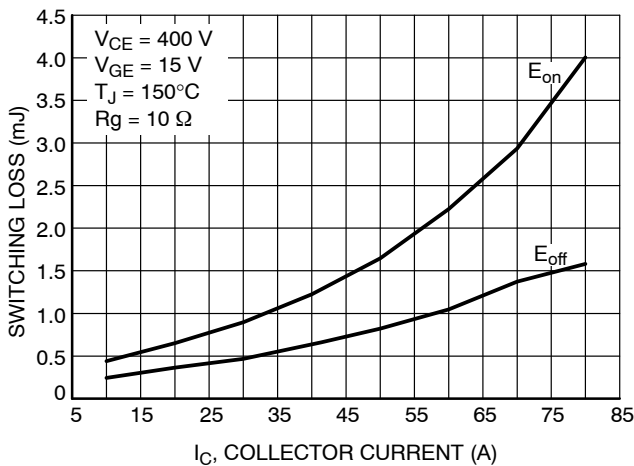

Figure 11. Switching Loss vs. I_C

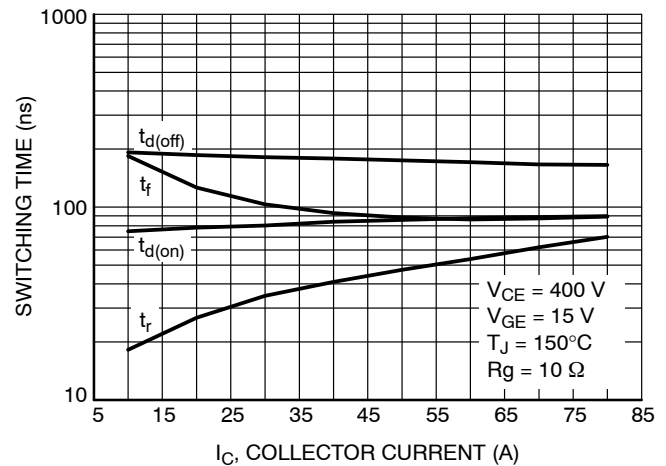

Figure 12. Switching Time vs. I_C

NGTB40N65FL2WG

TYPICAL CHARACTERISTICS

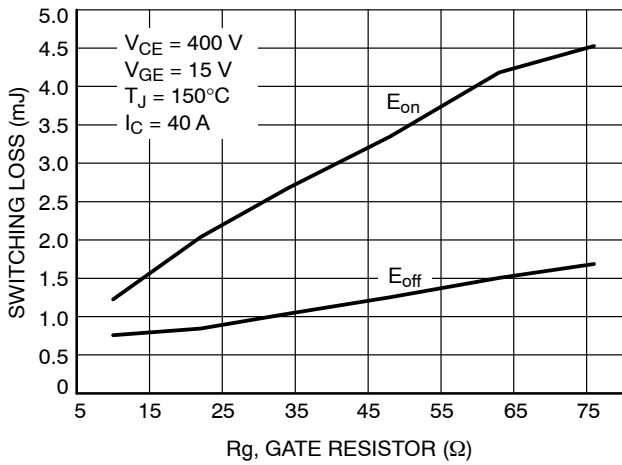

Figure 13. Switching Loss vs. R_g

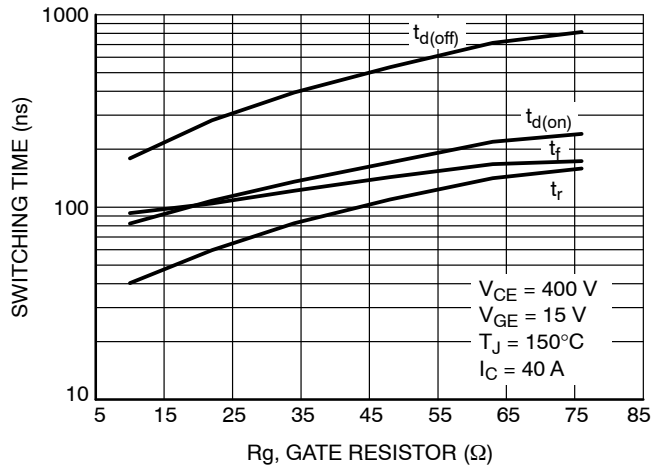

Figure 14. Switching Time vs. R_g

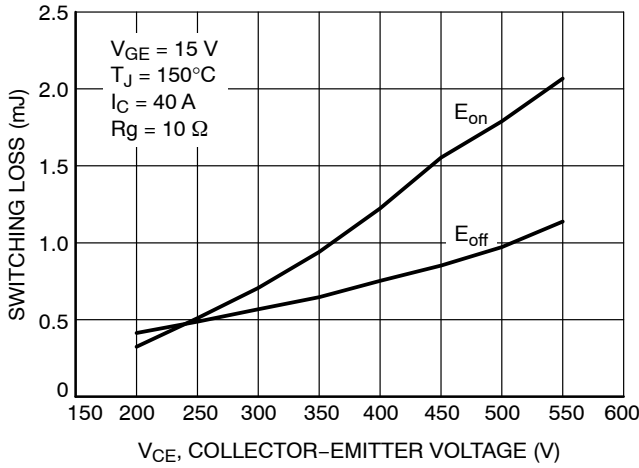

Figure 15. Switching Loss vs. V_{CE}

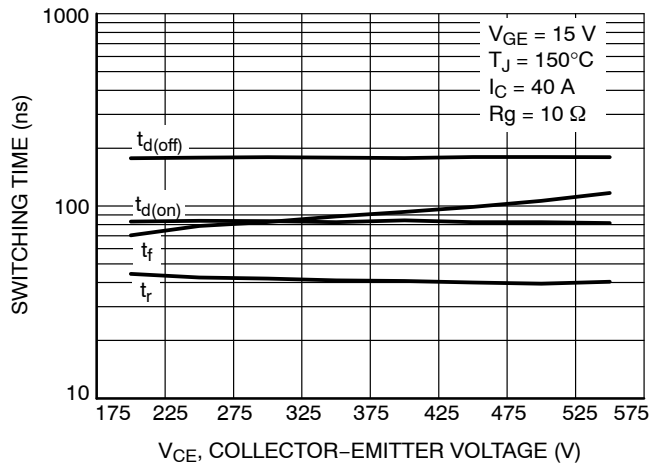

Figure 16. Switching Time vs. V_{CE}

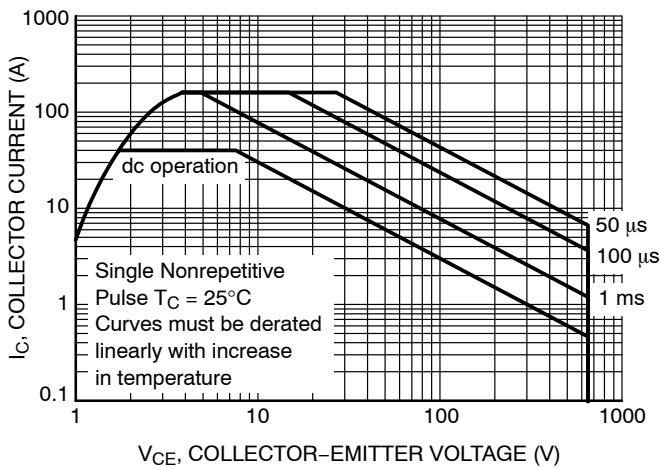

Figure 17. Safe Operating Area

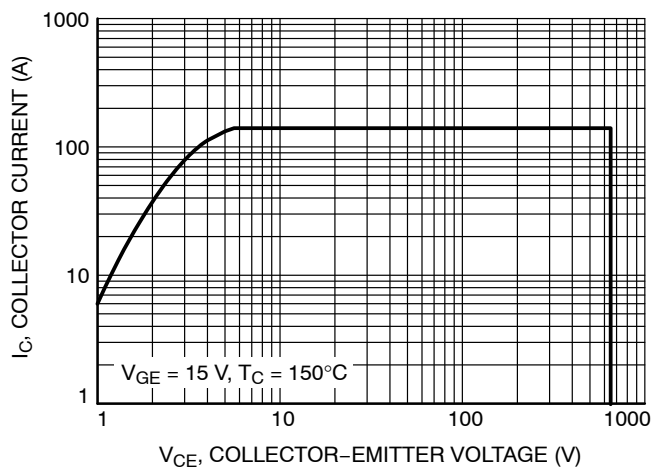

Figure 18. Reverse Bias Safe Operating Area

NGTB40N65FL2WG

TYPICAL CHARACTERISTICS

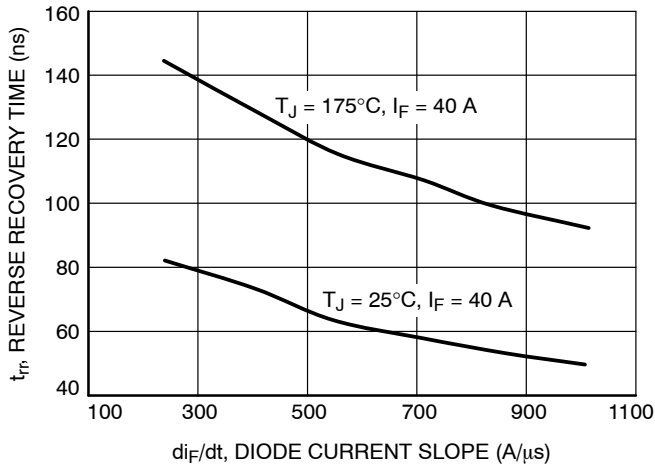

Figure 19. t_{rr} vs. di_F/dt
($V_R = 400 V$)

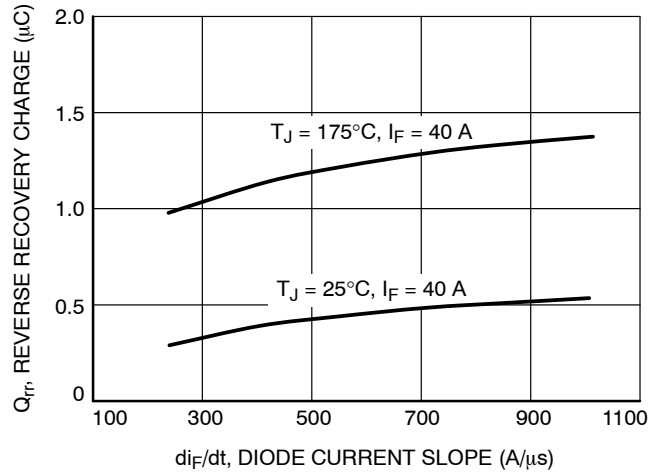

Figure 20. Q_{rr} vs. di_F/dt
($V_R = 400 V$)

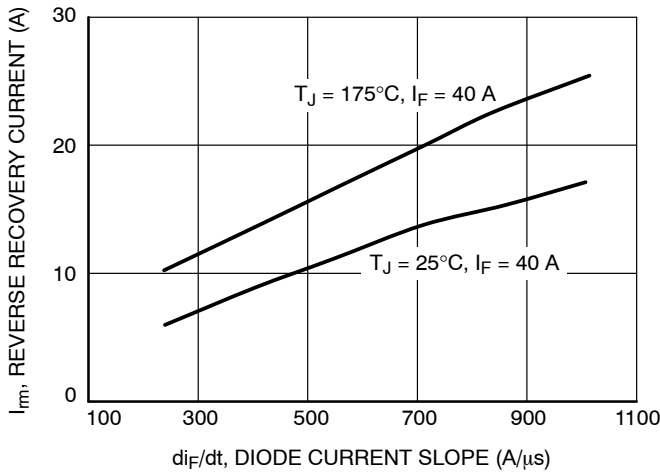

Figure 21. I_{rm} vs. di_F/dt
($V_R = 400 V$)

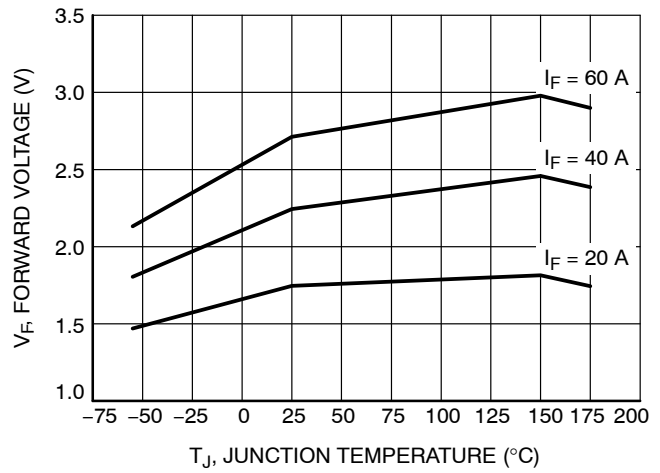

Figure 22. V_F vs. T_J

NGTB40N65FL2WG

TYPICAL CHARACTERISTICS

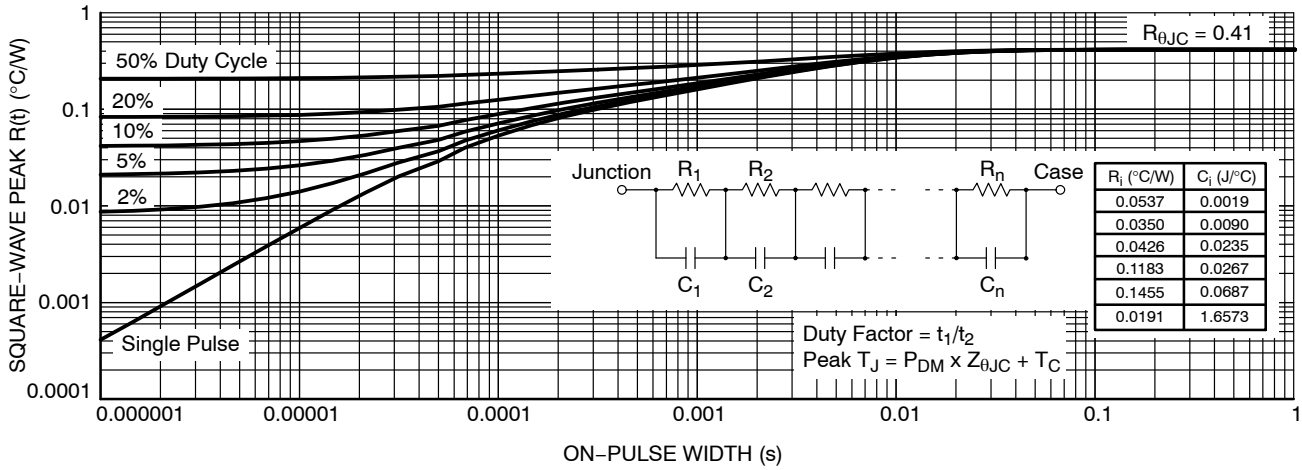

Figure 23. IGBT Transient Thermal Impedance

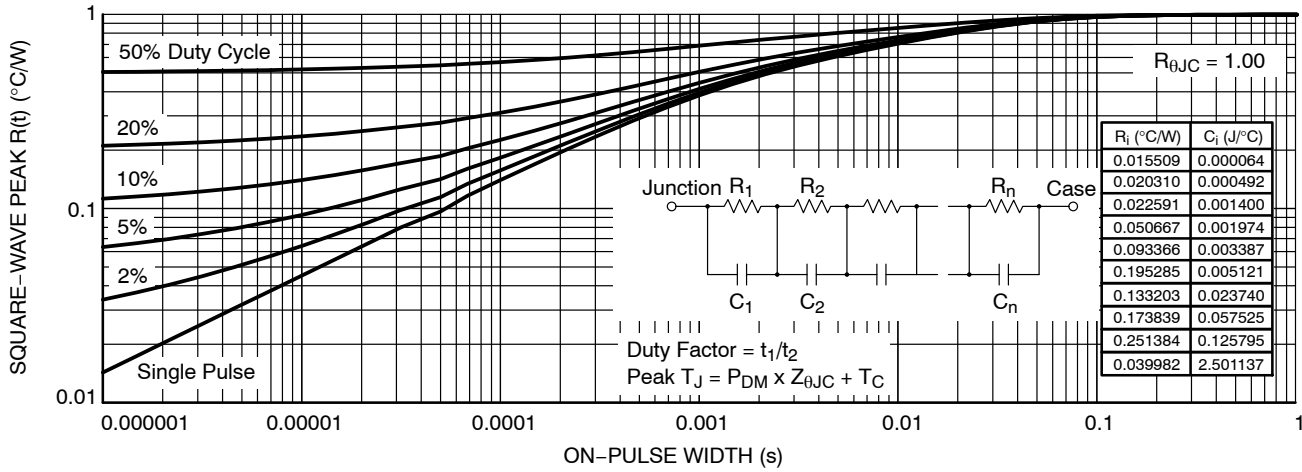

Figure 24. Diode Transient Thermal Impedance

NGTB40N65FL2WG

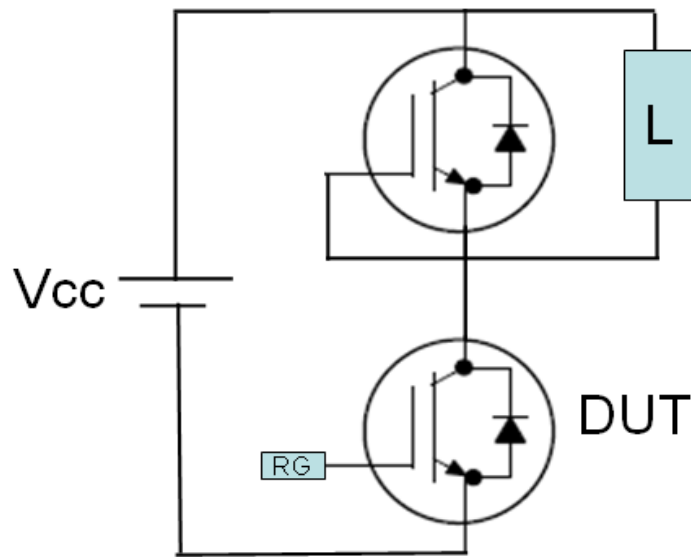

Figure 25. Test Circuit for Switching Characteristics

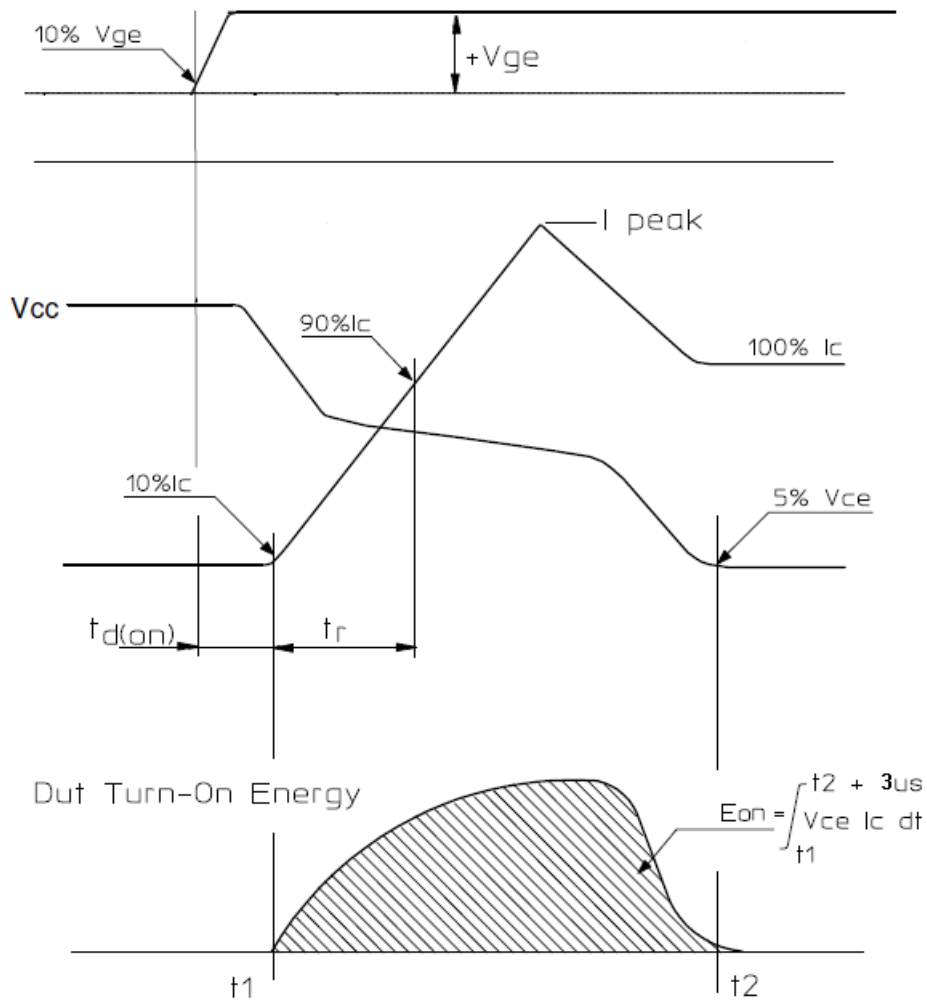

Figure 26. Definition of Turn On Waveform



Figure 27. Definition of Turn Off Waveform

MECHANICAL CASE OUTLINE PACKAGE DIMENSIONS

ON Semiconductor®

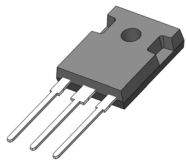

TO-247
CASE 340AM
ISSUE C

DATE 07 SEP 2021

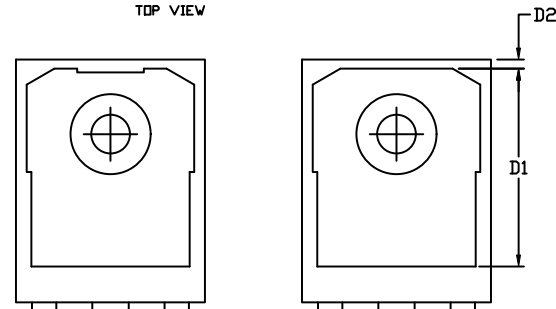
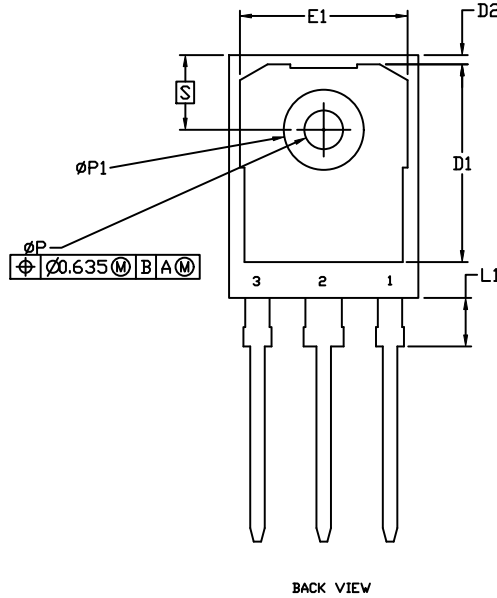
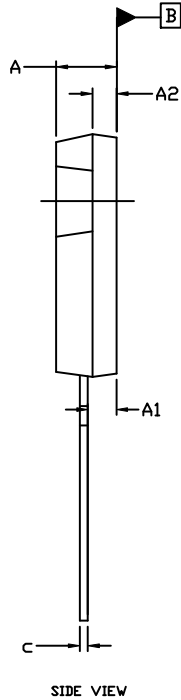
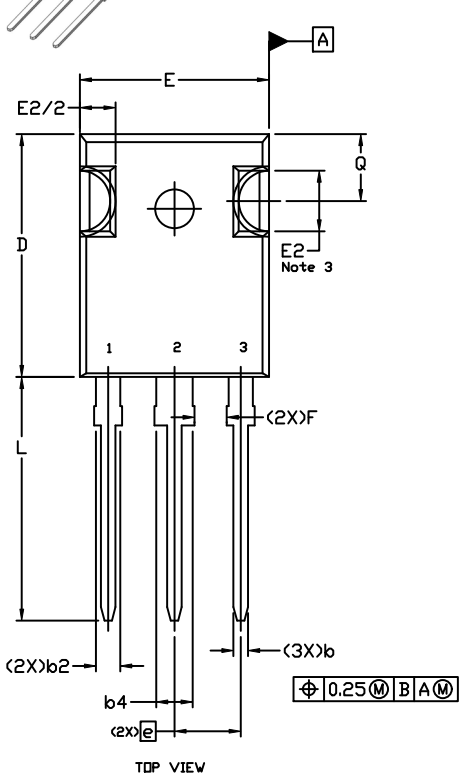

NOTE 4 HEATSINK SHAPES

NOTES:

1. DIMENSIONING AND TOLERANCE AS PER ASME Y14.5M, 2009.
2. ALL DIMENSION ARE IN MILLIMETERS.
3. SLOT REQUIRED, NOTCH MAY BE ROUNDED.
4. OPTIONAL BACK SIDE HEATSINK SHAPE.
5. DIMENSIONS ARE EXCLUSIVE OF BURRS AND MOLD FLASH. DIMENSIONS D AND E ARE MEASURED AT THE OUTERMOST EXTREME OF THE PLASTIC BODY.
6. DIMENSIONS A1 TO BE MEASURED IN THE REGION DEFINED BY L1.
7. LEAD FINISH IS UNCONTROLLED IN THE REGION DEFINED BY L1.

DIM	MILLIMETERS		
	MIN	NOM	MAX
A	4.70	5.00	5.30
A1	2.20	2.40	2.60
A2	1.80	2.00	2.20
b	1.07	1.20	1.33
b2	1.65	2.12	2.35
b4	2.60	3.12	3.40
c	0.45	0.60	0.75
D	20.80	21.00	21.34
D1	16.30	---	---
D2	0.75	---	---
E	15.50	16.00	16.25
E1	13.80	---	---
E2	4.32	4.90	5.49
e	5.45 BSC		
F	2.655	---	---
L	19.80	20.00	20.80
L1	3.81	4.20	4.35
P	3.55	3.60	3.65
P1	6.60	---	---
Q	5.40	6.00	6.20
S	6.15 BSC		

GENERIC MARKING DIAGRAMS*

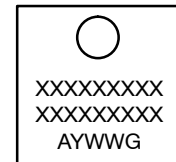
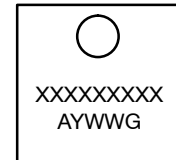

XXXX = Specific Device Code
 A = Assembly Location
 Y = Year
 WW = Work Week
 G = Pb-Free Package

*This information is generic. Please refer to device data sheet for actual part marking. Pb-Free indicator, "G" or microdot "•", may or may not be present. Some products may not follow the Generic Marking.

DOCUMENT NUMBER:	98AON77284F	Electronic versions are uncontrolled except when accessed directly from the Document Repository. Printed versions are uncontrolled except when stamped "CONTROLLED COPY" in red.
DESCRIPTION:	TO-247	PAGE 1 OF 1

ON Semiconductor and ON are trademarks of Semiconductor Components Industries, LLC dba ON Semiconductor or its subsidiaries in the United States and/or other countries. ON Semiconductor reserves the right to make changes without further notice to any products herein. ON Semiconductor makes no warranty, representation or guarantee regarding the suitability of its products for any particular purpose, nor does ON Semiconductor assume any liability arising out of the application or use of any product or circuit, and specifically disclaims any and all liability, including without limitation special, consequential or incidental damages. ON Semiconductor does not convey any license under its patent rights nor the rights of others.

onsemi, **Onsemi**, and other names, marks, and brands are registered and/or common law trademarks of Semiconductor Components Industries, LLC dba "**onsemi**" or its affiliates and/or subsidiaries in the United States and/or other countries. **onsemi** owns the rights to a number of patents, trademarks, copyrights, trade secrets, and other intellectual property. A listing of **onsemi**'s product/patent coverage may be accessed at www.onsemi.com/site/pdf/Patent-Marking.pdf. **onsemi** reserves the right to make changes at any time to any products or information herein, without notice. The information herein is provided "as-is" and **onsemi** makes no warranty, representation or guarantee regarding the accuracy of the information, product features, availability, functionality, or suitability of its products for any particular purpose, nor does **onsemi** assume any liability arising out of the application or use of any product or circuit, and specifically disclaims any and all liability, including without limitation special, consequential or incidental damages. Buyer is responsible for its products and applications using **onsemi** products, including compliance with all laws, regulations and safety requirements or standards, regardless of any support or applications information provided by **onsemi**. "Typical" parameters which may be provided in **onsemi** data sheets and/or specifications can and do vary in different applications and actual performance may vary over time. All operating parameters, including "Typicals" must be validated for each customer application by customer's technical experts. **onsemi** does not convey any license under any of its intellectual property rights nor the rights of others. **onsemi** products are not designed, intended, or authorized for use as a critical component in life support systems or any FDA Class 3 medical devices or medical devices with a same or similar classification in a foreign jurisdiction or any devices intended for implantation in the human body. Should Buyer purchase or use **onsemi** products for any such unintended or unauthorized application, Buyer shall indemnify and hold **onsemi** and its officers, employees, subsidiaries, affiliates, and distributors harmless against all claims, costs, damages, and expenses, and reasonable attorney fees arising out of, directly or indirectly, any claim of personal injury or death associated with such unintended or unauthorized use, even if such claim alleges that **onsemi** was negligent regarding the design or manufacture of the part. **onsemi** is an Equal Opportunity/Affirmative Action Employer. This literature is subject to all applicable copyright laws and is not for resale in any manner.

ADDITIONAL INFORMATION

TECHNICAL PUBLICATIONS:

Technical Library: www.onsemi.com/design/resources/technical-documentation
onsemi Website: www.onsemi.com

ONLINE SUPPORT: www.onsemi.com/support

For additional information, please contact your local Sales Representative at www.onsemi.com/support/sales

