

NST3904DP6T5G

Dual General Purpose Transistor

The NST3904DP6T5G device is a spin-off of our popular SOT-23/SOT-323/SOT-563 three-lead device. It is designed for general purpose amplifier applications and is housed in the SOT-963 six-lead surface mount package. By putting two discrete devices in one package, this device is ideal for low-power surface mount applications where board space is at a premium.

Features

- h_{FE} , 100–300
- Low $V_{CE(sat)}$, ≤ 0.4 V
- Reduces Board Space and Component Count
- NSV Prefix for Automotive and Other Applications Requiring Unique Site and Control Change Requirements; AEC-Q101 Qualified and PPAP Capable
- These Devices are Pb-Free, Halogen Free and are RoHS Compliant

MAXIMUM RATINGS

Rating	Symbol	Value	Unit
Collector – Emitter Voltage	V_{CEO}	40	Vdc
Collector – Base Voltage	V_{CBO}	60	Vdc
Emitter – Base Voltage	V_{EBO}	6.0	Vdc
Collector Current – Continuous	I_C	200	mAdc
Electrostatic Discharge	HBM MM	ESD Class 2 B	

THERMAL CHARACTERISTICS

Characteristic (Single Heated)	Symbol	Max	Unit
Total Device Dissipation $T_A = 25^\circ\text{C}$ Derate above 25°C (Note 1)	P_D	240 1.9	mW mW/ $^\circ\text{C}$
Thermal Resistance, Junction-to-Ambient (Note 1)	$R_{\theta JA}$	520	$^\circ\text{C}/\text{W}$
Total Device Dissipation $T_A = 25^\circ\text{C}$ Derate above 25°C (Note 2)	P_D	280 2.2	mW mW/ $^\circ\text{C}$
Thermal Resistance, Junction-to-Ambient (Note 2)	$R_{\theta JA}$	446	$^\circ\text{C}/\text{W}$
Characteristic (Dual Heated) (Note 3)	Symbol	Max	Unit
Total Device Dissipation $T_A = 25^\circ\text{C}$ Derate above 25°C (Note 1)	P_D	350 2.8	mW mW/ $^\circ\text{C}$
Thermal Resistance, Junction-to-Ambient (Note 1)	$R_{\theta JA}$	357	$^\circ\text{C}/\text{W}$
Total Device Dissipation $T_A = 25^\circ\text{C}$ Derate above 25°C (Note 2)	P_D	420 3.4	mW mW/ $^\circ\text{C}$
Thermal Resistance, Junction-to-Ambient (Note 2)	$R_{\theta JA}$	297	$^\circ\text{C}/\text{W}$
Junction and Storage Temperature Range	T_J, T_{stg}	-55 to +150	$^\circ\text{C}$

Stresses exceeding those listed in the Maximum Ratings table may damage the device. If any of these limits are exceeded, device functionality should not be assumed, damage may occur and reliability may be affected.

1. FR-4 @ 100 mm², 1 oz. copper traces, still air.
2. FR-4 @ 500 mm², 1 oz. copper traces, still air.
3. Dual heated values assume total power is sum of two equally powered channels.



ON Semiconductor®

www.onsemi.com

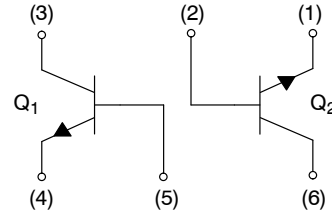

NST3904DP6T5G

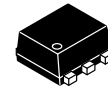

SOT-963
CASE 527AD

MARKING DIAGRAM

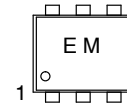

E = Device Code
M = Date Code

ORDERING INFORMATION

Device	Package	Shipping†
NST3904DP6T5G	SOT-963 (Pb-Free)	8000/Tape & Reel
NSVT3904DP6T5G	SOT-963 (Pb-Free)	8000/Tape & Reel

†For information on tape and reel specifications, including part orientation and tape sizes, please refer to our Tape and Reel Packaging Specifications Brochure, BRD8011/D.

NST3904DP6T5G

ELECTRICAL CHARACTERISTICS (T_A = 25°C unless otherwise noted)

Characteristic	Symbol	Min	Max	Unit
----------------	--------	-----	-----	------

OFF CHARACTERISTICS

Collector – Emitter Breakdown Voltage (Note 4) (I _C = 1.0 mAdc, I _B = 0)	V _{(BR)CEO}	40	–	Vdc
Collector – Base Breakdown Voltage (I _C = 10 μAdc, I _E = 0)	V _{(BR)CBO}	60	–	Vdc
Emitter – Base Breakdown Voltage (I _E = 10 μAdc, I _C = 0)	V _{(BR)EBO}	6.0	–	Vdc
Collector Cutoff Current (V _{CE} = 30 Vdc, V _{EB} = 3.0 Vdc)	I _{CEx}	–	50	nAdc

ON CHARACTERISTICS (Note 4)

DC Current Gain (I _C = 0.1 mAdc, V _{CE} = 1.0 Vdc) (I _C = 1.0 mAdc, V _{CE} = 1.0 Vdc) (I _C = 10 mAdc, V _{CE} = 1.0 Vdc) (I _C = 50 mAdc, V _{CE} = 1.0 Vdc) (I _C = 100 mAdc, V _{CE} = 1.0 Vdc)	h _{FE}	40 70 100 60 30	– – 300 – –	–
Collector – Emitter Saturation Voltage (I _C = 10 mAdc, I _B = 1.0 mAdc) (I _C = 50 mAdc, I _B = 5.0 mAdc)	V _{CE(sat)}	– –	0.2 0.3	Vdc
Base – Emitter Saturation Voltage (I _C = 10 mAdc, I _B = 1.0 mAdc) (I _C = 50 mAdc, I _B = 5.0 mAdc)	V _{BE(sat)}	0.65 –	0.85 0.95	Vdc

SMALL-SIGNAL CHARACTERISTICS

Current – Gain – Bandwidth Product (I _C = 10 mAdc, V _{CE} = 20 Vdc, f = 100 MHz)	f _T	200	–	MHz
Output Capacitance (V _{CB} = 5.0 Vdc, I _E = 0, f = 1.0 MHz)	C _{obo}	–	4.0	pF
Input Capacitance (V _{EB} = 0.5 Vdc, I _C = 0, f = 1.0 MHz)	C _{ibo}	–	8.0	pF
Noise Figure (V _{CE} = 5.0 Vdc, I _C = 100 μAdc, R _S = 1.0 kΩ, f = 1.0 kHz)	NF	–	5.0	dB

SWITCHING CHARACTERISTICS

Delay Time	(V _{CC} = 3.0 Vdc, V _{BE} = –0.5 Vdc)	t _d	–	35	ns
Rise Time	(I _C = 10 mAdc, I _{B1} = 1.0 mAdc)	t _r	–	35	
Storage Time	(V _{CC} = 3.0 Vdc, I _C = 10 mAdc)	t _s	–	275	ns
Fall Time	(I _{B1} = I _{B2} = 1.0 mAdc)	t _f	–	50	

4. Pulse Test: Pulse Width ≤ 300 μs; Duty Cycle ≤ 2.0%.

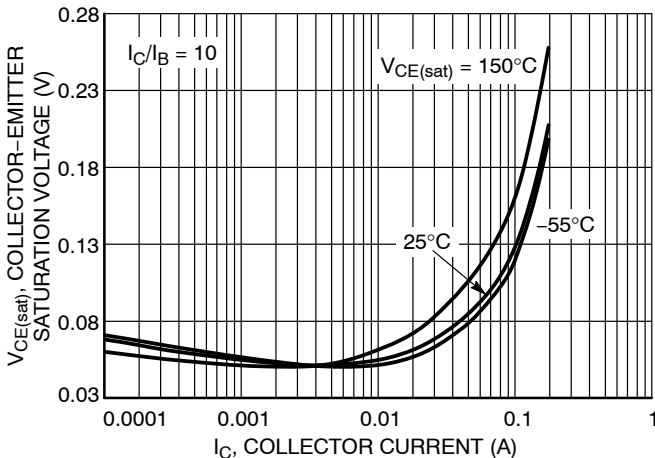

Figure 1. Collector Emitter Saturation Voltage vs. Collector Current

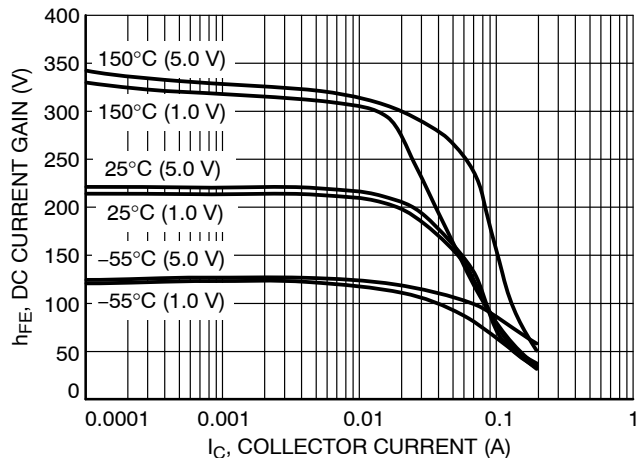

Figure 2. DC Current Gain vs. Collector Current

NST3904DP6T5G

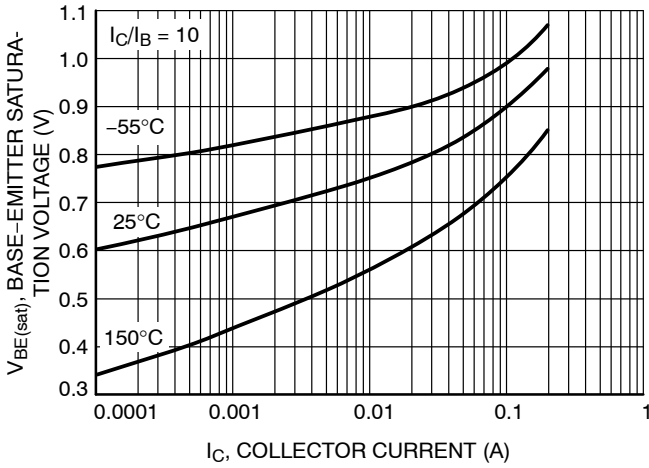

Figure 3. Base Emitter Saturation Voltage vs. Collector Current

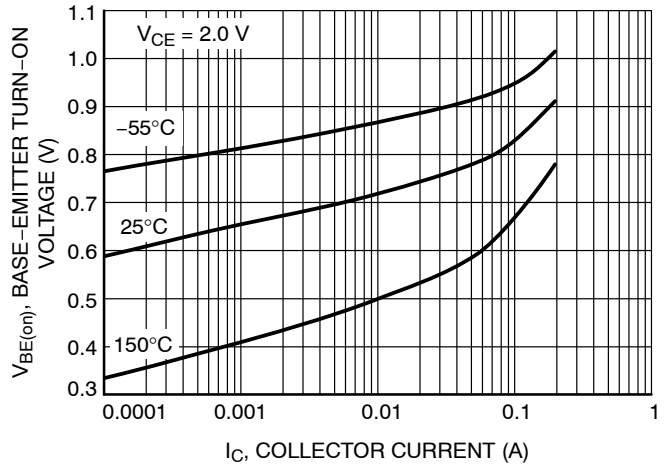

Figure 4. Base Emitter Turn-On Voltage vs. Collector Current

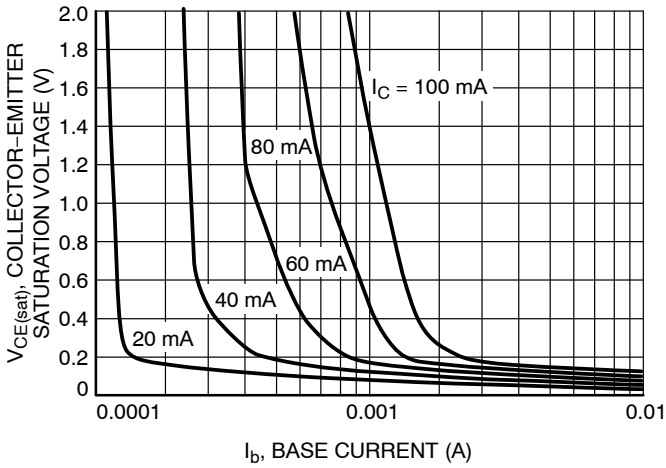

Figure 5. Saturation Region

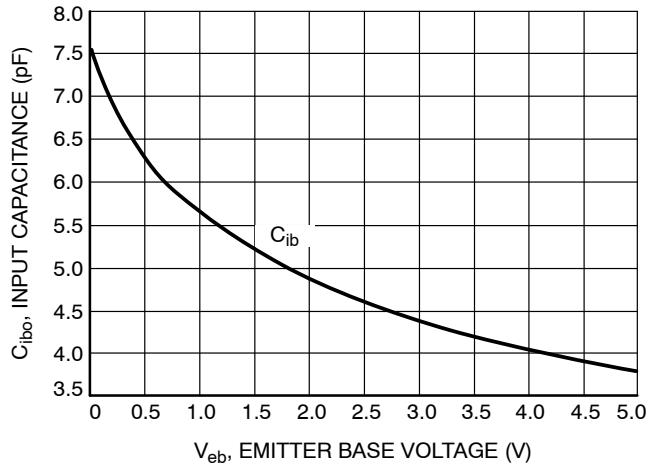

Figure 6. Input Capacitance

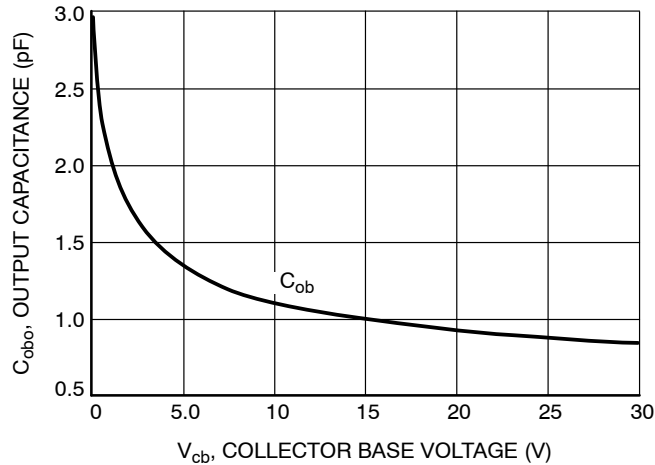
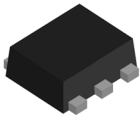

Figure 7. Output Capacitance

MECHANICAL CASE OUTLINE

PACKAGE DIMENSIONS



SOT-963 1.00x1.00x0.37, 0.35P
CASE 527AD
ISSUE F

DATE 20 FEB 2024

NOTES:

1. DIMENSIONING AND TOLERANCING PER ASME Y14.5M, 2018.
2. CONTROLLING DIMENSION: MILLIMETERS.
3. MAXIMUM LEAD THICKNESS INCLUDES LEAD FINISH THICKNESS. MINIMUM LEAD THICKNESS IS THE MINIMUM THICKNESS OF BASE MATERIAL.
4. DIMENSIONS D AND E DO NOT INCLUDE MOLD FLASH, PROTRUSIONS, OR GATE BURRS.

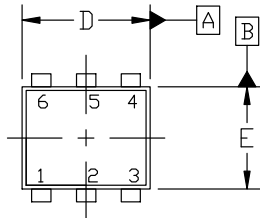

TOP VIEW

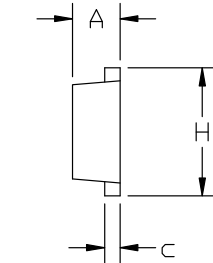

SIDE VIEW

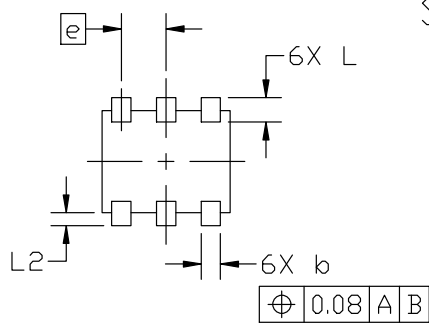

BOTTOM VIEW

DIM	MILLIMETERS		
	MIN.	NOM.	MAX.
A	0.34	0.37	0.40
b	0.10	0.15	0.20
c	0.07	0.12	0.17
D	0.95	1.00	1.05
E	0.75	0.80	0.85
e	0.35 BSC		
H	0.95	1.00	1.05
L	0.19 REF		
L2	0.05	0.10	0.15

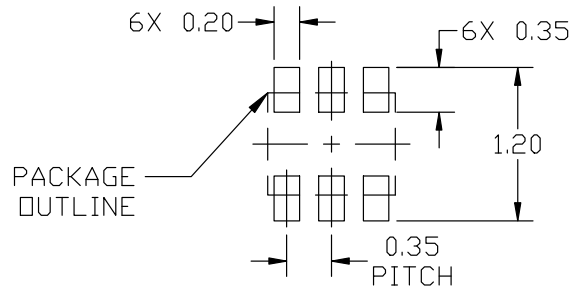

RECOMMENDED MOUNTING FOOTPRINT

*For additional information on our Pb-Free strategy and soldering details, please download the ON Semiconductor Soldering and Mounting Techniques Reference manual, SOLDERRM/D.

STYLE 1:

- PIN 1. EMITTER 1
- 2. BASE 1
- 3. COLLECTOR 2
- 4. EMITTER 2
- 5. BASE 2
- 6. COLLECTOR 1

STYLE 2:

- PIN 1. EMITTER 1
- 2. EMITTER2
- 3. BASE 2
- 4. COLLECTOR 2
- 5. BASE 1
- 6. COLLECTOR 1

STYLE 3:

- PIN 1. CATHODE 1
- 2. CATHODE 1
- 3. ANODE/ANODE 2
- 4. CATHODE 2
- 5. CATHODE 2
- 6. ANODE/ANODE 1

STYLE 4:

- PIN 1. COLLECTOR
- 2. COLLECTOR
- 3. BASE
- 4. EMITTER
- 5. COLLECTOR
- 6. COLLECTOR

STYLE 5:

- PIN 1. CATHODE
- 2. CATHODE
- 3. ANODE
- 4. ANODE
- 5. CATHODE
- 6. CATHODE

STYLE 6:

- PIN 1. CATHODE
- 2. ANODE
- 3. CATHODE
- 4. CATHODE
- 5. CATHODE
- 6. CATHODE

STYLE 7:

- PIN 1. CATHODE
- 2. ANODE
- 3. CATHODE
- 4. CATHODE
- 5. ANODE
- 6. CATHODE

STYLE 8:

- PIN 1. DRAIN
- 2. DRAIN
- 3. GATE
- 4. SOURCE
- 5. DRAIN
- 6. DRAIN

STYLE 9:

- PIN 1. SOURCE 1
- 2. GATE 1
- 3. DRAIN 2
- 4. SOURCE 2
- 5. GATE 2
- 6. DRAIN 1

STYLE 10:

- PIN 1. CATHODE 1
- 2. N/C
- 3. CATHODE 2
- 4. ANODE 2
- 5. N/C
- 6. ANODE 1

GENERIC MARKING DIAGRAM*

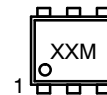

XX = Specific Device Code
M = Month Code

*This information is generic. Please refer to device data sheet for actual part marking. Pb-Free indicator, "G" or microdot "•", may or may not be present. Some products may not follow the Generic Marking.

DOCUMENT NUMBER:	98AON26456D	Electronic versions are uncontrolled except when accessed directly from the Document Repository. Printed versions are uncontrolled except when stamped "CONTROLLED COPY" in red.
DESCRIPTION:	SOT-963 1.00x1.00x0.37, 0.35P	PAGE 1 OF 1

onsemi and ONSEMI are trademarks of Semiconductor Components Industries, LLC dba onsemi or its subsidiaries in the United States and/or other countries. onsemi reserves the right to make changes without further notice to any products herein. onsemi makes no warranty, representation or guarantee regarding the suitability of its products for any particular purpose, nor does onsemi assume any liability arising out of the application or use of any product or circuit, and specifically disclaims any and all liability, including without limitation special, consequential or incidental damages. onsemi does not convey any license under its patent rights nor the rights of others.

onsemi, **Onsemi**, and other names, marks, and brands are registered and/or common law trademarks of Semiconductor Components Industries, LLC dba "**onsemi**" or its affiliates and/or subsidiaries in the United States and/or other countries. **onsemi** owns the rights to a number of patents, trademarks, copyrights, trade secrets, and other intellectual property. A listing of **onsemi**'s product/patent coverage may be accessed at www.onsemi.com/site/pdf/Patent-Marking.pdf. **onsemi** reserves the right to make changes at any time to any products or information herein, without notice. The information herein is provided "as-is" and **onsemi** makes no warranty, representation or guarantee regarding the accuracy of the information, product features, availability, functionality, or suitability of its products for any particular purpose, nor does **onsemi** assume any liability arising out of the application or use of any product or circuit, and specifically disclaims any and all liability, including without limitation special, consequential or incidental damages. Buyer is responsible for its products and applications using **onsemi** products, including compliance with all laws, regulations and safety requirements or standards, regardless of any support or applications information provided by **onsemi**. "Typical" parameters which may be provided in **onsemi** data sheets and/or specifications can and do vary in different applications and actual performance may vary over time. All operating parameters, including "Typicals" must be validated for each customer application by customer's technical experts. **onsemi** does not convey any license under any of its intellectual property rights nor the rights of others. **onsemi** products are not designed, intended, or authorized for use as a critical component in life support systems or any FDA Class 3 medical devices or medical devices with a same or similar classification in a foreign jurisdiction or any devices intended for implantation in the human body. Should Buyer purchase or use **onsemi** products for any such unintended or unauthorized application, Buyer shall indemnify and hold **onsemi** and its officers, employees, subsidiaries, affiliates, and distributors harmless against all claims, costs, damages, and expenses, and reasonable attorney fees arising out of, directly or indirectly, any claim of personal injury or death associated with such unintended or unauthorized use, even if such claim alleges that **onsemi** was negligent regarding the design or manufacture of the part. **onsemi** is an Equal Opportunity/Affirmative Action Employer. This literature is subject to all applicable copyright laws and is not for resale in any manner.

ADDITIONAL INFORMATION

TECHNICAL PUBLICATIONS:

Technical Library: www.onsemi.com/design/resources/technical-documentation
onsemi Website: www.onsemi.com

ONLINE SUPPORT: www.onsemi.com/support

For additional information, please contact your local Sales Representative at www.onsemi.com/support/sales