

MOSFET – Power, P-Channel, Schottky Diode, μ Cool 2x2 mm -20 V, -4.1 A, 2.0 A



ON Semiconductor®

www.onsemi.com

NTLJF3117P

Features

- FETKY™ Configuration with MOSFET plus Low Vf Schottky Diode
- μ COOL™ Package Provides Exposed Drain Pad for Excellent Thermal Conduction
- 2x2 mm Footprint Same as SC-88 Package Design
- Independent Pinout Provides Circuit Design Flexibility
- Low Profile (< 0.8 mm) for Easy Fit in Thin Environment
- High Current Schottky Diode: 2 A Current Rating
- This is a Pb-Free Device

Applications

- Optimized for Portable Applications like Cell Phones, Digital Cameras, Media Players, etc.
- DC-DC Buck Circuit
- Li-Ion Battery Applications
- Color Display and Camera Flash Regulators

MAXIMUM RATINGS ($T_J = 25^\circ\text{C}$ unless otherwise noted)

Parameter		Symbol	Value	Unit	
Drain-to-Source Voltage		V_{DSS}	-20	V	
Gate-to-Source Voltage		V_{GS}	± 8.0	V	
Continuous Drain Current (Note 1)	Steady State	I_D	$T_A = 25^\circ\text{C}$	-3.3	A
			$T_A = 85^\circ\text{C}$	-2.4	
	$t \leq 5$ s	$T_A = 25^\circ\text{C}$	-4.1		
Power Dissipation (Note 1)	Steady State	P_D	$T_A = 25^\circ\text{C}$	1.5	W
			$t \leq 5$ s	2.3	
Continuous Drain Current (Note 2)	Steady State	I_D	$T_A = 25^\circ\text{C}$	-2.3	A
			$T_A = 85^\circ\text{C}$	-1.6	
			$T_A = 25^\circ\text{C}$	0.71	
Power Dissipation (Note 2)		P_D	0.71	W	
Pulsed Drain Current	$t_p = 10$ μ s	I_{DM}	-20	A	
Operating Junction and Storage Temperature		T_J, T_{STG}	-55 to 150	$^\circ\text{C}$	
Source Current (Body Diode) (Note 2)		I_S	-1.9	A	
Lead Temperature for Soldering Purposes (1/8" from case for 10 s)		T_L	260	$^\circ\text{C}$	

Stresses exceeding those listed in the Maximum Ratings table may damage the device. If any of these limits are exceeded, device functionality should not be assumed, damage may occur and reliability may be affected.

1. Surface Mounted on FR4 Board using 1 in sq pad size (Cu area = 1.127 in sq [1 oz] including traces).
2. Surface Mounted on FR4 Board using the minimum recommended pad size of 30 mm², 2 oz Cu.

MOSFET

$V_{(BR)DSS}$	$R_{DS(on)}$ MAX	I_D MAX (Note 1)
-20 V	100 m Ω @ -4.5 V	-4.1 A
	135 m Ω @ -2.5 V	
	200 m Ω @ -1.8 V	

SCHOTTKY DIODE

V_R MAX	V_F TYP	I_F MAX
30 V	0.47 V	2.0 A

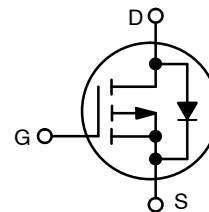

P-CHANNEL MOSFET



SCHOTTKY DIODE

MARKING DIAGRAM

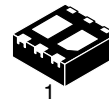

WDFN6
CASE 506AN



JH = Specific Device Code
M = Date Code
▪ = Pb-Free Package
(Note: Microdot may be in either location)

PIN CONNECTIONS

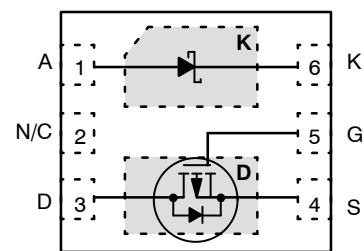

(Top View)

ORDERING INFORMATION

See detailed ordering and shipping information in the package dimensions section on page 7 of this data sheet.

NTLJF3117P

SCHOTTKY DIODE MAXIMUM RATINGS ($T_J = 25^\circ\text{C}$ unless otherwise noted)

Parameter	Symbol	Value	Unit
Peak Repetitive Reverse Voltage	V_{RRM}	30	V
DC Blocking Voltage	V_R	30	V
Average Rectified Forward Current	I_F	2.0	A

THERMAL RESISTANCE RATINGS

Parameter	Symbol	Max	Unit
Junction-to-Ambient – Steady State (Note 3)	$R_{\theta JA}$	83	$^\circ\text{C}/\text{W}$
Junction-to-Ambient – $t \leq 5$ s (Note 3)	$R_{\theta JA}$	54	
Junction-to-Ambient – Steady State Min Pad (Note 4)	$R_{\theta JA}$	177	

3. Surface Mounted on FR4 Board using 1 in sq pad size (Cu area = 1.127 in sq [2 oz] including traces).
 4. Surface Mounted on FR4 Board using the minimum recommended pad size of 30 mm², 2 oz Cu.

MOSFET ELECTRICAL CHARACTERISTICS ($T_J = 25^\circ\text{C}$ unless otherwise noted)

Parameter	Symbol	Test Conditions	Min	Typ	Max	Unit
-----------	--------	-----------------	-----	-----	-----	------

OFF CHARACTERISTICS

Drain-to-Source Breakdown Voltage	$V_{(BR)DSS}$	$V_{GS} = 0$ V, $I_D = -250$ μA	-20			V
Drain-to-Source Breakdown Voltage Temperature Coefficient	$V_{(BR)DSS}/T_J$	$I_D = -250$ μA , Ref to 25°C		9.95		$\text{mV}/^\circ\text{C}$
Zero Gate Voltage Drain Current	I_{DSS}	$V_{DS} = -16$ V, $V_{GS} = 0$ V	$T_J = 25^\circ\text{C}$		-1.0	μA
			$T_J = 85^\circ\text{C}$		-10	
Gate-to-Source Leakage Current	I_{GSS}	$V_{DS} = 0$ V, $V_{GS} = \pm 8.0$ V			± 100	nA

ON CHARACTERISTICS (Note 5)

Gate Threshold Voltage	$V_{GS(TH)}$	$V_{GS} = V_{DS}$, $I_D = -250$ μA	-0.4	-0.7	-1.0	V
Negative Threshold Temperature Coefficient	$V_{GS(TH)}/T_J$			2.44		$\text{mV}/^\circ\text{C}$
Drain-to-Source On-Resistance	$R_{DS(on)}$	$V_{GS} = -4.5$ V, $I_D = -2.0$ A		75	100	m Ω
		$V_{GS} = -2.5$ V, $I_D = -2.0$ A		101	135	
		$V_{GS} = -1.8$ V, $I_D = -1.6$ A		150	200	
Forward Transconductance	g_{FS}	$V_{DS} = -5.0$ V, $I_D = -2.0$ A		3.1		S

CHARGES, CAPACITANCES AND GATE RESISTANCE

Input Capacitance	C_{ISS}	$V_{GS} = 0$ V, $f = 1.0$ MHz, $V_{DS} = -10$ V		531		pF
Output Capacitance	C_{OSS}			91		
Reverse Transfer Capacitance	C_{RSS}			56		
Total Gate Charge	$Q_{G(TOT)}$	$V_{GS} = -4.5$ V, $V_{DS} = -10$ V, $I_D = -2.0$ A		5.5	6.2	nC
Threshold Gate Charge	$Q_{G(TH)}$			0.7		
Gate-to-Source Charge	Q_{GS}			1.0		
Gate-to-Drain Charge	Q_{GD}			1.4		
Gate Resistance	R_G			8.8		

SWITCHING CHARACTERISTICS (Note 6)

Turn-On Delay Time	$t_{d(ON)}$	$V_{GS} = -4.5$ V, $V_{DD} = -5.0$ V, $I_D = -1.0$ A, $R_G = 6.0$ Ω		5.2		ns
Rise Time	t_r			13.2		
Turn-Off Delay Time	$t_{d(OFF)}$			13.7		
Fall Time	t_f			19.1		

5. Pulse Test: Pulse Width ≤ 300 μs , Duty Cycle $\leq 2\%$.
 6. Switching characteristics are independent of operating junction temperatures.

NTLJF3117P

MOSFET ELECTRICAL CHARACTERISTICS ($T_J = 25^\circ\text{C}$ unless otherwise noted)

Parameter	Symbol	Test Conditions	Min	Typ	Max	Unit
SWITCHING CHARACTERISTICS (Note 6)						
Turn-On Delay Time	$t_{d(ON)}$	$V_{GS} = -4.5\text{ V}, V_{DD} = -10\text{ V},$ $I_D = -2.0\text{ A}, R_G = 2.0\ \Omega$		5.5		ns
Rise Time	t_r			15		
Turn-Off Delay Time	$t_{d(OFF)}$			19.8		
Fall Time	t_f			21.6		

DRAIN-SOURCE DIODE CHARACTERISTICS

Forward Recovery Voltage	V_{SD}	$V_{GS} = 0\text{ V}, I_S = -1.0\text{ A}$	$T_J = 25^\circ\text{C}$		-0.75	-1.0	V
			$T_J = 125^\circ\text{C}$		-0.64		
Reverse Recovery Time	t_{RR}	$V_{GS} = 0\text{ V}, d_{ISD}/d_t = 100\text{ A}/\mu\text{s},$ $I_S = -1.0\text{ A}$			16.2		ns
Charge Time	t_a				10.6		
Discharge Time	t_b				5.6		
Reverse Recovery Time	Q_{RR}				5.7		

5. Pulse Test: Pulse Width $\leq 300\ \mu\text{s}$, Duty Cycle $\leq 2\%$.

6. Switching characteristics are independent of operating junction temperatures.

SCHOTTKY DIODE ELECTRICAL CHARACTERISTICS ($T_J = 25^\circ\text{C}$ unless otherwise noted)

Parameter	Symbol	Test Conditions	Min	Typ	Max	Unit
Maximum Instantaneous Forward Voltage	V_F	$I_F = 0.1\text{ A}$		0.34	0.39	V
		$I_F = 1.0\text{ A}$		0.47	0.53	
Maximum Instantaneous Reverse Current	I_R	$V_R = 30\text{ V}$		17	20	μA
		$V_R = 20\text{ V}$		3.0	8.0	
		$V_R = 10\text{ V}$		2.0	4.5	

SCHOTTKY DIODE ELECTRICAL CHARACTERISTICS ($T_J = 85^\circ\text{C}$ unless otherwise noted)

Parameter	Symbol	Test Conditions	Min	Typ	Max	Unit
Maximum Instantaneous Forward Voltage	V_F	$I_F = 0.1\text{ A}$		0.22	0.35	V
		$I_F = 1.0\text{ A}$		0.40	0.50	
Maximum Instantaneous Reverse Current	I_R	$V_R = 30\text{ V}$		0.22	2.5	mA
		$V_R = 20\text{ V}$		0.11	1.6	
		$V_R = 10\text{ V}$		0.06	1.2	

SCHOTTKY DIODE ELECTRICAL CHARACTERISTICS ($T_J = 125^\circ\text{C}$ unless otherwise noted)

Parameter	Symbol	Test Conditions	Min	Typ	Max	Unit
Maximum Instantaneous Forward Voltage	V_F	$I_F = 0.1\text{ A}$		0.2	0.29	V
		$I_F = 1.0\text{ A}$		0.4	0.47	
Maximum Instantaneous Reverse Current	I_R	$V_R = 30\text{ V}$		2.0	20	mA
		$V_R = 20\text{ V}$		1.1	10.9	
		$V_R = 10\text{ V}$		0.63	8.4	

SCHOTTKY DIODE ELECTRICAL CHARACTERISTICS ($T_J = 25^\circ\text{C}$ unless otherwise noted)

Parameter	Symbol	Test Conditions	Min	Typ	Max	Unit
Capacitance	C	$V_R = 5.0\text{ V}, f = 1.0\text{ MHz}$		38		pF

7. Surface-mounted on FR4 board using 1 in sq pad size (Cu area = 1.127 in sq [2 oz] including traces).

8. Surface-mounted on FR4 board using the minimum recommended pad size of 30 mm², 2 oz cu.

9. Pulse Test: pulse width $\leq 300\ \mu\text{s}$, duty cycle $\leq 2\%$.

10. Switching characteristics are independent of operating junction temperatures.

TYPICAL PERFORMANCE CURVES ($T_J = 25^\circ\text{C}$ unless otherwise noted)

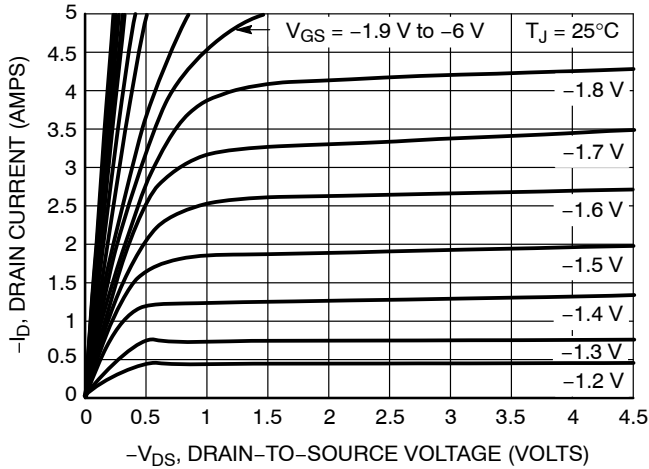

Figure 1. On-Region Characteristics

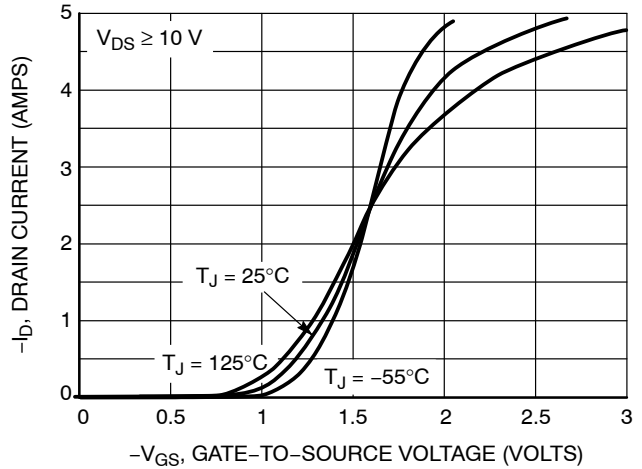

Figure 2. Transfer Characteristics

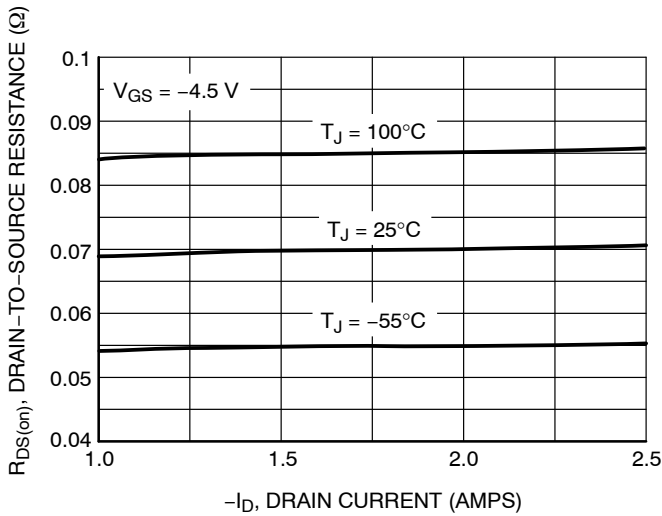

Figure 3. On-Resistance versus Drain Current

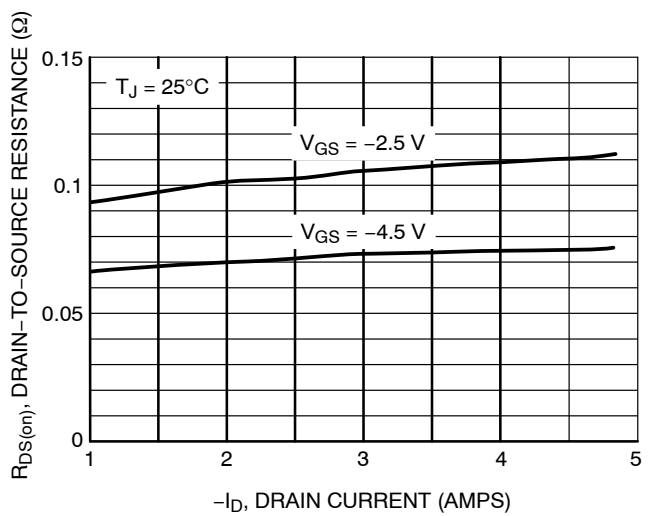

Figure 4. On-Resistance versus Drain Current and Gate Voltage

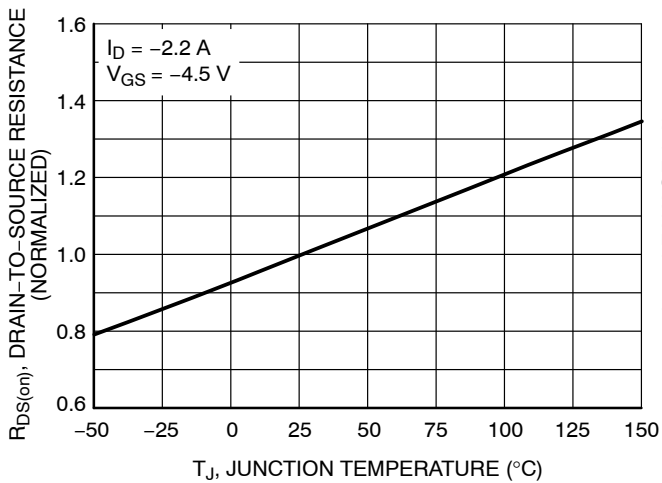

Figure 5. On-Resistance Variation with Temperature

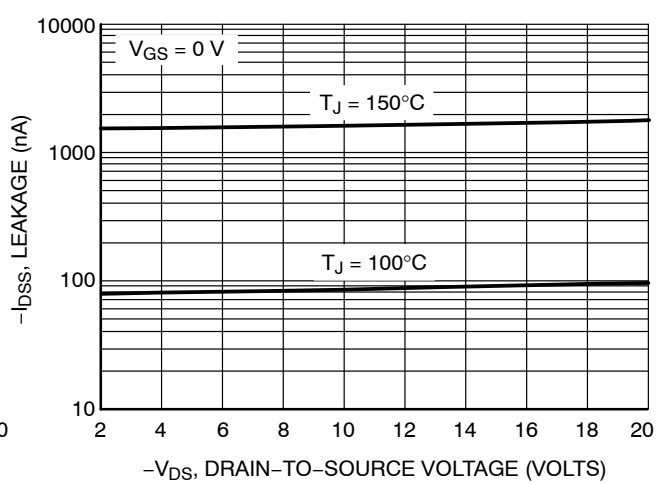

Figure 6. Drain-to-Source Leakage Current versus Voltage

NTLJF3117P

TYPICAL PERFORMANCE CURVES ($T_J = 25^\circ\text{C}$ unless otherwise noted)

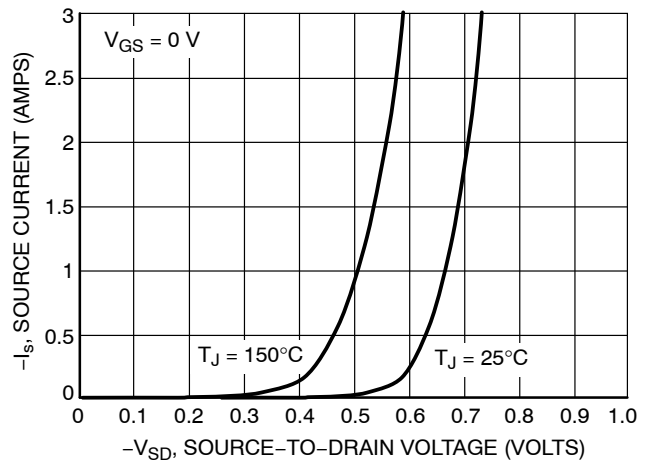
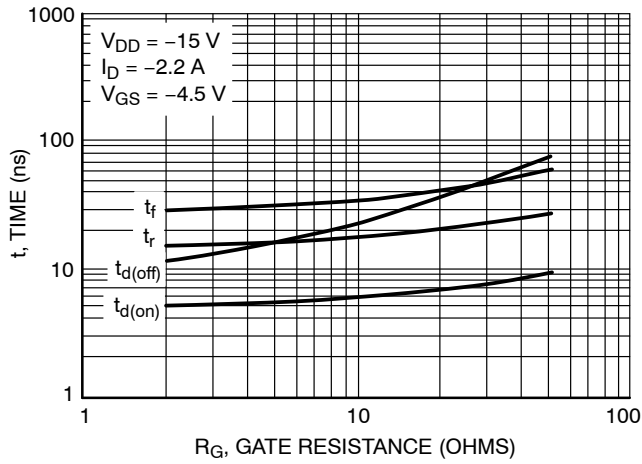
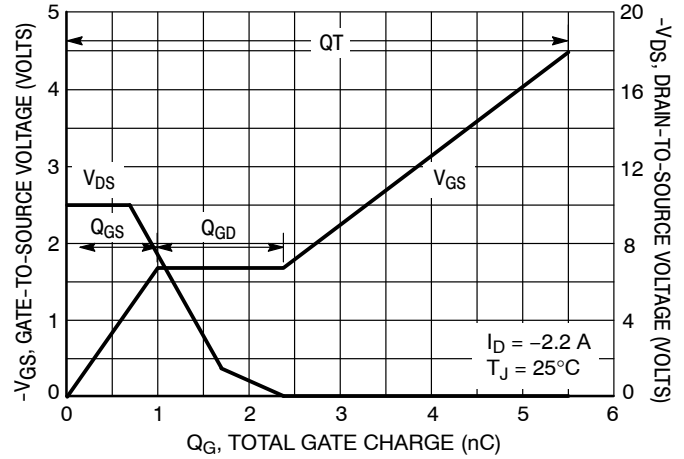
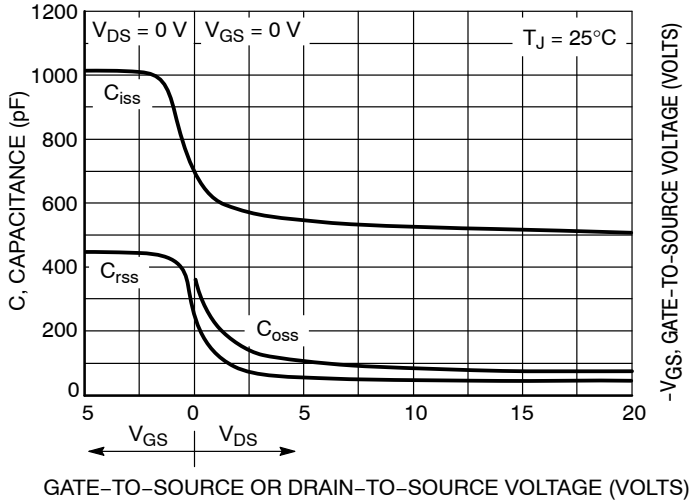

Figure 9. Resistive Switching Time Variation versus Gate Resistance

Figure 10. Diode Forward Voltage versus Current

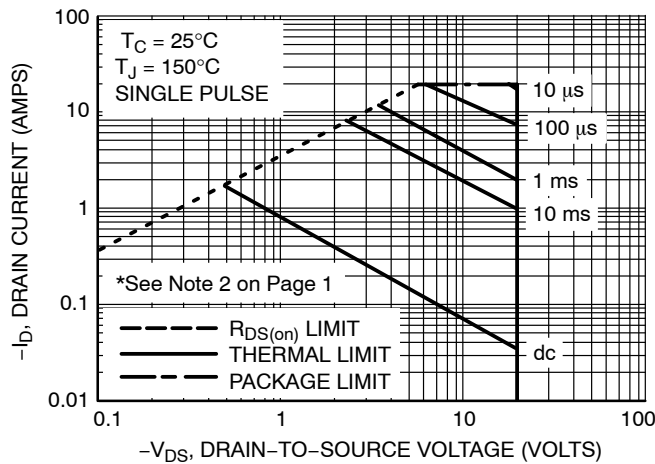

Figure 11. Maximum Rated Forward Biased Safe Operating Area

NTLJF3117P

TYPICAL PERFORMANCE CURVES ($T_J = 25^\circ\text{C}$ unless otherwise noted)

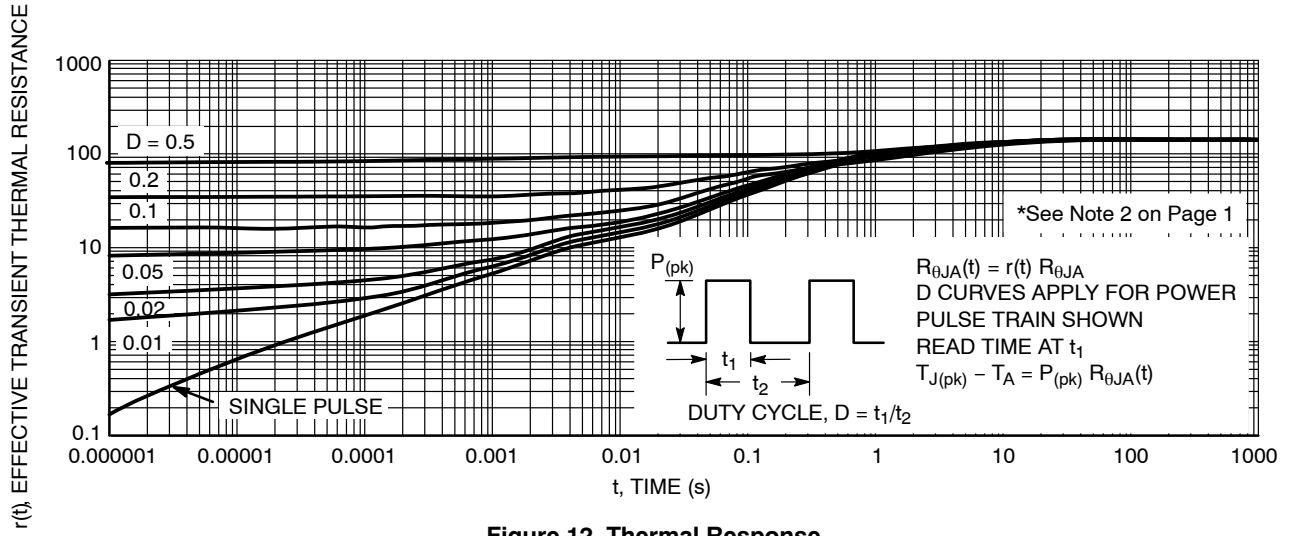

Figure 12. Thermal Response

NTLJF3117P

TYPICAL SCHOTTKY PERFORMANCE CURVES ($T_J = 25^\circ\text{C}$ unless otherwise noted)

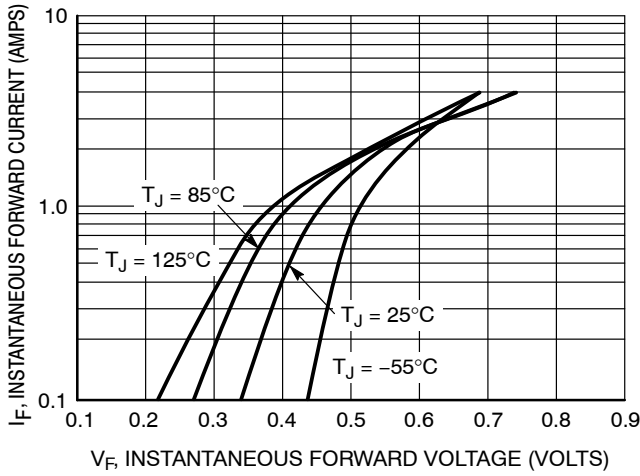

Figure 13. Typical Forward Voltage

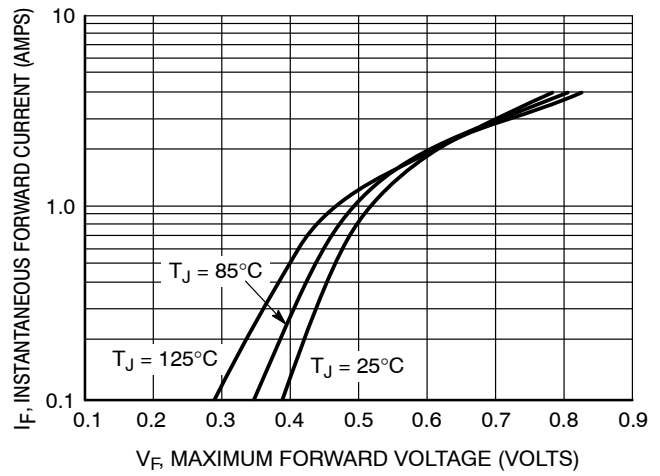

Figure 14. Maximum Forward Voltage

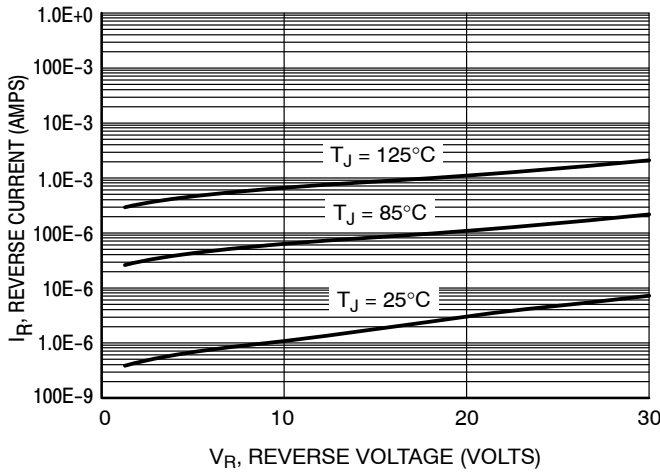

Figure 15. Typical Reverse Current

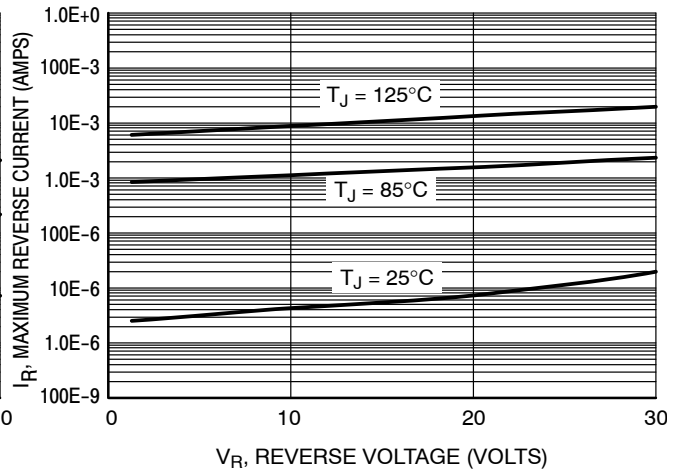

Figure 16. Maximum Reverse Current

ORDERING INFORMATION

Device	Package	Shipping [†]
NTLJF3117PT1G	WDFN6 (Pb-Free)	3000 / Tape & Reel

[†]For information on tape and reel specifications, including part orientation and tape sizes, please refer to our Tape and Reel Packaging Specifications Brochure, BRD8011/D.

MECHANICAL CASE OUTLINE PACKAGE DIMENSIONS

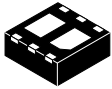

WDFN6 2x2, 0.65P
CASE 506AN
ISSUE H

DATE 25 JAN 2022

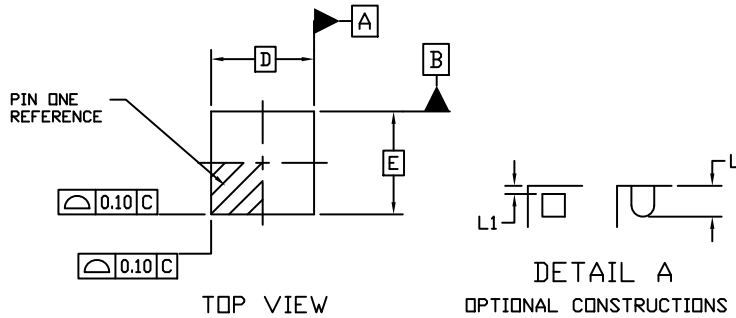

NOTES:

1. DIMENSIONING AND TOLERANCING PER ASME Y14.5M, 1994.
2. CONTROLLING DIMENSION: MILLIMETERS
3. DIMENSION *b* APPLIES TO PLATED TERMINAL AND IS MEASURED BETWEEN 0.15 AND 0.30 MM FROM THE TERMINAL TIP.
4. COPLANARITY APPLIES TO THE EXPOSED PADS AS WELL AS THE TERMINALS.

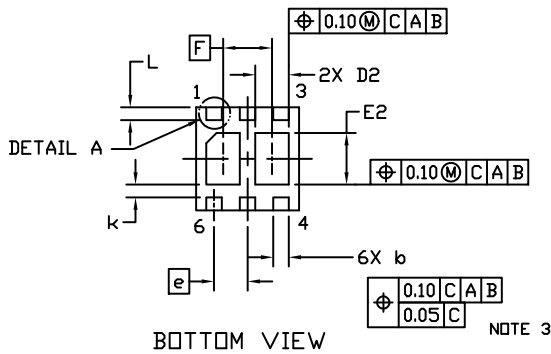
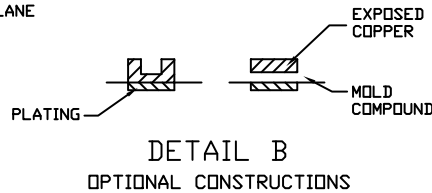
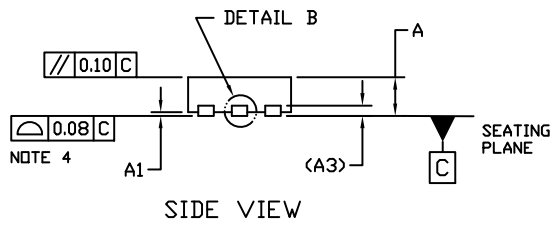

DIM	MILLIMETERS	
	MIN.	MAX.
A	0.70	0.80
A1	0.00	0.05
A3	0.20 REF	
<i>b</i>	0.25	0.35
D	2.00 BSC	
D2	0.57	0.77
E	2.00 BSC	
E2	0.90	1.10
<i>e</i>	0.65 BSC	
F	0.95 BSC	
<i>k</i>	0.25 REF	
L	0.20	0.30
L1	---	0.10

GENERIC MARKING DIAGRAM*



XX = Specific Device Code
M = Date Code

*This information is generic. Please refer to device data sheet for actual part marking. Pb-Free indicator, "G" or microdot "▪", may or may not be present. Some products may not follow the Generic Marking.

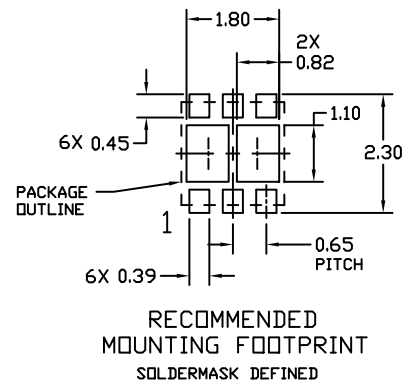

DOCUMENT NUMBER:	98AON20861D	Electronic versions are uncontrolled except when accessed directly from the Document Repository. Printed versions are uncontrolled except when stamped "CONTROLLED COPY" in red.
DESCRIPTION:	WDFN6 2x2, 0.65P	PAGE 1 OF 1

onsemi and ONSEMI are trademarks of Semiconductor Components Industries, LLC dba onsemi or its subsidiaries in the United States and/or other countries. onsemi reserves the right to make changes without further notice to any products herein. onsemi makes no warranty, representation or guarantee regarding the suitability of its products for any particular purpose, nor does onsemi assume any liability arising out of the application or use of any product or circuit, and specifically disclaims any and all liability, including without limitation special, consequential or incidental damages. onsemi does not convey any license under its patent rights nor the rights of others.

onsemi, **Onsemi**, and other names, marks, and brands are registered and/or common law trademarks of Semiconductor Components Industries, LLC dba "**onsemi**" or its affiliates and/or subsidiaries in the United States and/or other countries. **onsemi** owns the rights to a number of patents, trademarks, copyrights, trade secrets, and other intellectual property. A listing of **onsemi**'s product/patent coverage may be accessed at www.onsemi.com/site/pdf/Patent-Marking.pdf. **onsemi** reserves the right to make changes at any time to any products or information herein, without notice. The information herein is provided "as-is" and **onsemi** makes no warranty, representation or guarantee regarding the accuracy of the information, product features, availability, functionality, or suitability of its products for any particular purpose, nor does **onsemi** assume any liability arising out of the application or use of any product or circuit, and specifically disclaims any and all liability, including without limitation special, consequential or incidental damages. Buyer is responsible for its products and applications using **onsemi** products, including compliance with all laws, regulations and safety requirements or standards, regardless of any support or applications information provided by **onsemi**. "Typical" parameters which may be provided in **onsemi** data sheets and/or specifications can and do vary in different applications and actual performance may vary over time. All operating parameters, including "Typicals" must be validated for each customer application by customer's technical experts. **onsemi** does not convey any license under any of its intellectual property rights nor the rights of others. **onsemi** products are not designed, intended, or authorized for use as a critical component in life support systems or any FDA Class 3 medical devices or medical devices with a same or similar classification in a foreign jurisdiction or any devices intended for implantation in the human body. Should Buyer purchase or use **onsemi** products for any such unintended or unauthorized application, Buyer shall indemnify and hold **onsemi** and its officers, employees, subsidiaries, affiliates, and distributors harmless against all claims, costs, damages, and expenses, and reasonable attorney fees arising out of, directly or indirectly, any claim of personal injury or death associated with such unintended or unauthorized use, even if such claim alleges that **onsemi** was negligent regarding the design or manufacture of the part. **onsemi** is an Equal Opportunity/Affirmative Action Employer. This literature is subject to all applicable copyright laws and is not for resale in any manner.

ADDITIONAL INFORMATION

TECHNICAL PUBLICATIONS:

Technical Library: www.onsemi.com/design/resources/technical-documentation
onsemi Website: www.onsemi.com

ONLINE SUPPORT: www.onsemi.com/support

For additional information, please contact your local Sales Representative at www.onsemi.com/support/sales