

# NTST20100CTG, NTSB20100CT-1G, NTSJ20100CTG, NTSB20100CTG

## Trench-based Dual Schottky Rectifier, Very Low Forward Voltage, 20A, 100V

### Features

- Fine Lithography Trench-based Schottky Technology for Very Low Forward Voltage and Low Leakage
- Fast Switching with Exceptional Temperature Stability
- Low Power Loss and Lower Operating Temperature
- Higher Efficiency for Achieving Regulatory Compliance
- Low Thermal Resistance
- High Surge Capability
- These are Pb-Free Devices

### Typical Applications

- Switching Power Supplies including Notebook / Netbook Adapters, ATX and Flat Panel Display
- High Frequency and DC-DC Converters
- Freewheeling and OR-ing diodes
- Reverse Battery Protection
- Instrumentation

### Mechanical Characteristics

- Case: Epoxy, Molded
- Epoxy Meets Flammability Rating UL 94-0 @ 0.125 in
- Finish: All External Surfaces Corrosion Resistant and Terminal Leads are Readily Solderable
- Lead Temperature for Soldering Purposes: 260°C Maximum for 10 sec



ON Semiconductor®

[www.onsemi.com](http://www.onsemi.com)

### PIN CONNECTIONS

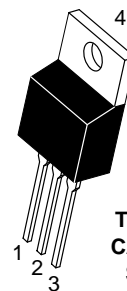
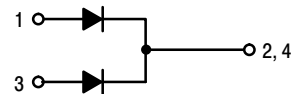

TO-220AB  
CASE 221A  
STYLE 6

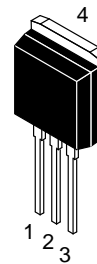

I2PAK  
CASE 418D  
STYLE 3

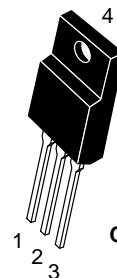

TO-220FP  
CASE 221AH

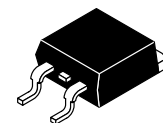

D2PAK  
CASE 418B

### ORDERING INFORMATION

See detailed ordering and shipping information in the package dimensions section on page 5 of this data sheet.

# NTST20100CTG, NTSB20100CT-1G, NTSJ20100CTG, NTSB20100CTG

## MAXIMUM RATINGS

| Rating   | Symbol                          | Value       | Unit             |
|--|---------------------------------|-------------|------------------|
| Peak Repetitive Reverse Voltage<br>Working Peak Reverse Voltage<br>DC Blocking Voltage                     | $V_{RRM}$<br>$V_{RWM}$<br>$V_R$ | 100         | V                |
| Average Rectified Forward Current<br>(Rated $V_R$ , $T_C = 130^\circ\text{C}$ )                            | $I_{F(AV)}$                     | 20<br>10    | A                |
| Peak Repetitive Forward Current<br>(Rated $V_R$ , Square Wave, 20 kHz, $T_C = 125^\circ\text{C}$ )         | $I_{FRM}$                       | 40<br>20    | A                |
| Nonrepetitive Peak Surge Current<br>(Surge applied at rated load conditions halfwave, single phase, 60 Hz) | $I_{FSM}$                       | 150         | A                |
| Operating Junction Temperature   | $T_J$                           | -40 to +150 | $^\circ\text{C}$ |
| Storage Temperature  | $T_{stg}$                       | -40 to +150 | $^\circ\text{C}$ |
| Voltage Rate of Change (Rated $V_R$ )  | dv/dt                           | 10,000      | V/ $\mu\text{s}$ |

Stresses exceeding those listed in the Maximum Ratings table may damage the device. If any of these limits are exceeded, device functionality should not be assumed, damage may occur and reliability may be affected.

## THERMAL CHARACTERISTICS

| Rating  | Symbol                             | NTST20100CTG,<br>NTSB20100CT-1G | NTSB20100CTG | NTSJ20100CTG | Unit   |
|---|------------------------------------|---------------------------------|--------------|--------------|--|
| Maximum Thermal Resistance per Diode<br>Junction-to-Case<br>Junction-to-Ambient | $R_{\theta JC}$<br>$R_{\theta JA}$ | 2.5<br>70                       | 1.5<br>46.9  | 4.49<br>105  | $^\circ\text{C}/\text{W}$<br>$^\circ\text{C}/\text{W}$ |

## ELECTRICAL CHARACTERISTICS (Per Leg unless otherwise noted)

| Rating   | Symbol | Typ                              | Max                        | Unit   |
|--|--------|----------------------------------|----------------------------|--|
| Maximum Instantaneous Forward Voltage (Note 1)<br>( $I_F = 5\text{ A}$ , $T_J = 25^\circ\text{C}$ )<br>( $I_F = 10\text{ A}$ , $T_J = 25^\circ\text{C}$ )<br><br>( $I_F = 5\text{ A}$ , $T_J = 125^\circ\text{C}$ )<br>( $I_F = 10\text{ A}$ , $T_J = 125^\circ\text{C}$ ) | $V_F$  | 0.55<br>0.65<br><br>0.50<br>0.58 | -<br>0.83<br><br>-<br>0.68 | V  |
| Maximum Instantaneous Reverse Current (Note 1)<br>( $V_R = 70\text{ V}$ , $T_J = 25^\circ\text{C}$ )<br>( $V_R = 70\text{ V}$ , $T_J = 125^\circ\text{C}$ )<br><br>(Rated dc Voltage, $T_J = 25^\circ\text{C}$ )<br>(Rated dc Voltage, $T_J = 125^\circ\text{C}$ )         | $I_R$  | 17<br>5.3<br><br>-<br>12         | -<br>-<br><br>800<br>25    | $\mu\text{A}$<br>mA<br><br>$\mu\text{A}$<br>mA |

Product parametric performance is indicated in the Electrical Characteristics for the listed test conditions, unless otherwise noted. Product performance may not be indicated by the Electrical Characteristics if operated under different conditions.

1. Pulse Test: Pulse Width = 300  $\mu\text{s}$ , Duty Cycle  $\leq 2.0\%$

TYPICAL CHARACTERISTICS

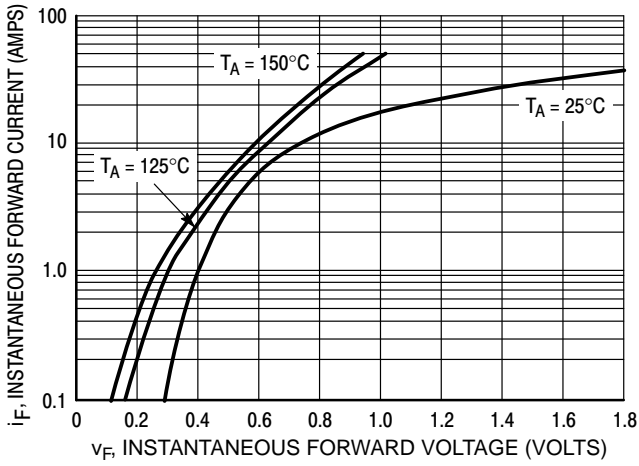

Figure 1. Typical Forward Voltage

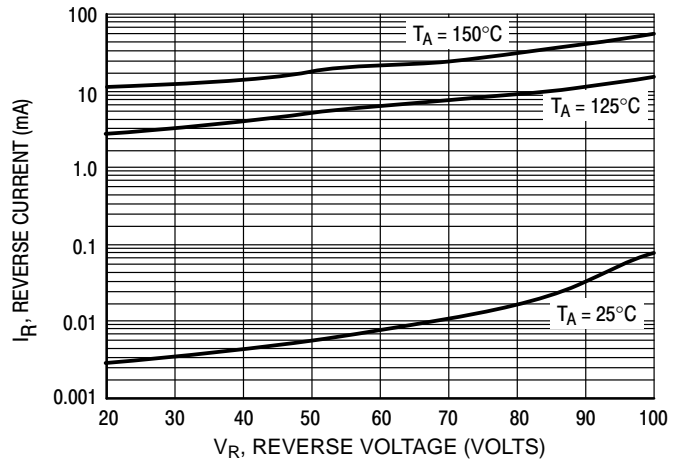

Figure 2. Typical Reverse Current

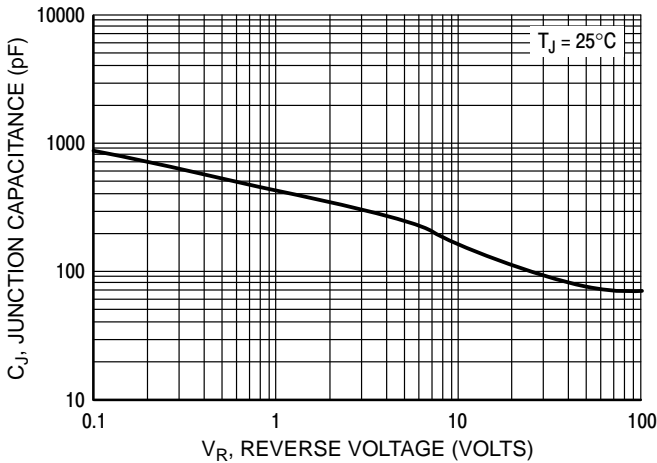

Figure 3. Typical Junction Capacitance

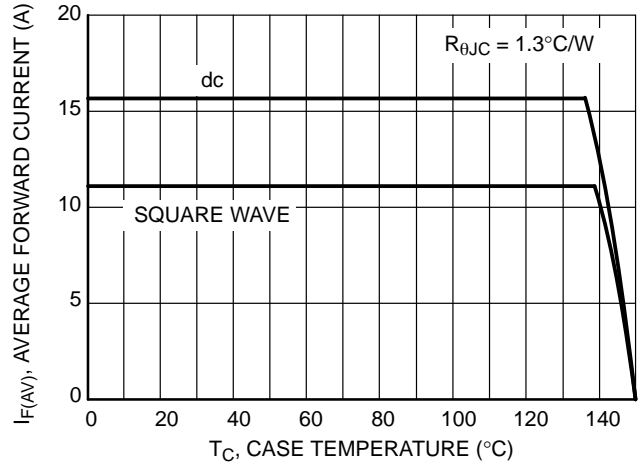

Figure 4. Current Derating per Leg

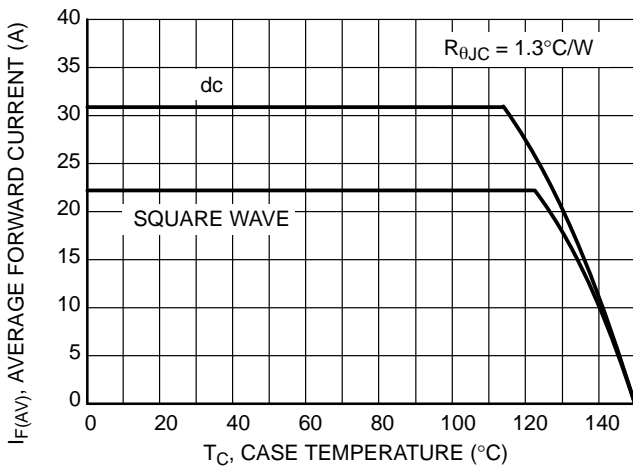

Figure 5. Current Derating

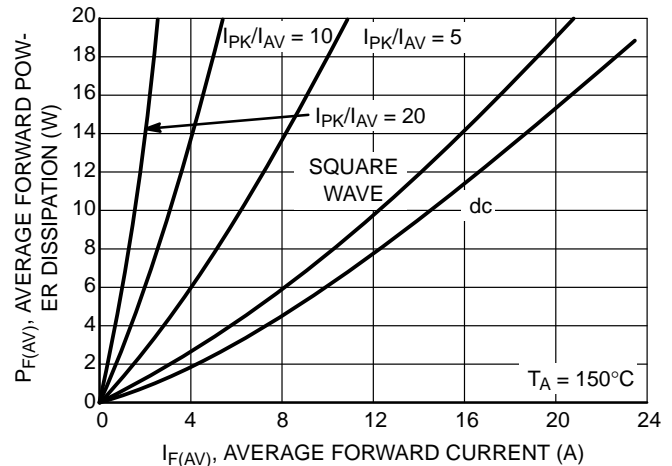

Figure 6. Forward Power Dissipation

TYPICAL CHARACTERISTICS

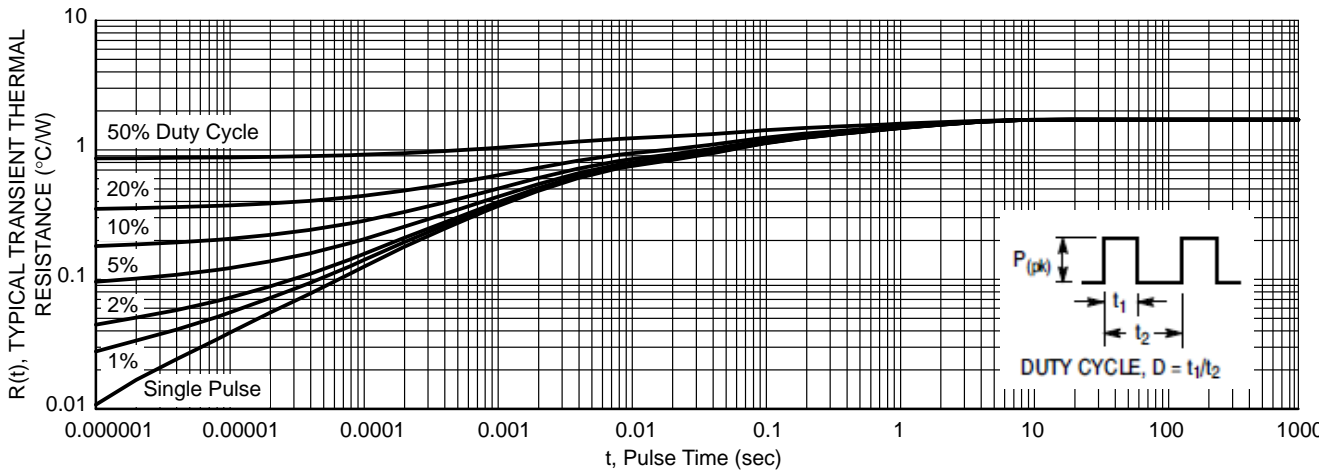

Figure 7. Typical Transient Thermal Response, Junction-to-Case for NTST20100CT and NTSB20100CT-1G

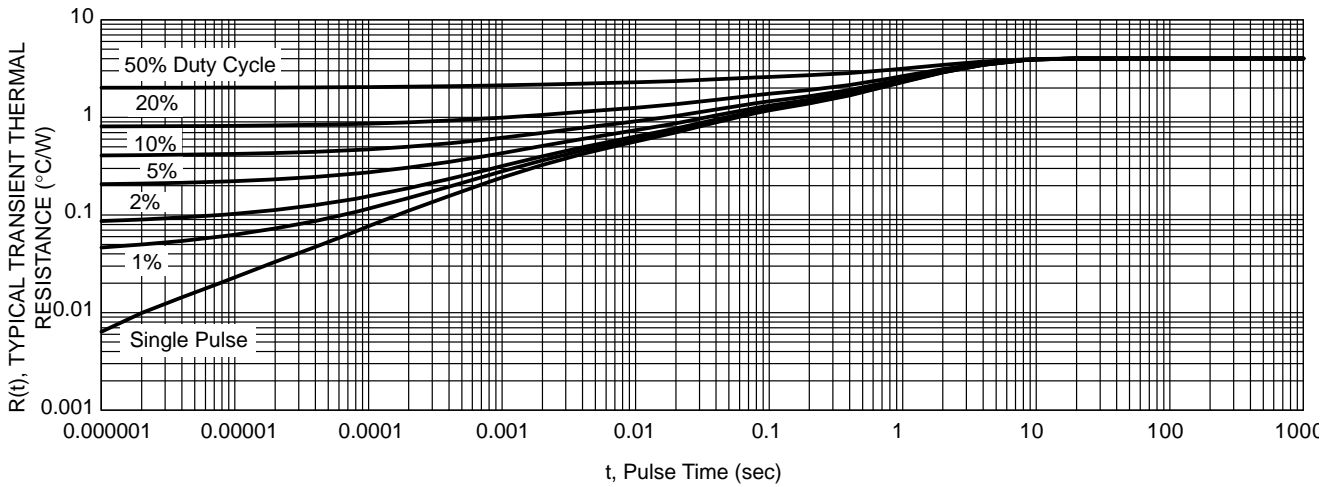

Figure 8. Typical Transient Thermal Response, Junction-to-Case for NTSJ20100CTG

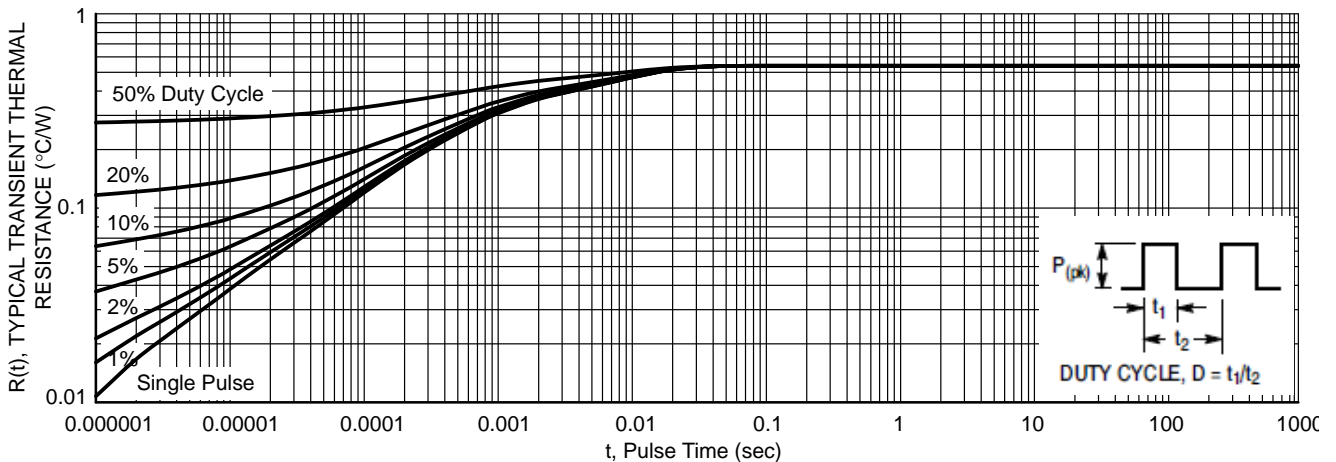

Figure 9. Typical Transient Thermal Response for NTSB20100CTG

# NTST20100CTG, NTSB20100CT-1G, NTSJ20100CTG, NTSB20100CTG

## ORDERING INFORMATION

| Device         | Package                         | Shipping          |
|----------------|---------------------------------|-------------------|
| NTST20100CTG   | TO-220AB<br>(Pb-Free)           | 50 Units / Rail   |
| NTSB20100CT-1G | I <sup>2</sup> PAK<br>(Pb-Free) | 50 Units / Rail   |
| NTSJ20100CTG   | TO-220FP<br>(Halide-Free)       | 50 Units / Rail   |
| NTSB20100CTG   | D <sup>2</sup> PAK<br>(Pb-Free) | 50 Units / Rail   |
| NTSB20100CTT4G | D <sup>2</sup> PAK<br>(Pb-Free) | 800 / Tape & Reel |

## MARKING DIAGRAMS

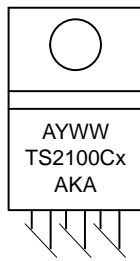

TO-220AB

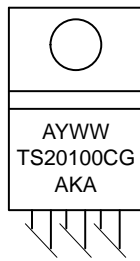

TO-220FP

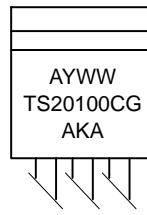

I<sup>2</sup>PAK

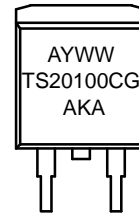

D<sup>2</sup>PAK

- A = Assembly Location
- Y = Year
- WW = Work Week
- AKA = Polarity Designator
- x = G or H
- G = Pb-Free Package
- H = Halide-Free Package

# MECHANICAL CASE OUTLINE

## PACKAGE DIMENSIONS

ON Semiconductor®



### TO-220 FULLPACK, 3-LEAD CASE 221AH ISSUE F

DATE 30 SEP 2014

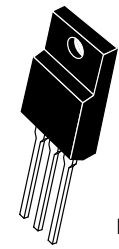

SCALE 1:1

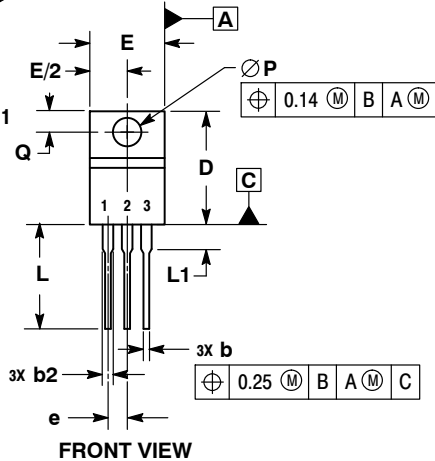

FRONT VIEW



SECTION D-D

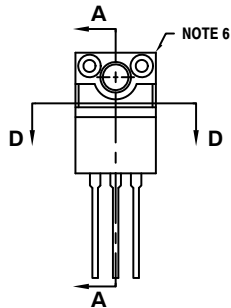

ALTERNATE CONSTRUCTION

STYLE 1:  
PIN 1. MAIN TERMINAL 1  
2. MAIN TERMINAL 2  
3. GATE

STYLE 2:  
PIN 1. CATHODE  
2. ANODE  
3. GATE

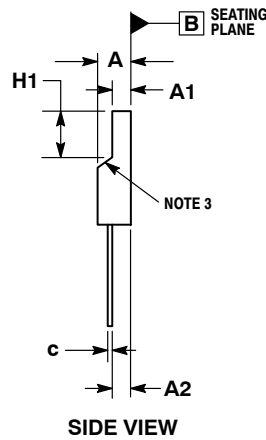

SIDE VIEW

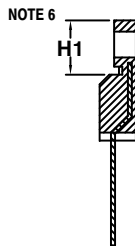

SECTION A-A

NOTES:

1. DIMENSIONING AND TOLERANCING PER ASME Y14.5M, 1994.
2. CONTROLLING DIMENSION: MILLIMETERS.
3. CONTOUR UNCONTROLLED IN THIS AREA.
4. DIMENSIONS D AND E DO NOT INCLUDE MOLD FLASH AND GATE PROTRUSIONS. MOLD FLASH AND GATE PROTRUSIONS NOT TO EXCEED 0.13 PER SIDE. THESE DIMENSIONS ARE TO BE MEASURED AT OUTERMOST EXTREME OF THE PLASTIC BODY.
5. DIMENSION b2 DOES NOT INCLUDE DAMBAR PROTRUSION. LEAD WIDTH INCLUDING PROTRUSION SHALL NOT EXCEED 2.00.
6. CONTOURS AND FEATURES OF THE MOLDED PACKAGE BODY MAY VARY WITHIN THE ENVELOPE DEFINED BY DIMENSIONS A1 AND H1 FOR MANUFACTURING PURPOSES.

| MILLIMETERS |          |       |
|-------------|----------|-------|
| DIM         | MIN      | MAX   |
| A           | 4.30     | 4.70  |
| A1          | 2.50     | 2.90  |
| A2          | 2.50     | 2.90  |
| b           | 0.54     | 0.84  |
| b2          | 1.10     | 1.40  |
| c           | 0.49     | 0.79  |
| D           | 14.70    | 15.30 |
| E           | 9.70     | 10.30 |
| e           | 2.54 BSC |       |
| H1          | 6.60     | 7.10  |
| L           | 12.50    | 14.73 |
| L1          | ---      | 2.80  |
| P           | 3.00     | 3.40  |
| Q           | 2.80     | 3.20  |

### GENERIC MARKING DIAGRAM\*

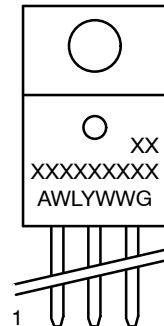

A = Assembly Location  
WL = Wafer Lot  
Y = Year  
WW = Work Week  
G = Pb-Free Package

\*This information is generic. Please refer to device data sheet for actual part marking. Pb-Free indicator, "G" or microdot "▪", may or may not be present.

|                  |                         |  |
|------------------|-------------------------|--|
| DOCUMENT NUMBER: | 98AON52577E             | Electronic versions are uncontrolled except when accessed directly from the Document Repository. Printed versions are uncontrolled except when stamped "CONTROLLED COPY" in red. |
| DESCRIPTION:     | TO-220 FULLPACK, 3-LEAD | PAGE 1 OF 1  |

ON Semiconductor and ON are trademarks of Semiconductor Components Industries, LLC dba ON Semiconductor or its subsidiaries in the United States and/or other countries. ON Semiconductor reserves the right to make changes without further notice to any products herein. ON Semiconductor makes no warranty, representation or guarantee regarding the suitability of its products for any particular purpose, nor does ON Semiconductor assume any liability arising out of the application or use of any product or circuit, and specifically disclaims any and all liability, including without limitation special, consequential or incidental damages. ON Semiconductor does not convey any license under its patent rights nor the rights of others.

# MECHANICAL CASE OUTLINE

## PACKAGE DIMENSIONS

ON Semiconductor®

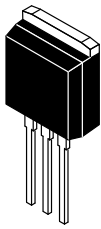

SCALE 1:1

I<sup>2</sup>PAK (TO-262)  
CASE 418D-01  
ISSUE D

DATE 16 OCT 2007

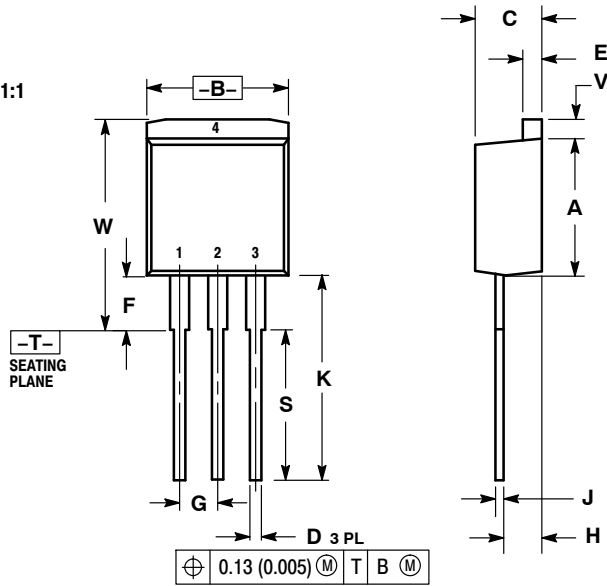

NOTES:  
1. DIMENSIONING AND TOLERANCING PER ANSI Y14.5M, 1982.  
2. CONTROLLING DIMENSION: INCH.

| DIM | INCHES    |       | MILLIMETERS |       |
|-----|-----------|-------|-------------|-------|
|     | MIN       | MAX   | MIN         | MAX   |
| A   | 0.335     | 0.380 | 8.51        | 9.65  |
| B   | 0.380     | 0.406 | 9.65        | 10.31 |
| C   | 0.160     | 0.185 | 4.06        | 4.70  |
| D   | 0.026     | 0.035 | 0.66        | 0.89  |
| E   | 0.045     | 0.055 | 1.14        | 1.40  |
| F   | 0.122 REF |       | 3.10 REF    |       |
| G   | 0.100 BSC |       | 2.54 BSC    |       |
| H   | 0.094     | 0.110 | 2.39        | 2.79  |
| J   | 0.013     | 0.025 | 0.33        | 0.64  |
| K   | 0.500     | 0.562 | 12.70       | 14.27 |
| S   | 0.390 REF |       | 9.90 REF    |       |
| V   | 0.045     | 0.070 | 1.14        | 1.78  |
| W   | 0.522     | 0.551 | 13.25       | 14.00 |

STYLE 1:

- PIN 1. BASE
- 2. COLLECTOR
- 3. EMITTER
- 4. COLLECTOR

STYLE 2:

- PIN 1. GATE
- 2. DRAIN
- 3. SOURCE
- 4. DRAIN

STYLE 3:

- PIN 1. ANODE
- 2. CATHODE
- 3. ANODE
- 4. CATHODE

STYLE 4:

- PIN 1. GATE
- 2. COLLECTOR
- 3. EMITTER
- 4. COLLECTOR

|                         |                                  |   |
|-------------------------|----------------------------------|---|
| <b>DOCUMENT NUMBER:</b> | <b>98ASB16716C</b>               | Electronic versions are uncontrolled except when accessed directly from the Document Repository.<br>Printed versions are uncontrolled except when stamped "CONTROLLED COPY" in red. |
| <b>DESCRIPTION:</b>     | <b>I<sup>2</sup>PAK (TO-262)</b> | <b>PAGE 1 OF 1</b>  |

ON Semiconductor and are trademarks of Semiconductor Components Industries, LLC dba ON Semiconductor or its subsidiaries in the United States and/or other countries. ON Semiconductor reserves the right to make changes without further notice to any products herein. ON Semiconductor makes no warranty, representation or guarantee regarding the suitability of its products for any particular purpose, nor does ON Semiconductor assume any liability arising out of the application or use of any product or circuit, and specifically disclaims any and all liability, including without limitation special, consequential or incidental damages. ON Semiconductor does not convey any license under its patent rights nor the rights of others.

# MECHANICAL CASE OUTLINE

## PACKAGE DIMENSIONS

ON Semiconductor®

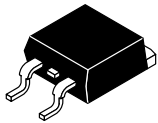

**D<sup>2</sup>PAK 3**  
CASE 418B-04  
ISSUE L

DATE 17 FEB 2015

SCALE 1:1

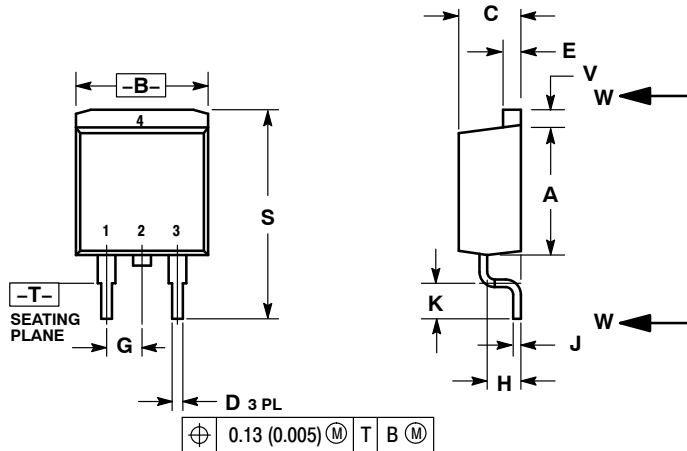

**NOTES:**

1. DIMENSIONING AND TOLERANCING PER ANSI Y14.5M, 1982.
2. CONTROLLING DIMENSION: INCH.
3. 418B-01 THRU 418B-03 OBSOLETE, NEW STANDARD 418B-04.

| DIM | INCHES |       | MILLIMETERS |       |
|-----|--------|-------|-------------|-------|
|     | MIN    | MAX   | MIN         | MAX   |
| A   | 0.340  | 0.380 | 8.64        | 9.65  |
| B   | 0.380  | 0.405 | 9.65        | 10.29 |
| C   | 0.160  | 0.190 | 4.06        | 4.83  |
| D   | 0.020  | 0.035 | 0.51        | 0.89  |
| E   | 0.045  | 0.055 | 1.14        | 1.40  |
| F   | 0.310  | 0.350 | 7.87        | 8.89  |
| G   | 0.100  | BSC   | 2.54        | BSC   |
| H   | 0.080  | 0.110 | 2.03        | 2.79  |
| J   | 0.018  | 0.025 | 0.46        | 0.64  |
| K   | 0.090  | 0.110 | 2.29        | 2.79  |
| L   | 0.052  | 0.072 | 1.32        | 1.83  |
| M   | 0.280  | 0.320 | 7.11        | 8.13  |
| N   | 0.197  | REF   | 5.00        | REF   |
| P   | 0.079  | REF   | 2.00        | REF   |
| R   | 0.039  | REF   | 0.99        | REF   |
| S   | 0.575  | 0.625 | 14.60       | 15.88 |
| V   | 0.045  | 0.055 | 1.14        | 1.40  |

**VARIABLE CONFIGURATION ZONE**

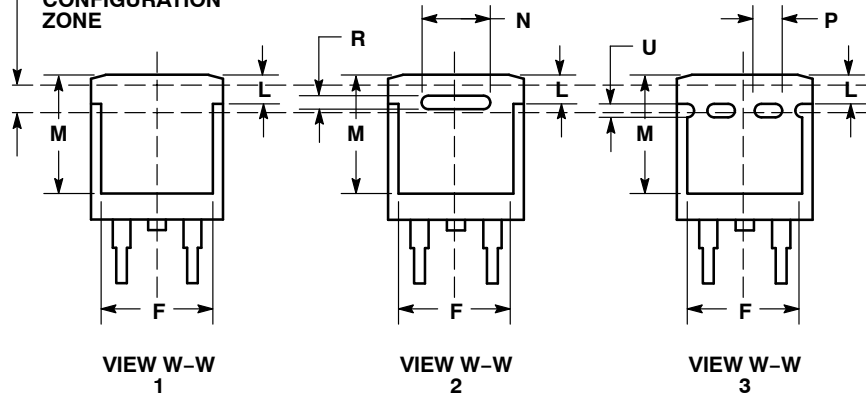

- |  |   |   |  |   |  |
|--|---|---|--|---|--|
| <b>STYLE 1:</b><br>PIN 1. BASE<br>2. COLLECTOR<br>3. EMITTER<br>4. COLLECTOR | <b>STYLE 2:</b><br>PIN 1. GATE<br>2. DRAIN<br>3. SOURCE<br>4. DRAIN | <b>STYLE 3:</b><br>PIN 1. ANODE<br>2. CATHODE<br>3. ANODE<br>4. CATHODE | <b>STYLE 4:</b><br>PIN 1. GATE<br>2. COLLECTOR<br>3. EMITTER<br>4. COLLECTOR | <b>STYLE 5:</b><br>PIN 1. CATHODE<br>2. ANODE<br>3. CATHODE<br>4. ANODE | <b>STYLE 6:</b><br>PIN 1. NO CONNECT<br>2. CATHODE<br>3. ANODE<br>4. CATHODE |
|--|---|---|--|---|--|

**MARKING INFORMATION AND FOOTPRINT ON PAGE 2**

|                         |                           |  |
|-------------------------|---------------------------|--|
| <b>DOCUMENT NUMBER:</b> | <b>98ASB42761B</b>        | Electronic versions are uncontrolled except when accessed directly from the Document Repository. Printed versions are uncontrolled except when stamped "CONTROLLED COPY" in red. |
| <b>DESCRIPTION:</b>     | <b>D<sup>2</sup>PAK 3</b> | <b>PAGE 1 OF 2</b>   |

ON Semiconductor and are trademarks of Semiconductor Components Industries, LLC dba ON Semiconductor or its subsidiaries in the United States and/or other countries. ON Semiconductor reserves the right to make changes without further notice to any products herein. ON Semiconductor makes no warranty, representation or guarantee regarding the suitability of its products for any particular purpose, nor does ON Semiconductor assume any liability arising out of the application or use of any product or circuit, and specifically disclaims any and all liability, including without limitation special, consequential or incidental damages. ON Semiconductor does not convey any license under its patent rights nor the rights of others.



**D<sup>2</sup>PAK 3**  
CASE 418B-04  
ISSUE L

DATE 17 FEB 2015

**GENERIC  
MARKING DIAGRAM\***

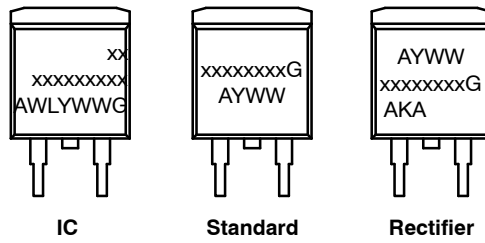

- xx = Specific Device Code
- A = Assembly Location
- WL = Wafer Lot
- Y = Year
- WW = Work Week
- G = Pb-Free Package
- AKA = Polarity Indicator

\*This information is generic. Please refer to device data sheet for actual part marking. Pb-Free indicator, "G" or microdot "▪", may or may not be present.

**SOLDERING FOOTPRINT\***

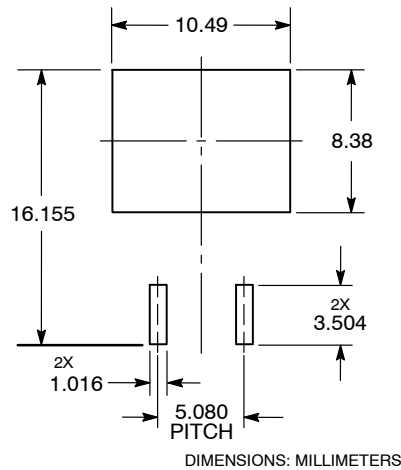

DIMENSIONS: MILLIMETERS

\*For additional information on our Pb-Free strategy and soldering details, please download the ON Semiconductor Soldering and Mounting Techniques Reference Manual, SOLDERRM/D.

|                         |                           |  |
|-------------------------|---------------------------|--|
| <b>DOCUMENT NUMBER:</b> | <b>98ASB42761B</b>        | Electronic versions are uncontrolled except when accessed directly from the Document Repository. Printed versions are uncontrolled except when stamped "CONTROLLED COPY" in red. |
| <b>DESCRIPTION:</b>     | <b>D<sup>2</sup>PAK 3</b> | <b>PAGE 2 OF 2</b>   |

ON Semiconductor and are trademarks of Semiconductor Components Industries, LLC dba ON Semiconductor or its subsidiaries in the United States and/or other countries. ON Semiconductor reserves the right to make changes without further notice to any products herein. ON Semiconductor makes no warranty, representation or guarantee regarding the suitability of its products for any particular purpose, nor does ON Semiconductor assume any liability arising out of the application or use of any product or circuit, and specifically disclaims any and all liability, including without limitation special, consequential or incidental damages. ON Semiconductor does not convey any license under its patent rights nor the rights of others.

**onsemi**, **Onsemi**, and other names, marks, and brands are registered and/or common law trademarks of Semiconductor Components Industries, LLC dba "**onsemi**" or its affiliates and/or subsidiaries in the United States and/or other countries. **onsemi** owns the rights to a number of patents, trademarks, copyrights, trade secrets, and other intellectual property. A listing of **onsemi**'s product/patent coverage may be accessed at [www.onsemi.com/site/pdf/Patent-Marking.pdf](http://www.onsemi.com/site/pdf/Patent-Marking.pdf). **onsemi** reserves the right to make changes at any time to any products or information herein, without notice. The information herein is provided "as-is" and **onsemi** makes no warranty, representation or guarantee regarding the accuracy of the information, product features, availability, functionality, or suitability of its products for any particular purpose, nor does **onsemi** assume any liability arising out of the application or use of any product or circuit, and specifically disclaims any and all liability, including without limitation special, consequential or incidental damages. Buyer is responsible for its products and applications using **onsemi** products, including compliance with all laws, regulations and safety requirements or standards, regardless of any support or applications information provided by **onsemi**. "Typical" parameters which may be provided in **onsemi** data sheets and/or specifications can and do vary in different applications and actual performance may vary over time. All operating parameters, including "Typicals" must be validated for each customer application by customer's technical experts. **onsemi** does not convey any license under any of its intellectual property rights nor the rights of others. **onsemi** products are not designed, intended, or authorized for use as a critical component in life support systems or any FDA Class 3 medical devices or medical devices with a same or similar classification in a foreign jurisdiction or any devices intended for implantation in the human body. Should Buyer purchase or use **onsemi** products for any such unintended or unauthorized application, Buyer shall indemnify and hold **onsemi** and its officers, employees, subsidiaries, affiliates, and distributors harmless against all claims, costs, damages, and expenses, and reasonable attorney fees arising out of, directly or indirectly, any claim of personal injury or death associated with such unintended or unauthorized use, even if such claim alleges that **onsemi** was negligent regarding the design or manufacture of the part. **onsemi** is an Equal Opportunity/Affirmative Action Employer. This literature is subject to all applicable copyright laws and is not for resale in any manner.

## ADDITIONAL INFORMATION

### TECHNICAL PUBLICATIONS:

Technical Library: [www.onsemi.com/design/resources/technical-documentation](http://www.onsemi.com/design/resources/technical-documentation)  
onsemi Website: [www.onsemi.com](http://www.onsemi.com)

### ONLINE SUPPORT: [www.onsemi.com/support](http://www.onsemi.com/support)

For additional information, please contact your local Sales Representative at [www.onsemi.com/support/sales](http://www.onsemi.com/support/sales)