

# NZF220DFT1G, SNZF220DFT1G

## EMI Filter with ESD Protection

### Features

- 2 EMI/RFI Bi-directional “Pi” Low-Pass Filters
- ESD Protection Meets IEC61000-4-2
- Diode Capacitance: 7 – 10 pF
- Zener/Resistor Line Capacitance:  $22 \pm 20\%$  pF
- Low Zener Diode Leakage: 1  $\mu$ A Maximum
- Zener Breakdown Voltage; 6 – 8 V
- AEC-Q101 Qualified and PPAP Capable – SNZF220DFT1G
- S Prefix for Automotive and Other Applications Requiring Unique Site and Control Change Requirements
- These are Pb-Free Devices

### Benefits

- Designed to suppress EMI/RFI Noise in Systems Subjected to Electromagnetic Interference
- Nominal Cutoff Frequency of 220 MHz (per Figure 2)
- Small Package Size Minimizes Parasitic Inductance, Thus a More “Ideal” Low Pass Filtering Response

### Typical Applications

- Cellular Phones
- Communication Systems
- Computers
- Portable Products with Input/Output Conductors

### MAXIMUM RATINGS

Rating	Symbol	Value	Unit
Peak Power Dissipation (Note 1) 8 × 20 $\mu$ s Pulse	$P_{PK}$	14	W
Maximum Junction Temperature	$T_J$	150	$^{\circ}$ C

Maximum ratings are those values beyond which device damage can occur. Maximum ratings applied to the device are individual stress limit values (not normal operating conditions) and are not valid simultaneously. If these limits are exceeded, device functional operation is not implied, damage may occur and reliability may be affected.

1. Between I/O Pins



ON Semiconductor®

<http://onsemi.com>

### CIRCUIT DESCRIPTION

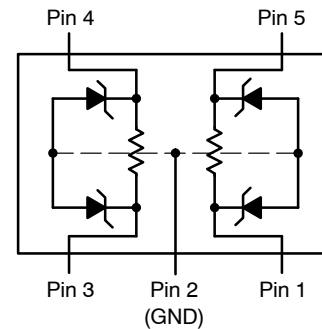

SC-88A  
DF SUFFIX  
CASE 419A

### MARKING DIAGRAM

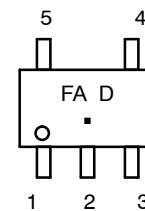

FA = Specific Device Code  
D = Date Code  
▪ = Pb-Free Package

### ORDERING INFORMATION

Device	Package	Shipping†
NZF220DFT1G	SC-88A (Pb-Free)	3000 / Tape & Reel
SNZF220DFT1G	SC-88A (Pb-Free)	3000 / Tape & Reel

†For information on tape and reel specifications, including part orientation and tape sizes, please refer to our Tape and Reel Packaging Specifications Brochure, BRD8011/D.

# NZF220DFT1G, SNZF220DFT1G

## ELECTRICAL CHARACTERISTICS

Symbol	Characteristic	Min	Typ	Max	Unit
$V_Z$	Zener Breakdown Voltage, @ $I_{ZT} = 1$ mA	6.0	–	8.0	V
$I_r$	Zener Leakage Current, @ $V_R = 3$ V	N/A	–	1.0	$\mu$ A
$V_F$	Zener Forward Voltage, @ $I_F = 50$ mA	N/A	–	1.5	V
Capacitance	Zener Internal Capacitance, @ 0 V Bias	7.0	–	10	pF
Capacitance	Zener/Resistor Array Line Capacitance	17.6	–	26.4	pF
Resistor	Resistance	90	–	110	$\Omega$
$F_C$ (Note 2)	Cutoff Frequency	–	220	–	MHz

2. 50  $\Omega$  Source and 50  $\Omega$  Lead Termination per Figure 2.

## Applications Information

### Suppressing Noise at the Source

- Filter all I/O signals leaving the noisy environment
- Locate I/O driver circuits close to the connector
- Use the longest rise/fall times possible for all digital signals

### Reducing Noise at the Receiver

- Filter all I/O signals entering the unit
- Locate the I/O filters as close as possible to the connector

### Minimizing Noise Coupling

- Use multilayer PCBs to minimize power and ground inductance
- Keep clock circuits away from the I/O connector
- Ground planes should be used whenever possible
- Minimize the loop area for all high speed signals
- Provide for adequate power decoupling

### ESD Protection

- Locate the suppression devices as close to the I/O connector as possible
- Minimize the PCB trace length to the suppression device
- Minimize the PCB trace length for the ground return for the suppression device

# NZF220DFT1G, SNZF220DFT1G

## FREQUENCY RESPONSE SPECIFICATION

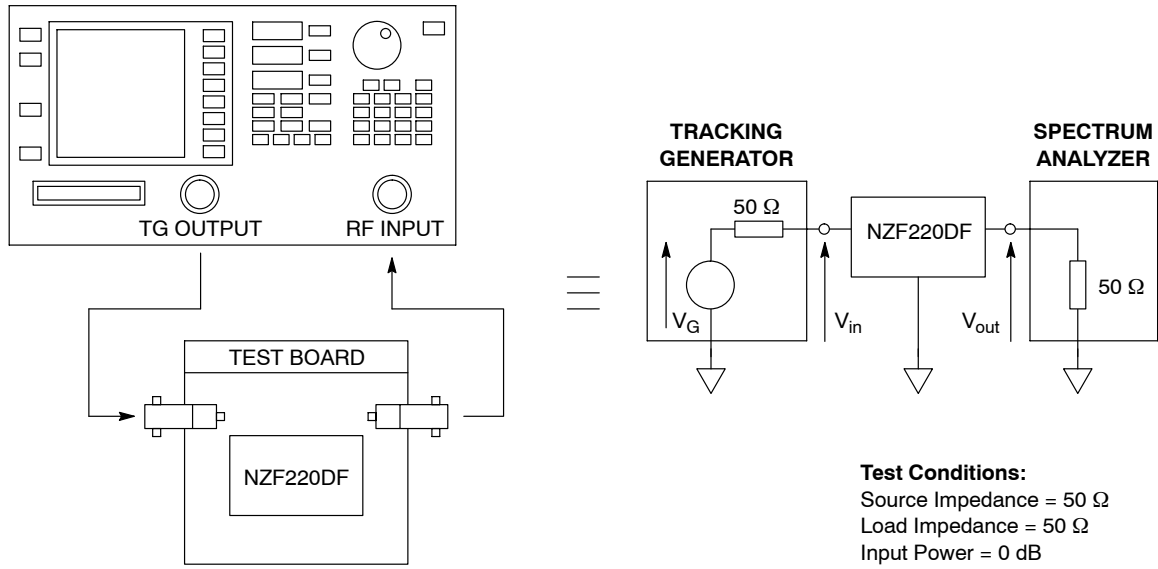

Figure 1. Measurement Conditions

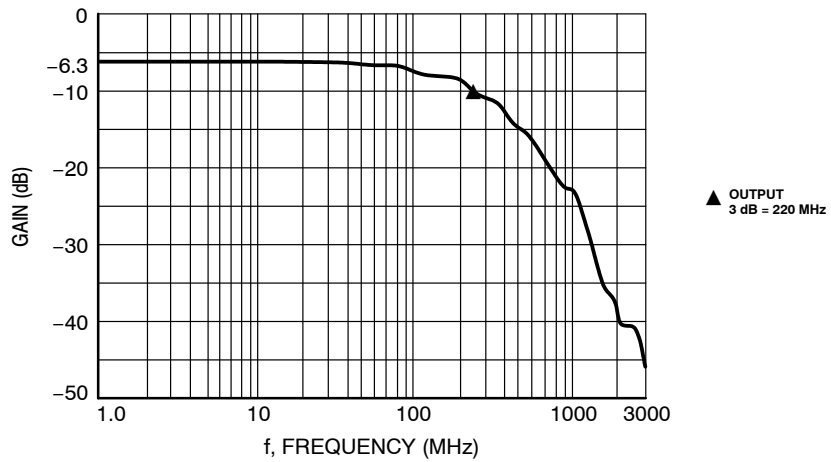

Figure 2. Typical EMI Filter Response  
 (50  $\Omega$  Source and 50  $\Omega$  Lead Termination)

# MECHANICAL CASE OUTLINE PACKAGE DIMENSIONS



SCALE 2:1

## SC-88A (SC-70-5/SOT-353) CASE 419A-02 ISSUE M

DATE 11 APR 2023

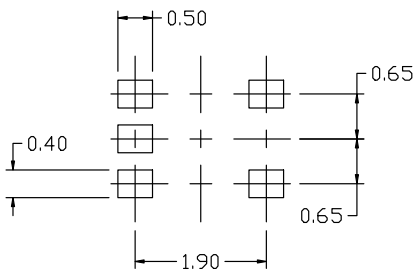
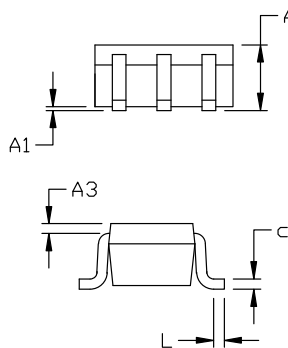

### RECOMMENDED MOUNTING FOOTPRINT

\* For additional information on our Pb-Free strategy and soldering details, please download the ON Semiconductor Soldering and Mounting Techniques Reference Manual, SOLDERM/D.

### NOTES:

1. DIMENSIONING AND TOLERANCING PER ANSI Y14.5M, 1982.
2. CONTROLLING DIMENSION: MILLIMETERS
3. 419A-01 OBSOLETE. NEW STANDARD 419A-02
4. DIMENSIONS D AND E1 DO NOT INCLUDE MOLD FLASH, PROTRUSIONS, OR GATE BURRS. MOLD FLASH, PROTRUSIONS, OR GATE BURRS SHALL NOT EXCEED 0.1016MM PER SIDE.

DIM	MILLIMETERS		
	MIN.	NOM.	MAX.
A	0.80	0.95	1.10
A1	---	---	0.10
A3	0.20 REF		
b	0.10	0.20	0.30
c	0.10	---	0.25
D	1.80	2.00	2.20
E	2.00	2.10	2.20
E1	1.15	1.25	1.35
e	0.65 BSC		
L	0.10	0.15	0.30

### GENERIC MARKING DIAGRAM\*

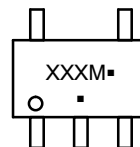

\*This information is generic. Please refer to device data sheet for actual part marking. Pb-Free indicator, "G" or microdot "▪", may or may not be present. Some products may not follow the Generic Marking.

XXX = Specific Device Code

M = Date Code

▪ = Pb-Free Package

(Note: Microdot may be in either location)

#### STYLE 1:

- PIN 1. BASE
- EMITTER
- BASE
- COLLECTOR
- COLLECTOR

#### STYLE 2:

- PIN 1. ANODE
- EMITTER
- BASE
- COLLECTOR
- CATHODE

#### STYLE 3:

- PIN 1. ANODE 1
- N/C
- ANODE 2
- CATHODE 2
- CATHODE 1

#### STYLE 4:

- PIN 1. SOURCE 1
- DRAIN 1/2
- SOURCE 1
- GATE 1
- GATE 2

#### STYLE 5:

- PIN 1. CATHODE
- COMMON ANODE
- CATHODE 2
- CATHODE 3
- CATHODE 4

#### STYLE 6:

- PIN 1. EMITTER 2
- BASE 2
- EMITTER 1
- COLLECTOR
- COLLECTOR 2/BASE 1

#### STYLE 7:

- PIN 1. BASE
- EMITTER
- BASE
- COLLECTOR
- COLLECTOR

#### STYLE 8:

- PIN 1. CATHODE
- COLLECTOR
- N/C
- BASE
- EMITTER

#### STYLE 9:

- PIN 1. ANODE
- CATHODE
- ANODE
- ANODE
- ANODE

Note: Please refer to datasheet for style callout. If style type is not called out in the datasheet refer to the device datasheet pinout or pin assignment.

<b>DOCUMENT NUMBER:</b>	<b>98ASB42984B</b>	Electronic versions are uncontrolled except when accessed directly from the Document Repository. Printed versions are uncontrolled except when stamped "CONTROLLED COPY" in red.
<b>DESCRIPTION:</b>	<b>SC-88A (SC-70-5/SOT-353)</b>	<b>PAGE 1 OF 1</b>

onsemi and ONSEMI are trademarks of Semiconductor Components Industries, LLC dba onsemi or its subsidiaries in the United States and/or other countries. onsemi reserves the right to make changes without further notice to any products herein. onsemi makes no warranty, representation or guarantee regarding the suitability of its products for any particular purpose, nor does onsemi assume any liability arising out of the application or use of any product or circuit, and specifically disclaims any and all liability, including without limitation special, consequential or incidental damages. onsemi does not convey any license under its patent rights nor the rights of others.

**onsemi**, **Onsemi**, and other names, marks, and brands are registered and/or common law trademarks of Semiconductor Components Industries, LLC dba "**onsemi**" or its affiliates and/or subsidiaries in the United States and/or other countries. **onsemi** owns the rights to a number of patents, trademarks, copyrights, trade secrets, and other intellectual property. A listing of **onsemi**'s product/patent coverage may be accessed at [www.onsemi.com/site/pdf/Patent-Marking.pdf](http://www.onsemi.com/site/pdf/Patent-Marking.pdf). **onsemi** reserves the right to make changes at any time to any products or information herein, without notice. The information herein is provided "as-is" and **onsemi** makes no warranty, representation or guarantee regarding the accuracy of the information, product features, availability, functionality, or suitability of its products for any particular purpose, nor does **onsemi** assume any liability arising out of the application or use of any product or circuit, and specifically disclaims any and all liability, including without limitation special, consequential or incidental damages. Buyer is responsible for its products and applications using **onsemi** products, including compliance with all laws, regulations and safety requirements or standards, regardless of any support or applications information provided by **onsemi**. "Typical" parameters which may be provided in **onsemi** data sheets and/or specifications can and do vary in different applications and actual performance may vary over time. All operating parameters, including "Typicals" must be validated for each customer application by customer's technical experts. **onsemi** does not convey any license under any of its intellectual property rights nor the rights of others. **onsemi** products are not designed, intended, or authorized for use as a critical component in life support systems or any FDA Class 3 medical devices or medical devices with a same or similar classification in a foreign jurisdiction or any devices intended for implantation in the human body. Should Buyer purchase or use **onsemi** products for any such unintended or unauthorized application, Buyer shall indemnify and hold **onsemi** and its officers, employees, subsidiaries, affiliates, and distributors harmless against all claims, costs, damages, and expenses, and reasonable attorney fees arising out of, directly or indirectly, any claim of personal injury or death associated with such unintended or unauthorized use, even if such claim alleges that **onsemi** was negligent regarding the design or manufacture of the part. **onsemi** is an Equal Opportunity/Affirmative Action Employer. This literature is subject to all applicable copyright laws and is not for resale in any manner.

## ADDITIONAL INFORMATION

### TECHNICAL PUBLICATIONS:

Technical Library: [www.onsemi.com/design/resources/technical-documentation](http://www.onsemi.com/design/resources/technical-documentation)  
onsemi Website: [www.onsemi.com](http://www.onsemi.com)

### ONLINE SUPPORT: [www.onsemi.com/support](http://www.onsemi.com/support)

For additional information, please contact your local Sales Representative at [www.onsemi.com/support/sales](http://www.onsemi.com/support/sales)