

NPN Power Transistors

2N3773

The 2N3773 is a PowerBase power transistor designed for high power audio, disk head positioners and other linear applications. This device can also be used in power switching circuits such as relay or solenoid drivers, DC-DC converters or inverters.

Features

- High Safe Operating Area (100% Tested) 150 W @ 100 V
- Completely Characterized for Linear Operation
- High DC Current Gain and Low Saturation Voltage
 $h_{FE} = 15 \text{ (Min) @ } 8.0 \text{ A, } 4.0 \text{ V}$
 $V_{CE(sat)} = 1.4 \text{ V (Max) @ } I_C = 8.0 \text{ A, } I_B = 0.8 \text{ A}$
- For Low Distortion Complementary Designs
- This is a Pb-Free Device

MAXIMUM RATINGS (Note 1)

Rating	Symbol	Value	Unit
Collector – Emitter Voltage	V_{CEO}	140	Vdc
Collector – Emitter Voltage	V_{CEX}	160	Vdc
Collector – Base Voltage	V_{CBO}	160	Vdc
Emitter – Base Voltage	V_{EBO}	7	Vdc
Collector Current – Continuous – Peak (Note 2)	I_C	16 30	Adc
Base Current – Continuous – Peak (Note 2)	I_B	4 15	Adc
Total Power Dissipation @ $T_A = 25^\circ\text{C}$ Derate above 25°C	P_D	150 0.855	W W/ $^\circ\text{C}$
Operating and Storage Junction Temperature Range	T_J, T_{stg}	-65 to +200	$^\circ\text{C}$

Stresses exceeding those listed in the Maximum Ratings table may damage the device. If any of these limits are exceeded, device functionality should not be assumed, damage may occur and reliability may be affected.

1. Indicates JEDEC Registered Data.
2. Pulse Test: Pulse Width = 5 ms, Duty Cycle $\leq 10\%$.

THERMAL CHARACTERISTICS

Characteristic	Symbol	Max	Unit
Thermal Resistance, Junction-to-Case	$R_{\theta JC}$	1.17	$^\circ\text{C/W}$

*For additional information on our Pb-Free strategy and soldering details, please download the **onsemi** Soldering and Mounting Techniques Reference Manual, SOLDERRM/D.

16 A NPN POWER TRANSISTORS 140 V, 150 W

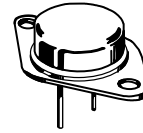

TO-204
CASE 1-07

MARKING DIAGRAM



- A = Assembly Location
- YY = Year
- WW = Work Week
- G = Pb-Free Package

ORDERING INFORMATION

See detailed ordering and shipping information on page 2 of this data sheet.

2N3773

ELECTRICAL CHARACTERISTICS (T_C = 25°C unless otherwise noted)

Characteristic	Symbol	Min	Max	Unit
OFF CHARACTERISTICS (Note 3)				
Collector–Emitter Breakdown Voltage (Note 4) (I _C = 0.2 Adc, I _B = 0)	V _{CEO(sus)}	140	–	Vdc
Collector–Emitter Sustaining Voltage (Note 4) (I _C = 0.1 Adc, V _{BE(off)} = 1.5 Vdc, R _{BE} = 100 Ω)	V _{CEX(sus)}	160	–	Vdc
Collector–Emitter Sustaining Voltage (I _C = 0.2 Adc, R _{BE} = 100 Ω)	V _{CER(sus)}	150	–	Vdc
Collector Cutoff Current (Note 4) (V _{CE} = 120 Vdc, I _B = 0)	I _{CEO}	–	10	mAdc
Collector Cutoff Current (Note 4) (V _{CE} = 140 Vdc, V _{BE(off)} = 1.5 Vdc) (V _{CE} = 140 Vdc, V _{BE(off)} = 1.5 Vdc, T _C = 150°C)	I _{CEX}	–	2 10	mAdc
Collector Cutoff Current (V _{CB} = 140 Vdc, I _E = 0)	I _{CBO}	–	2	mAdc
Emitter Cutoff Current (Note 4) (V _{BE} = 7 Vdc, I _C = 0)	I _{EBO}	–	5	mAdc

ON CHARACTERISTICS

 (Note 3)

DC Current Gain (I _C = 8 Adc, V _{CE} = 4 Vdc) (Note 4) (I _C = 16 Adc, V _{CE} = 4 Vdc)	h _{FE}	15 5	60 –	–
Collector–Emitter Saturation Voltage (I _C = 8 Adc, I _B = 800 mAdc) (Note 4) (I _C = 16 Adc, I _B = 3.2 Adc)	V _{CE(sat)}	– –	1.4 4	Vdc
Base–Emitter On Voltage (Note 4) (I _C = 8 Adc, V _{CE} = 4 Vdc)	V _{BE(on)}	–	2.2	Vdc

DYNAMIC CHARACTERISTICS

Magnitude of Common–Emitter Small–Signal, Short–Circuit, Forward Current Transfer Ratio (I _C = 1 A, f = 50 kHz)	h _{fe}	4	–	–
Small–Signal Current Gain (Note 4) (I _C = 1 Adc, V _{CE} = 4 Vdc, f = 1 kHz)	h _{fe}	40	–	–

SECOND BREAKDOWN CHARACTERISTICS

Second Breakdown Collector Current with Base Forward Biased t = 1 s (non–repetitive), V _{CE} = 100 V, See Figure 12	I _{S/b}	1.5	–	Adc
---	------------------	-----	---	-----

Product parametric performance is indicated in the Electrical Characteristics for the listed test conditions, unless otherwise noted. Product performance may not be indicated by the Electrical Characteristics if operated under different conditions.

3. Pulse Test: Pulse Width = 300 μs, Duty Cycle ≤ 2%.

4. Indicates JEDEC Registered Data.

ORDERING INFORMATION

Device	Package	Shipping [†]
2N3773G	TO–204 (Pb–Free)	100 Unit / Tray

[†]For information on tape and reel specifications, including part orientation and tape sizes, please refer to our Tape and Reel Packaging Specifications Brochure, BRD8011/D.

NPN

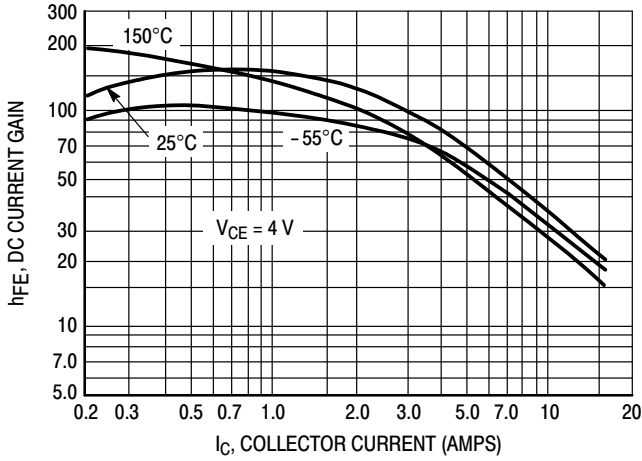

Figure 1. DC Current Gain

PNP

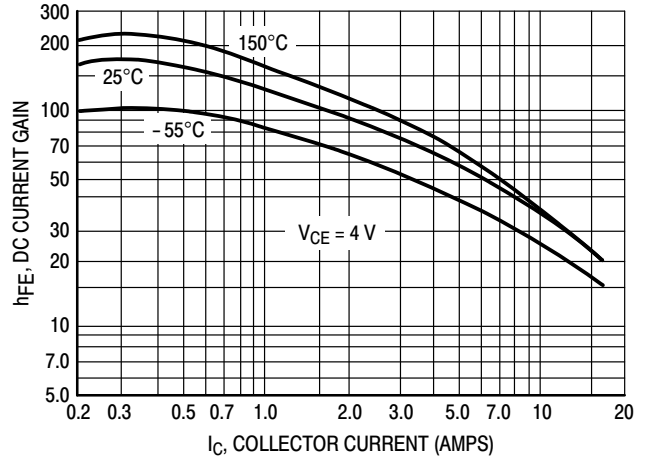

Figure 2. DC Current Gain

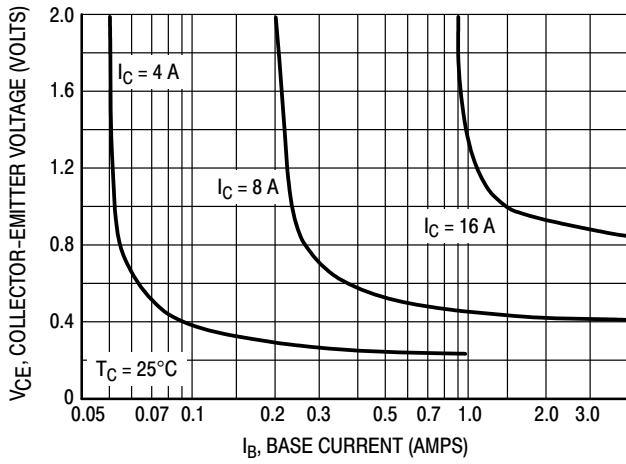

Figure 3. Collector Saturation Region

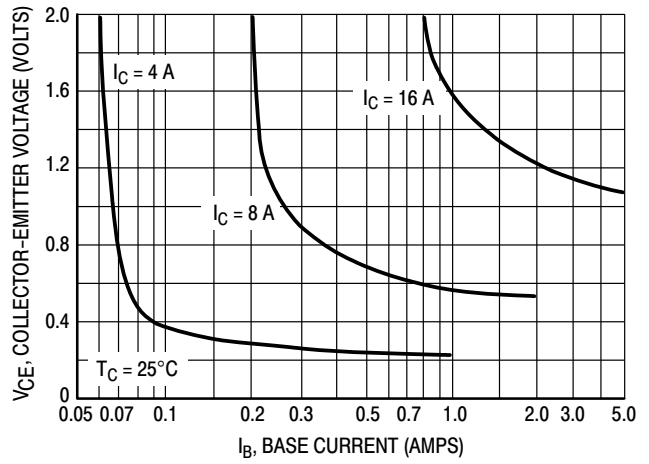

Figure 4. Collector Saturation Region

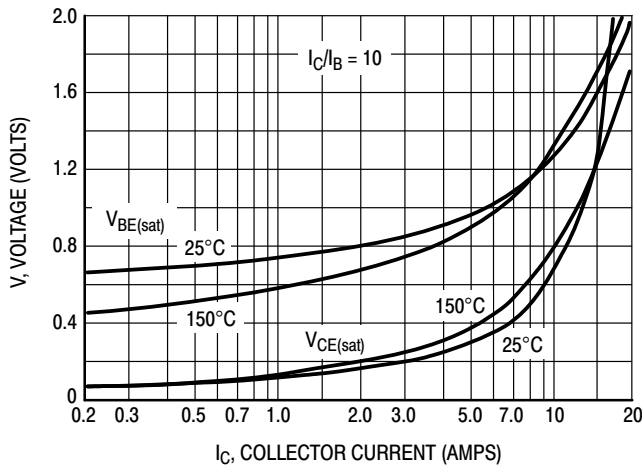

Figure 5. "On" Voltage

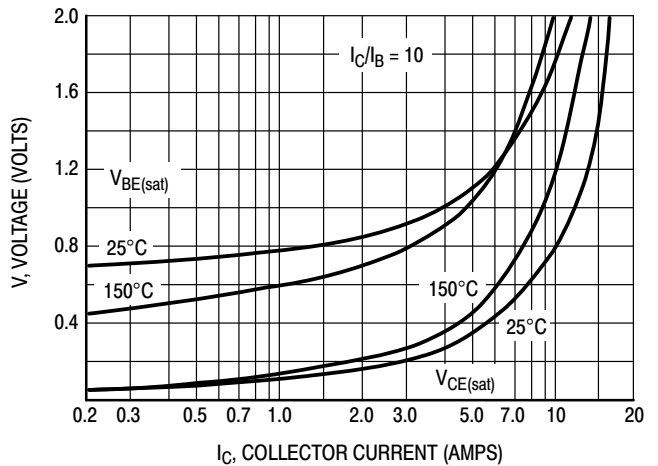

Figure 6. "On" Voltage

TYPICAL CHARACTERISTICS

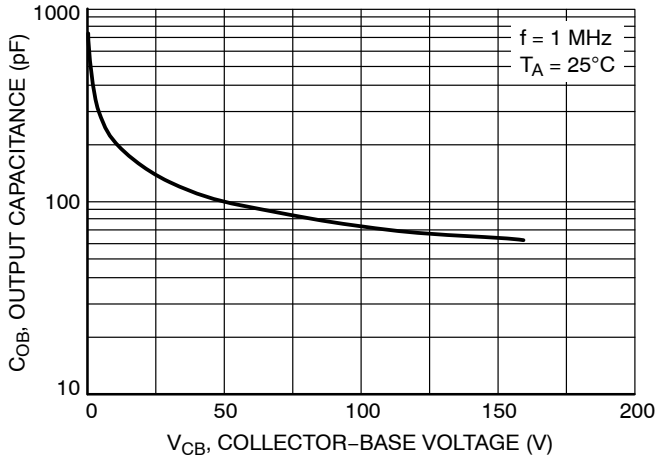

Figure 7. Output Capacitance

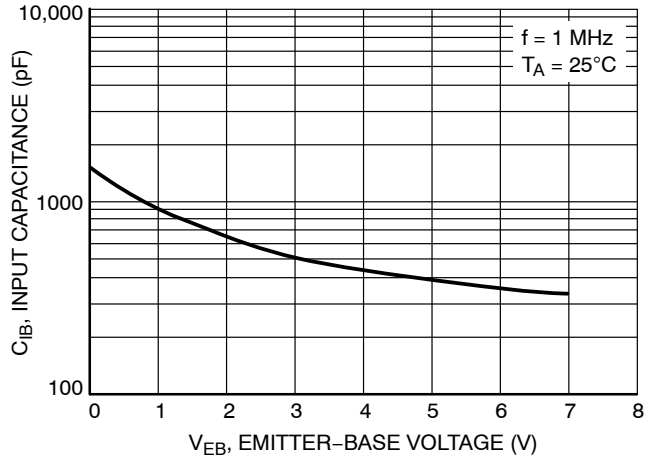

Figure 8. Input Capacitance

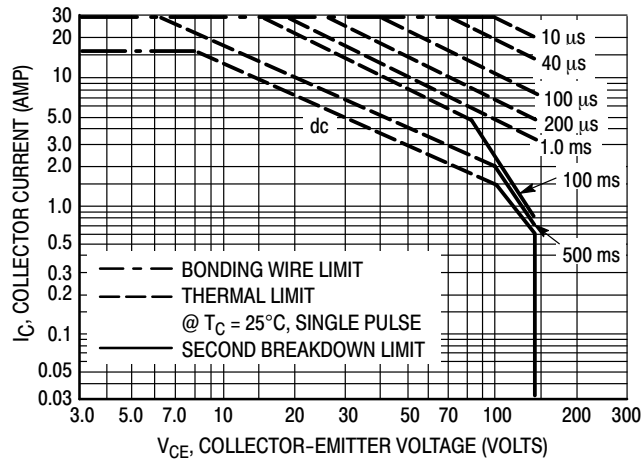

Figure 9. Forward Bias Safe Operating Area

There are two limitations on the power handling ability of a transistor: average junction temperature and second breakdown. Safe operating area curves indicate $I_C - V_{CE}$ limits of the transistor that must be observed for reliable operation: i.e., the transistor must not be subjected to greater dissipation than the curves indicate.

The data of Figure 9 is based on $T_{J(pk)} = 200^\circ\text{C}$; T_C is variable depending on conditions. Second breakdown pulse limits are valid for duty cycles to 10% provided $T_{J(pk)} < 200^\circ\text{C}$. At high case temperatures, thermal limitations will reduce the power that can be handled to values less than the limitations imposed by second breakdown.

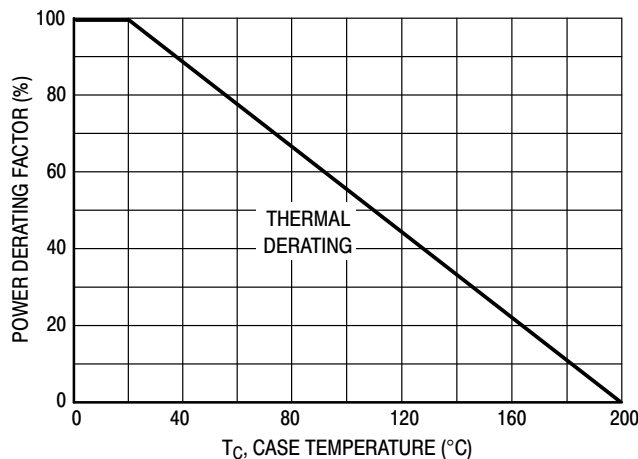
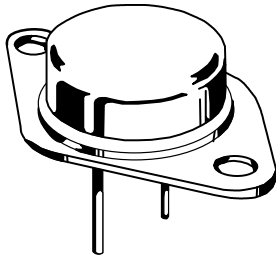

Figure 10. Power Derating



TO-204 (TO-3)
CASE 1-07
ISSUE Z

DATE 10 MAR 2000

SCALE 1:1

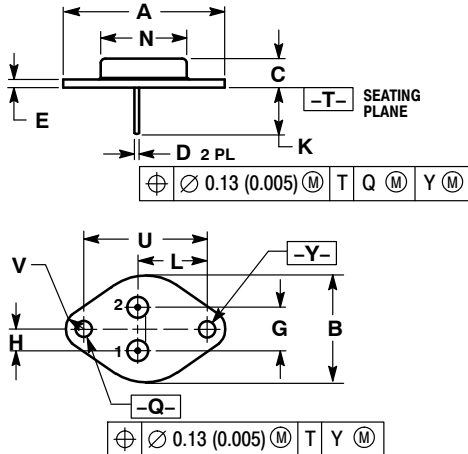

- NOTES:
1. DIMENSIONING AND TOLERANCING PER ANSI Y14.5M, 1982.
 2. CONTROLLING DIMENSION: INCH.
 3. ALL RULES AND NOTES ASSOCIATED WITH REFERENCED TO-204AA OUTLINE SHALL APPLY.

DIM	INCHES		MILLIMETERS	
	MIN	MAX	MIN	MAX
A	1.550 REF		39.37 REF	
B	---	1.050	---	26.67
C	0.250	0.335	6.35	8.51
D	0.038	0.043	0.97	1.09
E	0.055	0.070	1.40	1.77
G	0.430 BSC		10.92 BSC	
H	0.215 BSC		5.46 BSC	
K	0.440	0.480	11.18	12.19
L	0.665 BSC		16.89 BSC	
N	---	0.830	---	21.08
Q	0.151	0.165	3.84	4.19
U	1.187 BSC		30.15 BSC	
V	0.131	0.188	3.33	4.77

- | | | | | |
|--|--|---|---|---|
| <p>STYLE 1:
PIN 1. BASE
2. EMITTER
CASE: COLLECTOR</p> | <p>STYLE 2:
PIN 1. BASE
2. COLLECTOR
CASE: EMITTER</p> | <p>STYLE 3:
PIN 1. GATE
2. SOURCE
CASE: DRAIN</p> | <p>STYLE 4:
PIN 1. GROUND
2. INPUT
CASE: OUTPUT</p> | <p>STYLE 5:
PIN 1. CATHODE
2. EXTERNAL TRIP/DELAY
CASE: ANODE</p> |
| <p>STYLE 6:
PIN 1. GATE
2. EMITTER
CASE: COLLECTOR</p> | <p>STYLE 7:
PIN 1. ANODE
2. OPEN
CASE: CATHODE</p> | <p>STYLE 8:
PIN 1. CATHODE #1
2. CATHODE #2
CASE: ANODE</p> | <p>STYLE 9:
PIN 1. ANODE #1
2. ANODE #2
CASE: CATHODE</p> | |

DOCUMENT NUMBER:	98ASB42001B	Electronic versions are uncontrolled except when accessed directly from the Document Repository. Printed versions are uncontrolled except when stamped "CONTROLLED COPY" in red.
DESCRIPTION:	TO-204 (TO-3)	PAGE 1 OF 1

onsemi and ONSEMI are trademarks of Semiconductor Components Industries, LLC dba onsemi or its subsidiaries in the United States and/or other countries. onsemi reserves the right to make changes without further notice to any products herein. onsemi makes no warranty, representation or guarantee regarding the suitability of its products for any particular purpose, nor does onsemi assume any liability arising out of the application or use of any product or circuit, and specifically disclaims any and all liability, including without limitation special, consequential or incidental damages. onsemi does not convey any license under its patent rights nor the rights of others.

onsemi, **Onsemi**, and other names, marks, and brands are registered and/or common law trademarks of Semiconductor Components Industries, LLC dba "**onsemi**" or its affiliates and/or subsidiaries in the United States and/or other countries. **onsemi** owns the rights to a number of patents, trademarks, copyrights, trade secrets, and other intellectual property. A listing of **onsemi**'s product/patent coverage may be accessed at www.onsemi.com/site/pdf/Patent-Marking.pdf. **onsemi** reserves the right to make changes at any time to any products or information herein, without notice. The information herein is provided "as-is" and **onsemi** makes no warranty, representation or guarantee regarding the accuracy of the information, product features, availability, functionality, or suitability of its products for any particular purpose, nor does **onsemi** assume any liability arising out of the application or use of any product or circuit, and specifically disclaims any and all liability, including without limitation special, consequential or incidental damages. Buyer is responsible for its products and applications using **onsemi** products, including compliance with all laws, regulations and safety requirements or standards, regardless of any support or applications information provided by **onsemi**. "Typical" parameters which may be provided in **onsemi** data sheets and/or specifications can and do vary in different applications and actual performance may vary over time. All operating parameters, including "Typicals" must be validated for each customer application by customer's technical experts. **onsemi** does not convey any license under any of its intellectual property rights nor the rights of others. **onsemi** products are not designed, intended, or authorized for use as a critical component in life support systems or any FDA Class 3 medical devices or medical devices with a same or similar classification in a foreign jurisdiction or any devices intended for implantation in the human body. Should Buyer purchase or use **onsemi** products for any such unintended or unauthorized application, Buyer shall indemnify and hold **onsemi** and its officers, employees, subsidiaries, affiliates, and distributors harmless against all claims, costs, damages, and expenses, and reasonable attorney fees arising out of, directly or indirectly, any claim of personal injury or death associated with such unintended or unauthorized use, even if such claim alleges that **onsemi** was negligent regarding the design or manufacture of the part. **onsemi** is an Equal Opportunity/Affirmative Action Employer. This literature is subject to all applicable copyright laws and is not for resale in any manner.

ADDITIONAL INFORMATION

TECHNICAL PUBLICATIONS:

Technical Library: www.onsemi.com/design/resources/technical-documentation
onsemi Website: www.onsemi.com

ONLINE SUPPORT: www.onsemi.com/support

For additional information, please contact your local Sales Representative at www.onsemi.com/support/sales

