

N-Channel Enhancement Mode Field Effect Transistor

2N7002L

Description

This N-channel enhancement mode field effect transistor is produced using high cell density, trench MOSFET technology. This product minimizes on-state resistance while providing rugged, reliable and fast switching performance. This product is particularly suited for low-voltage, low-current applications such as small servo motor control, power MOSFET gate drivers, logic level translator, high speed line drivers, power management/power supply, and switching applications.

Features

- High Density Cell Design for Low $R_{DS(ON)}$
- Voltage Controlled Small Signal Switch
- Rugged and Reliable
- High Saturation Current Capability
- Very Low Capacitance
- Fast Switching Speed
- This Device is Pb-Free and Halogen Free

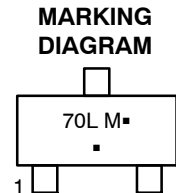
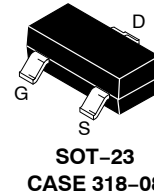
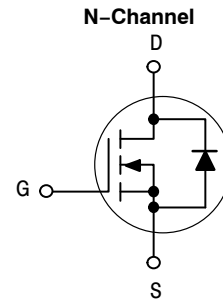

70L = Device Code
M = Date Code*
▪ = Pb-Free Package
(Note: Microdot may be in either location)
*Date Code orientation and/or position may vary depending upon manufacturing location.

ORDERING INFORMATION

Device	Package	Shipping†
2N7002L	SOT-23 (Pb-Free)	3000 / Tape & Reel

†For information on tape and reel specifications, including part orientation and tape sizes, please refer to our Tape and Reel Packaging Specifications Brochure, BRD8011/D.

2N7002L

ABSOLUTE MAXIMUM RATINGS (T_A = 25°C unless otherwise noted)

Symbol	Parameter	Value	Unit
V _{DSS}	Drain–Source Voltage	60	V
V _{DGR}	Drain–Gate Voltage (R _{GS} ≤ 1.0 MΩ)	60	V
V _{GSS}	Gate–Source Voltage – Continuous – Non Repetitive (t _p < 50 μs)	±20 ±40	V
I _D	Maximum Drain Current – Continuous – Pulsed	115 800	mA
T _J , T _{STG}	Operating and Storage Temperature Range	–55 to +150	°C
T _L	Maximum Lead Temperature for Soldering Purposes, 1/16" from Case for 10 Seconds	300	°C

Stresses exceeding those listed in the Maximum Ratings table may damage the device. If any of these limits are exceeded, device functionality should not be assumed, damage may occur and reliability may be affected.

THERMAL CHARACTERISTICS (T_A = 25°C unless otherwise noted) (Note 1)

Symbol	Parameter	Value	Unit
P _D	Maximum Power Dissipation	200	mW
	Derate Above 25°C	1.6	mW/°C
R _{θJA}	Thermal Resistance, Junction–to–Ambient	380	°C/W

ESD RATING (Note 2)

Symbol	Parameter	Value	Unit
HBM	Human Body Model per ANSI/ESDA/JEDEC JS-001-2012	50	V
CDM	Charged Device Model per JEDEC C101C	>2000	V

ELECTRICAL CHARACTERISTICS (T_A = 25°C unless otherwise noted)

Symbol	Parameter	Test Conditions	Min	Typ	Max	Unit
--------	-----------	-----------------	-----	-----	-----	------

OFF CHARACTERISTICS

BV _{DSS}	Drain–Source Breakdown Voltage	V _{GS} = 0 V, I _D = 10 μA	60.0	65.2	–	V
I _{DSS}	Zero Gate Voltage Drain Current	V _{DS} = 60 V, V _{GS} = 0 V	–	0.024	1	μA
		V _{DS} = 60 V, V _{GS} = 0 V, T _J = 125°C	–	0.080	500	
I _{GSSF}	Gate–Body Leakage, Forward	V _{GS} = 20 V, V _{DS} = 0 V	–	0.107	100	nA
I _{GSSR}	Gate–Body Leakage, Reverse	V _{GS} = –20 V, V _{DS} = 0 V	–	–0.037	–100	nA

ON CHARACTERISTICS (Note 3)

V _{GS(th)}	Gate Threshold Voltage	V _{DS} = V _{GS} , I _D = 250 μA	0.80	1.81	2.50	V
R _{DS(on)}	Static Drain–Source On–Resistance	V _{GS} = 10 V, I _D = 500 mA	–	3.35	7.50	Ω
		V _{GS} = 10 V, I _D = 500 mA, T _J = 100°C	–	5.62	13.50	
		V _{GS} = 5 V, I _D = 50 mA	–	2.68	7.50	
		V _{GS} = 5 V, I _D = 50 mA, T _J = 100°C	–	3.97	13.50	
V _{DS(on)}	Drain–Source On–Voltage	V _{GS} = 10 V, I _D = 500 mA	–	1.68	3.75	V
		V _{GS} = 5 V, I _D = 50 mA	–	0.13	1.50	
I _{D(on)}	On–State Drain Current	V _{GS} = 10 V, V _{DS} ≥ 2 V _{DS(on)}	500	557	–	mA
		V _{GS} = 4.5 V, V _{DS} = 10 V	75	571	–	

2N7002L

ELECTRICAL CHARACTERISTICS ($T_A = 25^\circ\text{C}$ unless otherwise noted) (continued)

Symbol	Parameter	Test Conditions	Min	Typ	Max	Unit
--------	-----------	-----------------	-----	-----	-----	------

ON CHARACTERISTICS (Note 3)

g_{FS}	Forward Trans-conductance	$V_{DS} \geq 2 V_{DS(ON)}$, $I_D = 200 \text{ mA}$	80	214	–	mS
----------	---------------------------	---	----	-----	---	----

DYNAMIC CHARACTERISTICS

C_{iss}	Input Capacitance	$V_{DS} = 25 \text{ V}$, $V_{GS} = 0 \text{ V}$, $f = 1.0 \text{ MHz}$	–	12.8	50	pF
C_{oss}	Output Capacitance		–	3.25	25	
C_{rss}	Reverse Transfer Capacitance		–	1.52	5	
R_G	Gate Resistance	$V_{GS} = 0 \text{ V}$, $f = 1.0 \text{ MHz}$	–	22.2	–	Ω

SWITCHING CHARACTERISTICS (Note 3)

t_{on}	Turn-On Time	$V_{DD} = 30 \text{ V}$, $R_L = 150 \Omega$, $I_D = 200 \text{ mA}$, $V_{GS} = 10 \text{ V}$, $R_{GEN} = 25 \Omega$	–	4.35	20	ns
t_{off}	Turn-Off Time		–	15.6	20	ns

DRAIN-SOURCE DIODE CHARACTERISTICS AND MAXIMUM RATINGS

I_S	Maximum Continuous Drain-Source Diode Forward Current		–	–	115	mA
I_{SM}	Maximum Pulsed Drain-Source Diode Forward Current		–	–	0.8	A
V_{SD}	Drain-Source Diode Forward Voltage	$V_{GS} = 0 \text{ V}$, $I_S = 115 \text{ mA}$ (Note 3)	–	0.818	1.5	V

Product parametric performance is indicated in the Electrical Characteristics for the listed test conditions, unless otherwise noted. Product performance may not be indicated by the Electrical Characteristics if operated under different conditions.

- $R_{\theta JA}$ is the sum of the junction-to-case and case-to-ambient thermal resistance where the case thermal reference is defined as the solder mounting surface of the drain pins. $R_{\theta JC}$ is guaranteed by design while $R_{\theta CA}$ is determined by the user's board design.



- 380°C/W when mounted on a minimum pad.

- ESD values are in typical, no over-voltage rating is implied, ESD CDM zap voltage is 2000 V maximum.
- Pulse test: pulse width $\leq 300 \mu\text{s}$, duty cycle $\leq 2.0\%$.

TYPICAL CHARACTERISTICS

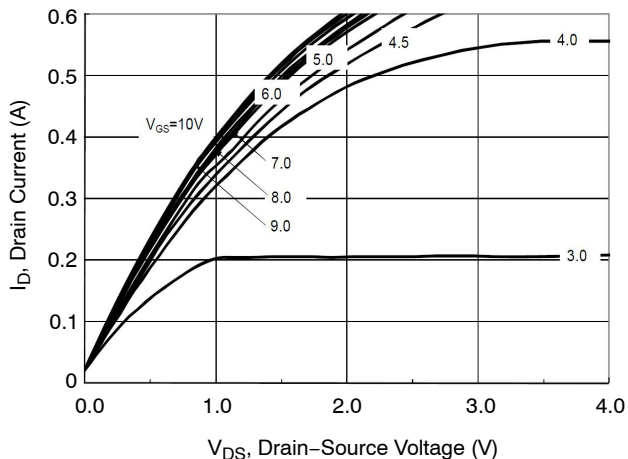

Figure 1. On-Region Characteristics

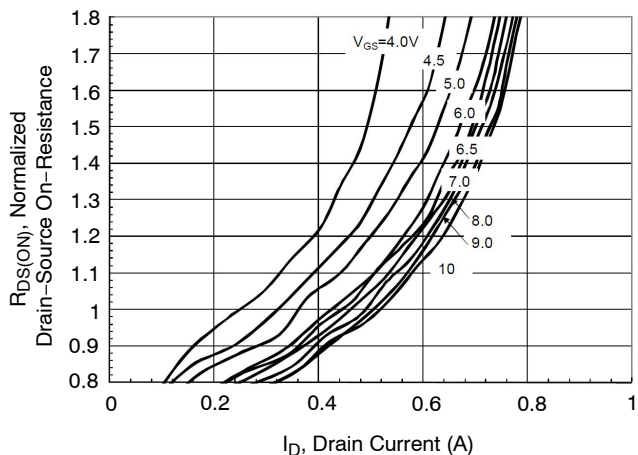

Figure 2. On-Resistance Variation with Gate Voltage and Drain Current

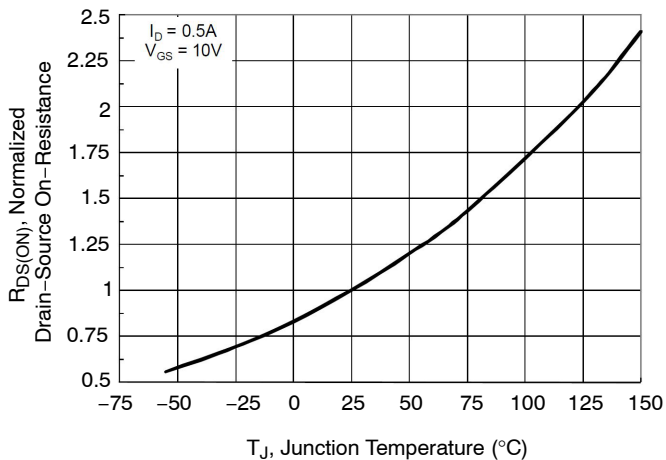

Figure 3. On-Resistance Variation with Temperature

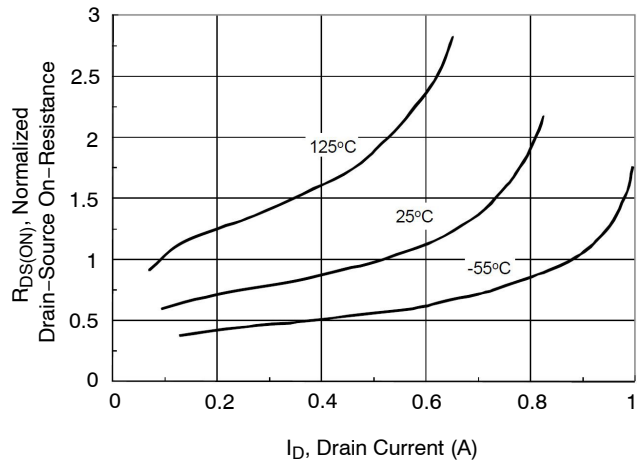

Figure 4. On-Resistance Variation with Drain Current and Temperature

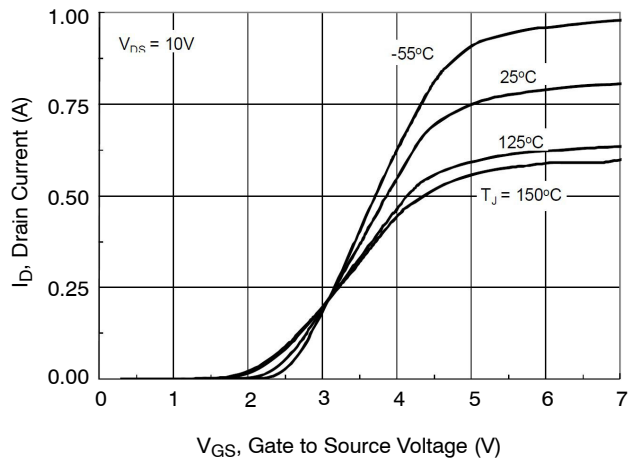

Figure 5. Transfer Characteristics

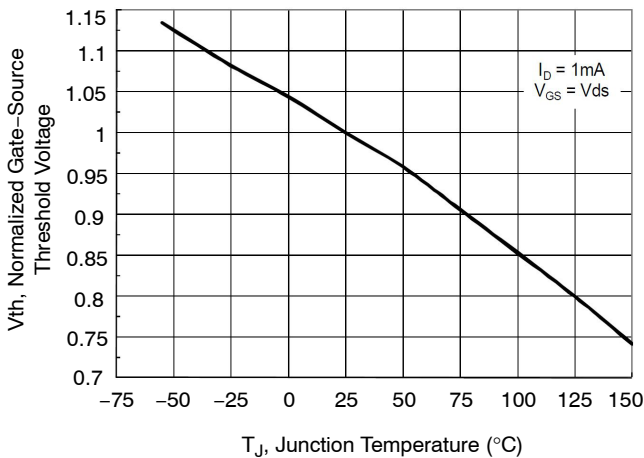

Figure 6. Gate Threshold Variation with Temperature

TYPICAL CHARACTERISTICS (continued)

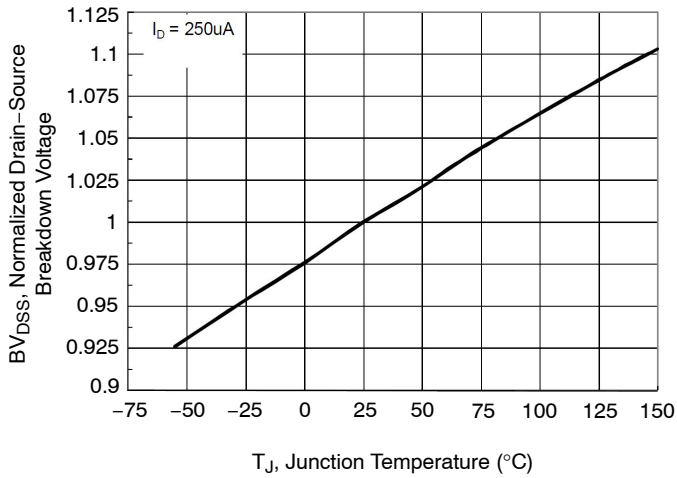

Figure 7. Breakdown Voltage Variation with Temperature

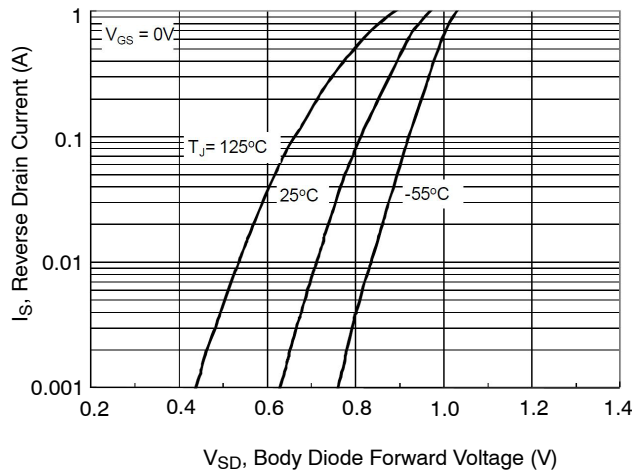

Figure 8. Body Diode Forward Voltage Variation with Source Current and Temperature

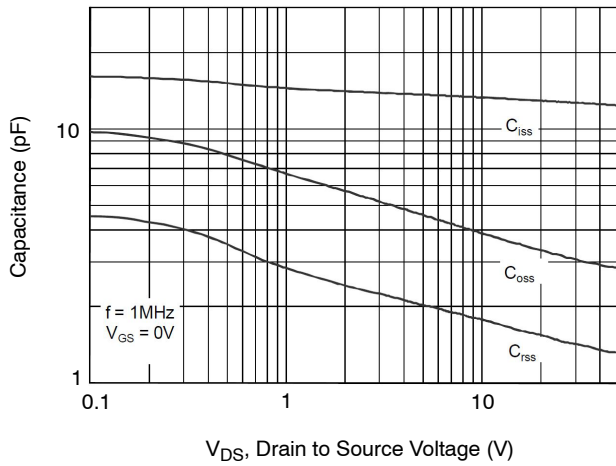

Figure 9. Capacitance Characteristics

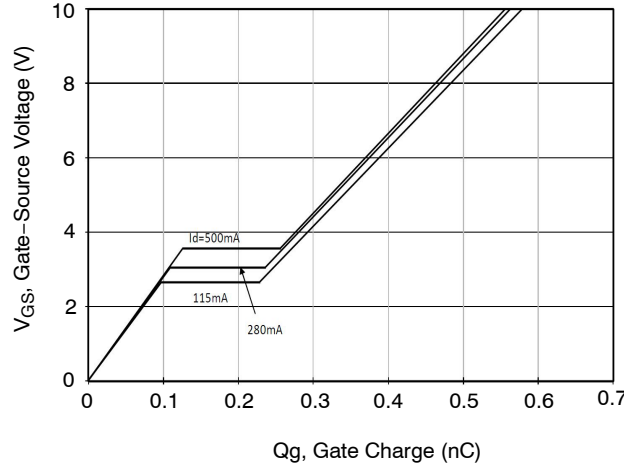

Figure 10. Gate Charge Characteristics

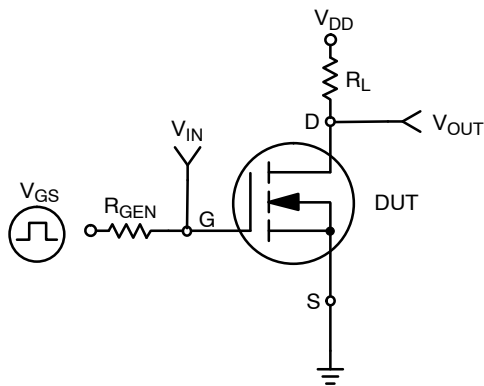

Figure 11.

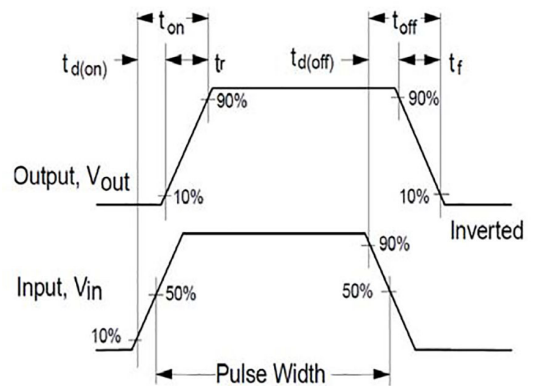

Figure 12. Switching Waveforms

2N7002L

TYPICAL CHARACTERISTICS (continued)

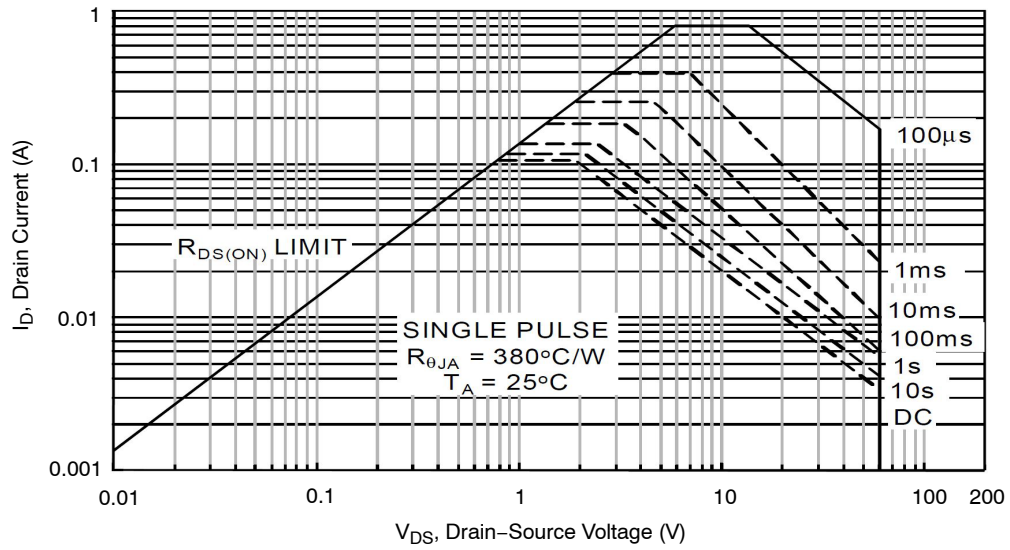

Figure 13. Maximum Safe Operating Area

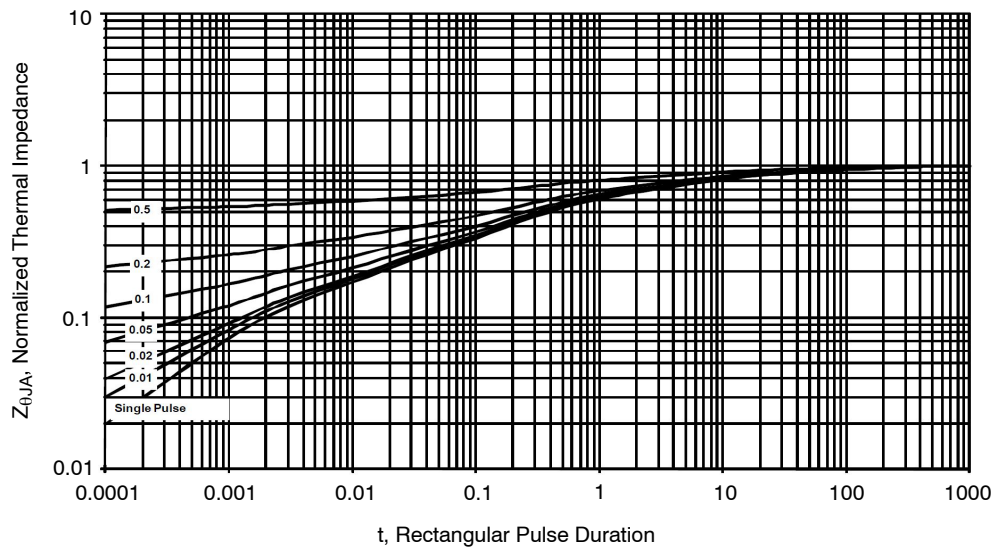

Figure 14. Transient Thermal Response Curve

onsemi, **Onsemi**, and other names, marks, and brands are registered and/or common law trademarks of Semiconductor Components Industries, LLC dba "**onsemi**" or its affiliates and/or subsidiaries in the United States and/or other countries. **onsemi** owns the rights to a number of patents, trademarks, copyrights, trade secrets, and other intellectual property. A listing of **onsemi**'s product/patent coverage may be accessed at www.onsemi.com/site/pdf/Patent-Marking.pdf. **onsemi** reserves the right to make changes at any time to any products or information herein, without notice. The information herein is provided "as-is" and **onsemi** makes no warranty, representation or guarantee regarding the accuracy of the information, product features, availability, functionality, or suitability of its products for any particular purpose, nor does **onsemi** assume any liability arising out of the application or use of any product or circuit, and specifically disclaims any and all liability, including without limitation special, consequential or incidental damages. Buyer is responsible for its products and applications using **onsemi** products, including compliance with all laws, regulations and safety requirements or standards, regardless of any support or applications information provided by **onsemi**. "Typical" parameters which may be provided in **onsemi** data sheets and/or specifications can and do vary in different applications and actual performance may vary over time. All operating parameters, including "Typicals" must be validated for each customer application by customer's technical experts. **onsemi** does not convey any license under any of its intellectual property rights nor the rights of others. **onsemi** products are not designed, intended, or authorized for use as a critical component in life support systems or any FDA Class 3 medical devices or medical devices with a same or similar classification in a foreign jurisdiction or any devices intended for implantation in the human body. Should Buyer purchase or use **onsemi** products for any such unintended or unauthorized application, Buyer shall indemnify and hold **onsemi** and its officers, employees, subsidiaries, affiliates, and distributors harmless against all claims, costs, damages, and expenses, and reasonable attorney fees arising out of, directly or indirectly, any claim of personal injury or death associated with such unintended or unauthorized use, even if such claim alleges that **onsemi** was negligent regarding the design or manufacture of the part. **onsemi** is an Equal Opportunity/Affirmative Action Employer. This literature is subject to all applicable copyright laws and is not for resale in any manner.

ADDITIONAL INFORMATION

TECHNICAL PUBLICATIONS:

Technical Library: www.onsemi.com/design/resources/technical-documentation
onsemi Website: www.onsemi.com

ONLINE SUPPORT: www.onsemi.com/support

For additional information, please contact your local Sales Representative at www.onsemi.com/support/sales