

Small Signal Diode

BAS31

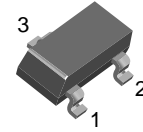

SOT-23
CASE 318BM

ABSOLUTE MAXIMUM RATINGS ($T_A = 25^\circ\text{C}$, unless otherwise noted)
(Note 1, 2)

Symbol	Parameter	Ratings	Unit	
V_{RRM}	Maximum Repetitive Reverse Voltage	120	V	
$I_{F(AV)}$	Average Rectified Forward Current	200	mA	
I_{FSM}	Non-Repetitive Peak Forward Surge Current	Pulse Width = 1.0 second	1.0	A
		Pulse Width = 1.0 microsecond	2.0	
T_{STG}	Storage Temperature Range	-55 to +150	$^\circ\text{C}$	
T_J	Operating Junction Temperature	150	$^\circ\text{C}$	

Stresses exceeding those listed in the Maximum Ratings table may damage the device. If any of these limits are exceeded, device functionality should not be assumed, damage may occur and reliability may be affected.

1. These ratings are based on a maximum junction temperature of 150°C .
2. These are steady-state limits. onsemi should be consulted on applications involving pulsed or low-duty-cycle operations.

THERMAL CHARACTERISTICS ($T_A = 25^\circ\text{C}$, unless otherwise noted)

Symbol	Parameter	Ratings	Unit
P_D	Power Dissipation	350	$^\circ\text{C}/\text{W}$
$R_{\theta JA}$	Thermal Resistance, Junction-to-Ambient	357	

MARKING DIAGRAM

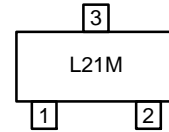

L21 = Specific Device Code
M = Date Code

CONNECTION DIAGRAM

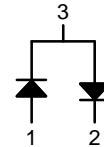

ORDERING INFORMATION

Device	Package	Reel	Shipping†
BAS31	SOT-23 3L (Pb-Free, Halide Free)	7"	3000 / Tape & Reel
BAS31-D87Z		13"	10000 / Tape & Reel

†For information on tape and reel specifications, including part orientation and tape sizes, please refer to our Tape and Reel Packaging Specifications Brochure, [BRD8011/D](#).

ELECTRICAL CHARACTERISTICS ($T_J = 25^\circ\text{C}$ unless otherwise noted)

Symbol	Parameter	Conditions	Min	Max	Unit
V_R	Breakdown Voltage	$I_R = 1.0 \text{ mA}$	120	-	V
V_F	Forward Voltage	$I_F = 10 \text{ mA}$	-	750	mV
		$I_F = 50 \text{ mA}$	-	840	mV
		$I_F = 100 \text{ mA}$	-	900	mV
		$I_F = 200 \text{ mA}$	-	1.00	V
		$I_F = 400 \text{ mA}$	-	1.25	V
I_R	Reverse Current	$V_R = 90 \text{ V}$	-	100	nA
		$V_R = 90 \text{ V}, T_A = 150^\circ\text{C}$	-	100	μA
C_T	Total Capacitance	$V_R = 0 \text{ V}, f = 1.0 \text{ MHz}$	-	35	pF
t_{rr}	Reverse Recovery Time	$I_F = I_R = 30 \text{ mA}, I_{RR} = 3.0 \text{ mA}, R_L = 100 \Omega$	-	50	ns

Product parametric performance is indicated in the Electrical Characteristics for the listed test conditions, unless otherwise noted. Product performance may not be indicated by the Electrical Characteristics if operated under different conditions.

TYPICAL PERFORMANCE CHARACTERISTICS

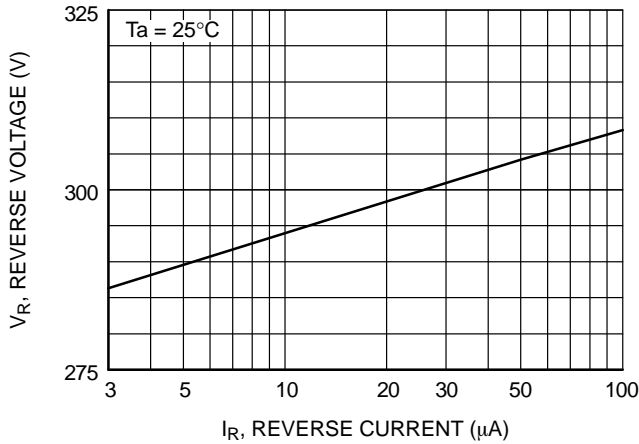
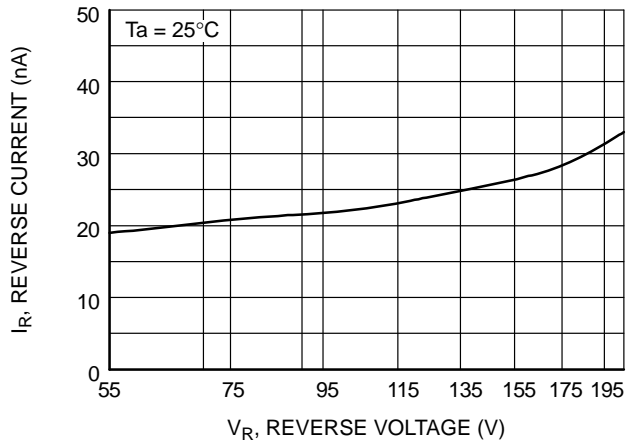
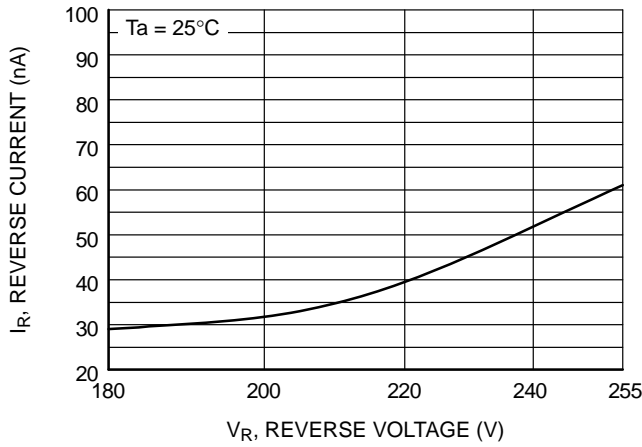

Figure 1. Reverse Voltage vs. Reverse Current BV – 1.0 to 100 μ A



GENERAL RULE: The Reverse Current of a diode will approximately double for every ten (10) Degree C increase in Temperature

Figure 2. Reverse Current vs. Reverse Voltage I_R – 55 to 205 V



GENERAL RULE: The Reverse Current of a diode will approximately double for every ten (10) Degree C increase in Temperature

Figure 3. Reverse Current vs. Reverse Voltage I_R – 180 to 255 V

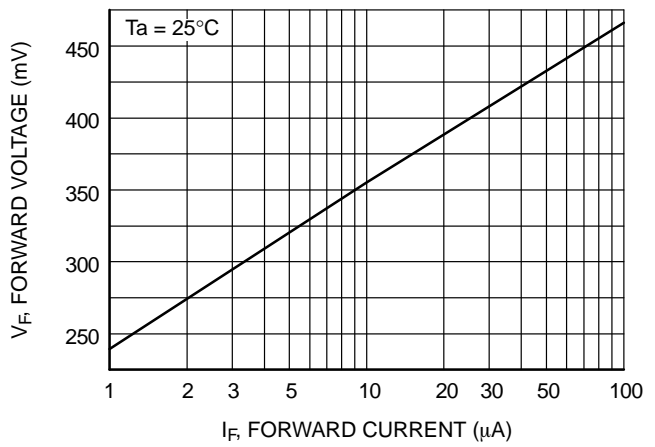

Figure 4. Forward Voltage vs. Forward Current V_F – 1.0 to 100 μ A

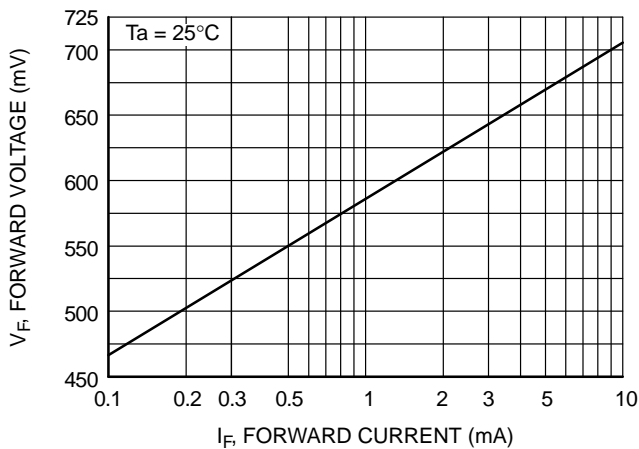

Figure 5. Forward Voltage vs. Forward Current V_F – 0.1 to 10 mA

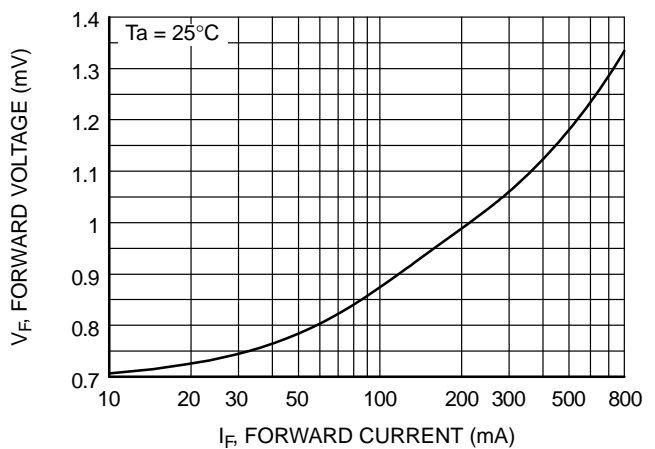

Figure 6. Forward Voltage vs. Forward Current V_F – 10 to 800 mA

BAS31

TYPICAL PERFORMANCE CHARACTERISTICS (CONTINUED)

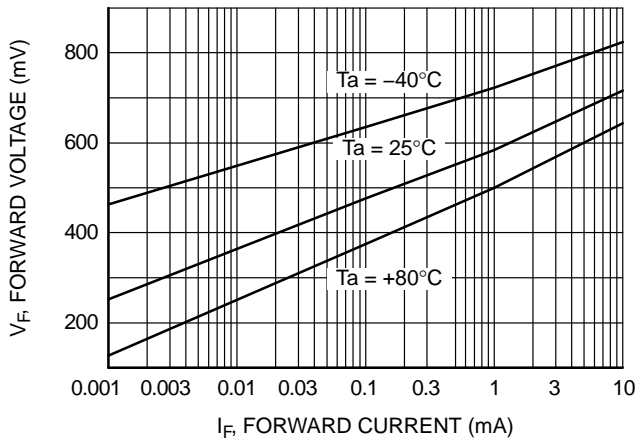

Figure 7. Forward Voltage vs. Ambient Temperature
VF – 1.0 μ A – 10 mA (– 40 to +80°C)

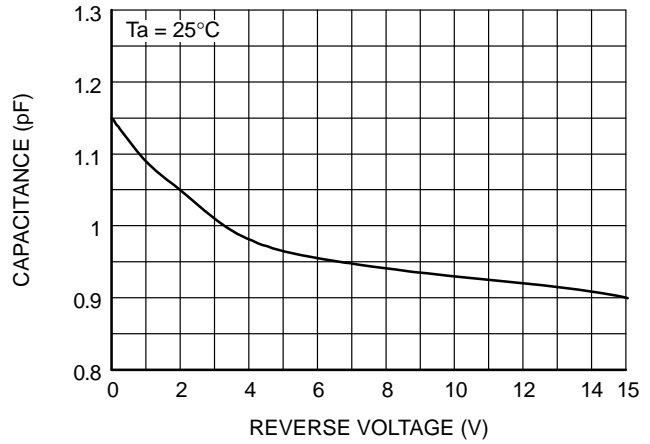

Figure 8. Capacitance vs. Reverse Voltage

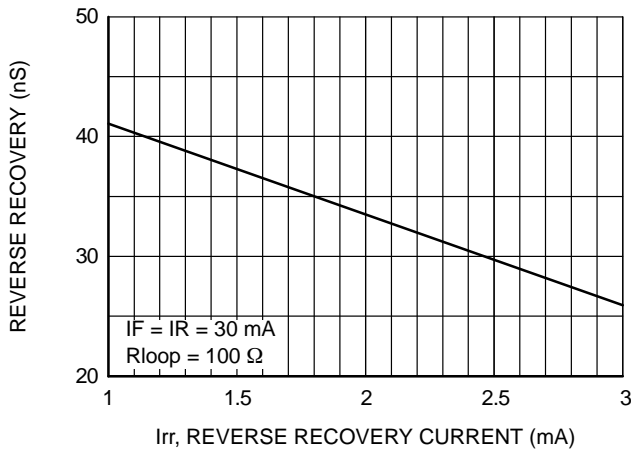

Figure 9. Reverse Recovery Time vs. Reverse Recovery Current (Irr)

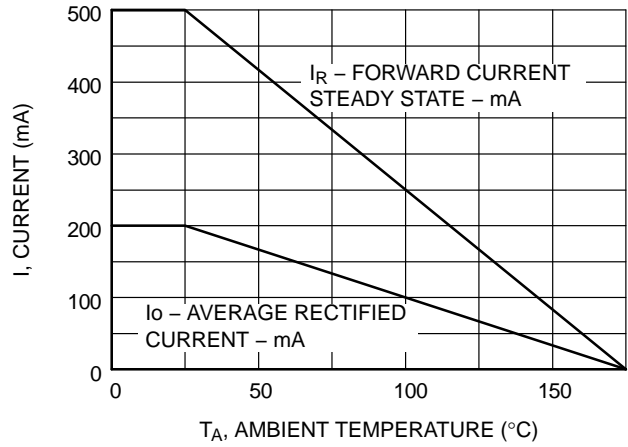

Figure 10. Average Rectified Current (I_O) and Forward Current (I_F) vs. Ambient Temperature (T_A)

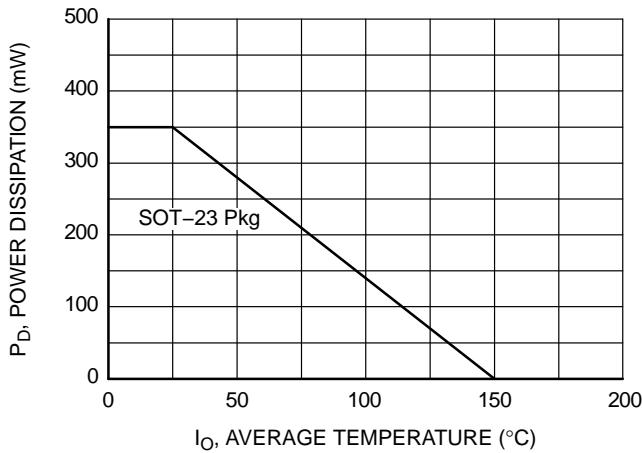

Figure 11. Power Derating Curve

MECHANICAL CASE OUTLINE PACKAGE DIMENSIONS



SOT-23
CASE 318BM
ISSUE A

DATE 01 SEP 2021

NOTES: UNLESS OTHERWISE SPECIFIED

- A) REFERENCE JEDEC REGISTRATION TO-236, VARIATION AB, ISSUE H.
- B) ALL DIMENSIONS ARE IN MILLIMETERS.
- C) DIMENSIONS ARE INCLUSIVE OF BURRS, MOLD FLASH AND TIE BAR EXTRUSIONS.
- D) DIMENSIONING AND TOLERANCING PER ASME Y14.5M - 2009.

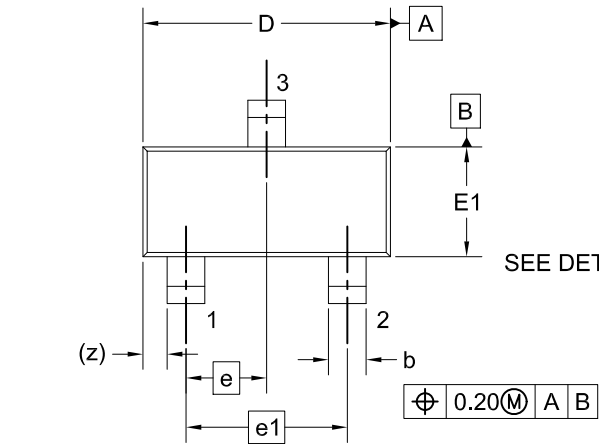

SEE DETAIL A

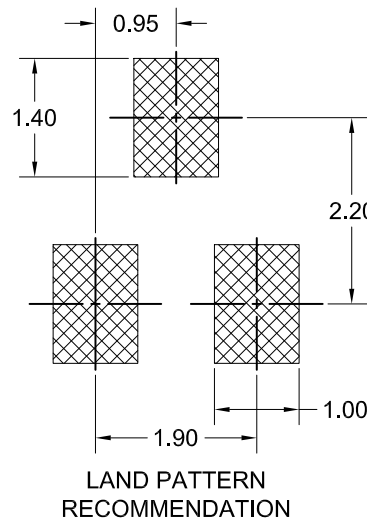
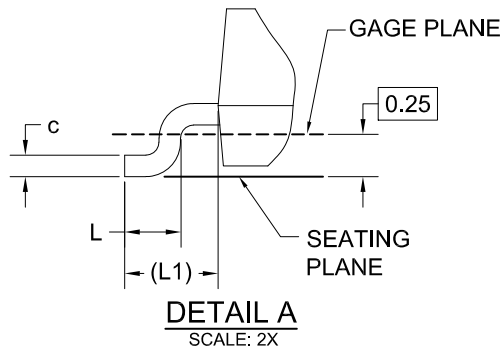
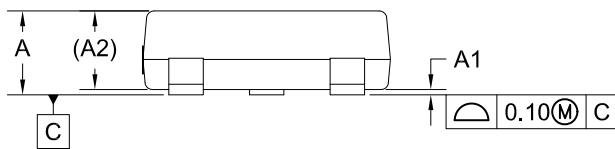
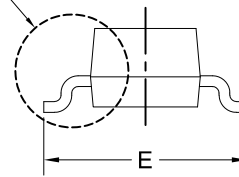

DIM	MILLIMETERS		
	MIN.	NOM.	MAX.
A	---	---	1.20
A1	0.00	0.05	0.10
A2	0.93 REF		
b	0.37	0.44	0.60
c	0.08	0.15	0.23
D	2.72	2.92	3.12
E	2.10	2.40	2.70
E1	1.15	1.30	1.50
e	0.95 BSC		
e1	1.90 BSC		
L	0.20	---	---
L1	0.55 REF		
z	0.29 REF		

GENERIC MARKING DIAGRAM*

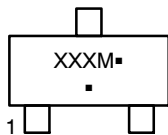

- XXX = Specific Device Code
- M = Date Code
- = Pb-Free Package

*This information is generic. Please refer to device data sheet for actual part marking. Pb-Free indicator, "G" or microdot "▪", may or may not be present. Some products may not follow the Generic Marking.

*FOR ADDITIONAL INFORMATION ON OUR PB-FREE STRATEGY AND SOLDERING DETAILS, PLEASE DOWNLOAD THE ON SEMICONDUCTOR SOLDERING AND MOUNTING TECHNIQUES REFERENCE MANUAL, SOLDERRM/D.

DOCUMENT NUMBER:	98AON13784G	Electronic versions are uncontrolled except when accessed directly from the Document Repository. Printed versions are uncontrolled except when stamped "CONTROLLED COPY" in red.
DESCRIPTION:	SOT-23	PAGE 1 OF 1

onsemi and ONSEMI are trademarks of Semiconductor Components Industries, LLC dba onsemi or its subsidiaries in the United States and/or other countries. onsemi reserves the right to make changes without further notice to any products herein. onsemi makes no warranty, representation or guarantee regarding the suitability of its products for any particular purpose, nor does onsemi assume any liability arising out of the application or use of any product or circuit, and specifically disclaims any and all liability, including without limitation special, consequential or incidental damages. onsemi does not convey any license under its patent rights nor the rights of others.

onsemi, **Onsemi**, and other names, marks, and brands are registered and/or common law trademarks of Semiconductor Components Industries, LLC dba "**onsemi**" or its affiliates and/or subsidiaries in the United States and/or other countries. **onsemi** owns the rights to a number of patents, trademarks, copyrights, trade secrets, and other intellectual property. A listing of **onsemi**'s product/patent coverage may be accessed at www.onsemi.com/site/pdf/Patent-Marking.pdf. **onsemi** reserves the right to make changes at any time to any products or information herein, without notice. The information herein is provided "as-is" and **onsemi** makes no warranty, representation or guarantee regarding the accuracy of the information, product features, availability, functionality, or suitability of its products for any particular purpose, nor does **onsemi** assume any liability arising out of the application or use of any product or circuit, and specifically disclaims any and all liability, including without limitation special, consequential or incidental damages. Buyer is responsible for its products and applications using **onsemi** products, including compliance with all laws, regulations and safety requirements or standards, regardless of any support or applications information provided by **onsemi**. "Typical" parameters which may be provided in **onsemi** data sheets and/or specifications can and do vary in different applications and actual performance may vary over time. All operating parameters, including "Typicals" must be validated for each customer application by customer's technical experts. **onsemi** does not convey any license under any of its intellectual property rights nor the rights of others. **onsemi** products are not designed, intended, or authorized for use as a critical component in life support systems or any FDA Class 3 medical devices or medical devices with a same or similar classification in a foreign jurisdiction or any devices intended for implantation in the human body. Should Buyer purchase or use **onsemi** products for any such unintended or unauthorized application, Buyer shall indemnify and hold **onsemi** and its officers, employees, subsidiaries, affiliates, and distributors harmless against all claims, costs, damages, and expenses, and reasonable attorney fees arising out of, directly or indirectly, any claim of personal injury or death associated with such unintended or unauthorized use, even if such claim alleges that **onsemi** was negligent regarding the design or manufacture of the part. **onsemi** is an Equal Opportunity/Affirmative Action Employer. This literature is subject to all applicable copyright laws and is not for resale in any manner.

ADDITIONAL INFORMATION

TECHNICAL PUBLICATIONS:

Technical Library: www.onsemi.com/design/resources/technical-documentation
onsemi Website: www.onsemi.com

ONLINE SUPPORT: www.onsemi.com/support

For additional information, please contact your local Sales Representative at www.onsemi.com/support/sales