

CAT3224

LED Driver, Charge Pump, 2-Channel

Description

The CAT3224 is a very high-current integrated flash LED driver which also supports the charging function for a dual-cell supercapacitor applications. Ideal for Li-ion battery-powered systems, it delivers up to 4 A LED flash pulses, far beyond the peak current capability of the battery.

Dual-mode 1x/2x charge pump charges the stacked supercapacitor to a nominal voltage of 5.4 V, while an active balance control circuit ensures that both capacitor cell voltages remain matched. The nominal charging current to be drawn from the battery is set by an external resistor tied to the RC pin.

The driver also features two matched current sources. External resistors provide the adjustment for the maximum flash mode current (up to 4 A) and the torch mode current (up to 400 mA). A built-in safety timer automatically terminates the flash pulse beyond a maximum duration of 300 ms.

In addition to thermal shutdown and overvoltage protection, the device is fully protected against external resistor programming faults and fully supports reverse output voltage for all conditions.

The device is packaged in the tiny 16-pad TQFN 3 mm x 3mm package with a max height of 0.8 mm.

Features

- 2 Channels at 2 A Each in Flash Mode
- 2 Channels at 200 mA Each in Torch Mode
- Adjustable Charge Current Limit up to 1000 mA
- Flash/Torch Current Separate Adjustment
- Dual-mode 1x/2x Charge Pump
- Dual Cell Supercapacitor Balancing
- Flash Safety Timer and Ready Flag
- Supercapacitor Continuous Charging
- Shutdown CAP Leakage 3 μ A
- “Zero” Current Shutdown Mode
- 80 μ A Standby Current (I_{VIN})
- Over-voltage, Over-current Limiting
- Thermal Shutdown Protection
- Small 3 mm x 3 mm, 16-pad TQFN Package
- This Device is Pb-Free, Halogen Free/BFR Free and RoHS Compliant

Applications

- High Power LED Flash
- Systems with High Peak Loads



ON Semiconductor®

<http://onsemi.com>



TQFN-16
HV3 SUFFIX
CASE 510AD

PIN CONNECTIONS

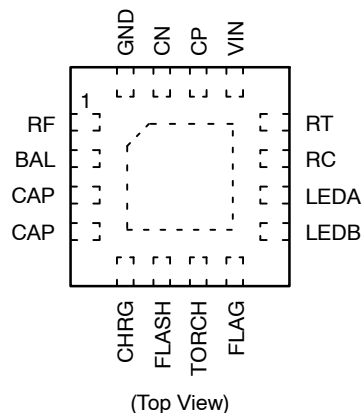

MARKING DIAGRAM



JAAT = Specific Device Code

ORDERING INFORMATION

Device	Package	Shipping
CAT3224HV3-GT2	TQFN-16 (Pb-Free)	2,000/ Tape & Reel

Note: NiPdAu Plated Finish (RoHS-compliant)

CAT3224

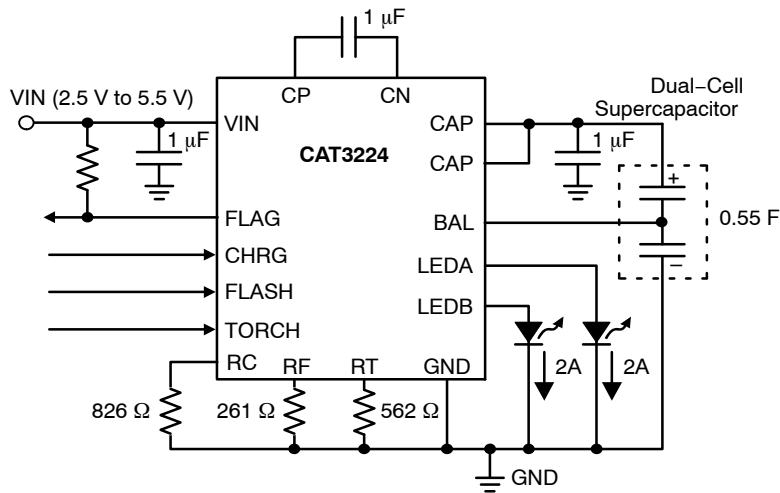

Figure 1. Typical Application Circuit

Table 1. ABSOLUTE MAXIMUM RATINGS

Parameter	Rating	Unit
VIN, RC, RF, RT voltage	GND-0.3 to 6	V
CAP, CP, CN voltage	GND-0.3 to 7	V
CHRG, FLASH, TORCH, FLAG voltage (Note 1)	GND-0.3 to 6	V
BAL, LEDA, LEDB	GND-0.3 to CAP+0.3	V
Storage Temperature Range	-65 to +160	°C
Junction Temperature Range	-40 to +150	°C
Lead Temperature	300	°C
ESD Rating HBM (Human Body Model)	2000	V
ESD Rating MM (Machine Model)	200	V

Stresses exceeding Maximum Ratings may damage the device. Maximum Ratings are stress ratings only. Functional operation above the Recommended Operating Conditions is not implied. Extended exposure to stresses above the Recommended Operating Conditions may affect device reliability.

Table 2. RECOMMENDED OPERATING CONDITIONS

Parameter	Rating	Unit
VIN	2.0 to 5.5	V
Ambient Temperature Range	-40 to +85	°C
LEDA, LEDB current (in flash mode)	up to 2	A
LEDA, LEDB current (in torch mode)	10 to 200	mA
Input Current Limit	up to 1	A
FLAG pull-up resistor current	0 to 10	mA
LED Forward Voltage Range (Vf)	1.3 to 4.2	V

Table 3. PACKAGE THERMAL IMPEDANCE

Parameter	Range	Unit
TQFN 3 mm x 3 mm 16-Lead θ_{JA} (Note 2)	42	°C/W

Table 4. PACKAGE TRANSIENT THERMAL IMPEDANCE

Parameter	Range	Unit
TQFN 3 mm x 3 mm 16-Lead Transient θ_{JA} (Note 3) (100 ms pulse)	7	°C/W

1. Pins can be driven above VIN with no leakage current or change in operation.
2. θ_{JA} (Junction to Ambient thermal resistance) is calculated with 2 square inches of copper connected to package exposed pad.
3. Transient θ_{JA} is calculated for a 100 ms pulse at 5 watts with 2 square inches of copper connected to package exposed pad.

CAT3224

Table 5. ELECTRICAL OPERATING CHARACTERISTICS ($V_{IN} = 3.6\text{ V}$, $EN = 1.3\text{ V}$, $T_{AMB} = 25^{\circ}\text{C}$ unless otherwise stated.)

Symbol	Name	Conditions	Min	Typ	Max	Units
I_{QVIN}	Quiescent Current on VIN pin ($I_{IN} - 2 \times I_{OUT}$)	CAP Charged & idle		80		μA
		CAP Charging 2x Mode		6		mA
I_{QCAP}	Quiescent Current on CAP pin	CAP Charged & idle		10		μA
		Shutdown mode		3		μA
		Shutdown, $V_{IN} = 0\text{ V}$		3		μA
I_{QSHDN}	Shutdown Current	CHRG = FLASH = TORCH = 0 V			1	μA
G_{FLASH}	Flash Gain (I_{FLASH} / I_{RF})	$I_{FLASH} = 2\text{ A}$		900		
G_{TORCH}	Torch Gain (I_{TORCH} / I_{RT})	$I_{TORCH} = 200\text{ mA}$		120		
G_{CHARGE}	Input Current Limit Gain (I_{CHRG} / I_{RC})	$I_{CHARGE} = 400\text{ mA}$		400		
V_{RX}	RSET Regulated Voltage ($V_{RF} V_{RT} V_{RC}$)	$I_{RX} = 0.1\text{ mA}$	0.59	0.6	0.61	V
I_{RX_MAX}	Rset Current limit ($I_{RF} I_{RT} I_{RC}$)	$V_{RX} = 0\text{ V}$		3.5		mA
I_{IN_MAX}	Input current limit in charge mode	$V_{RC} = 0\text{ V}$		1.4		A
V_{C_OFF}	CAP Charge off voltage	$R_C = 2\text{ k}\Omega$		5.4		V
V_{C_HYST}	CAP Charge Hysteresis			0.2		V
V_{F_ON}	CAP voltage FLAG pulled low			5.2		V
V_{F_HYST}	CAP voltage FLAG Hysteresis			0.2		V
R_{LEDAB}	LEDA/B Combined Dropout Resistance	$I_{FLASHAB} = 4\text{ A}$		110		$\text{m}\Omega$
R_{CP}	Charge Mode Resistance	1x mode		2		Ω
		2x mode, $V_{IN} = 3.5\text{ V}$		4		Ω
F_{OSC}	Charge Pump Frequency			800		kHz
T_{FLASH}	Flash Timeout Duration			300		ms
V_{FLAG}	Flag low voltage threshold (Open Drain)	FLAG Driven low 100 μA pull-up			0.2	V
R_{EN} V_{EHI} V_{ELO}	CHRG, FLASH, TORCH Pin Internal Pull-down Resistor Logic High Level Logic Low Level		1.3	150	0.4	$\text{k}\Omega$ V V
V_{BAL}	Active Balance Control ($V_{CAP} / 2$)	$\pm 5\text{ mA}$ Load on BAL	-2		+2	%
T_{SD}	Thermal Shutdown			150		$^{\circ}\text{C}$
T_{HYS}	Thermal Hysteresis			20		$^{\circ}\text{C}$
V_{UVLO}	Undervoltage lockout (UVLO) threshold			1.9		V

Cap Voltage and Flag Output

The timing diagram in Figure 2 shows the CAP output voltage and the FLAG output in charge mode (with CHRG input high).

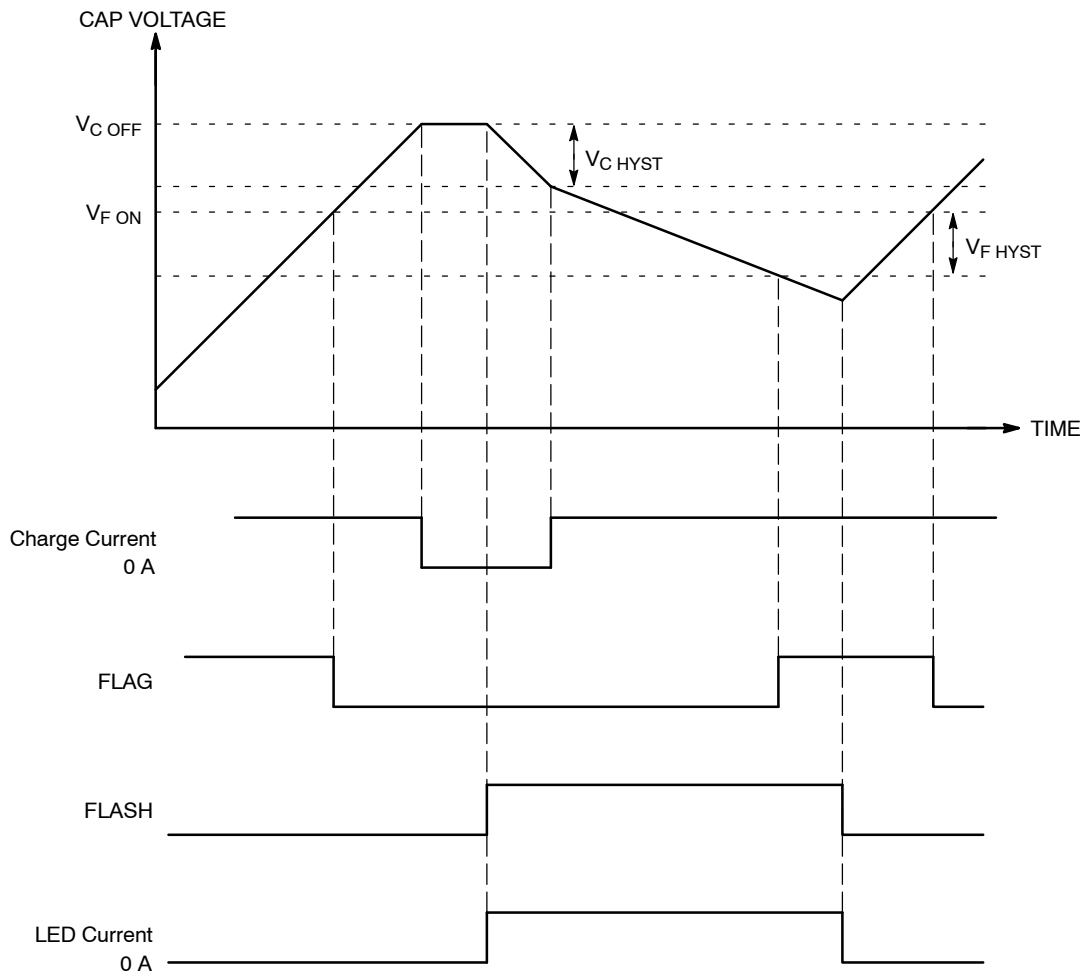

Figure 2. Supercapacitor Charge Timing Diagram

CAT3224

TYPICAL CHARACTERISTICS

(VIN = 3.6 V, C = 0.55 F, TAMB = 25°C, typical application circuit unless otherwise specified.)

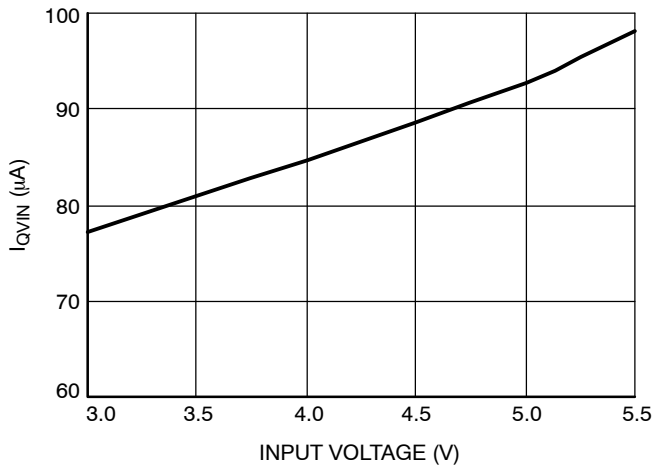

Figure 3. Idle Quiescent Current vs. Input Voltage

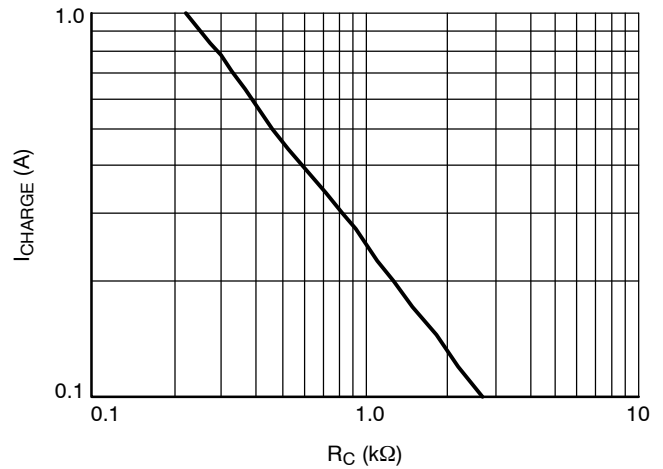

Figure 4. Charge Current vs. R_C

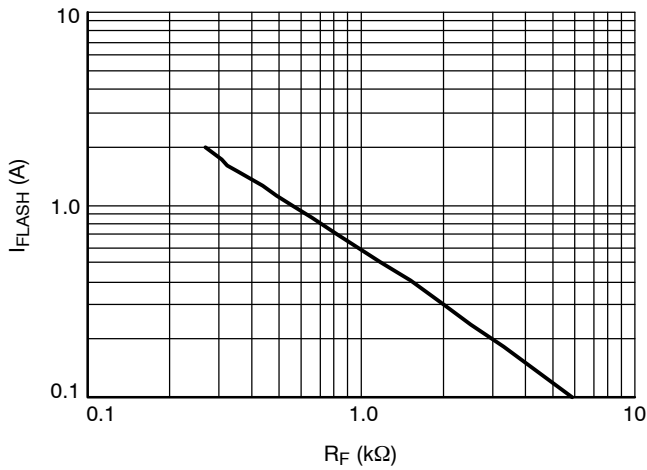

Figure 5. Flash LED Current vs. R_F

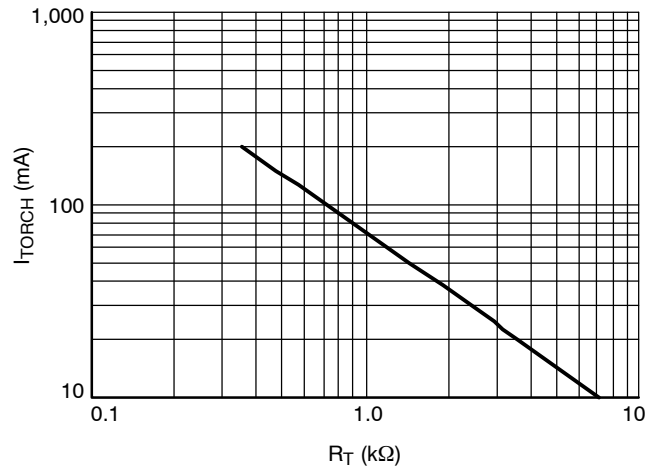

Figure 6. Torch LED Current vs. R_T

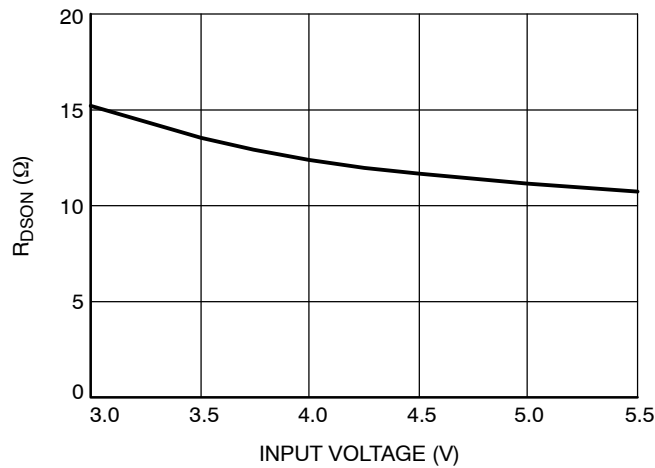

Figure 7. FLAG R_{DS(on)} vs. Input Voltage

CAT3224

TYPICAL CHARACTERISTICS

(VIN = 3.6 V, C = 0.55 F, T_{AMB} = 25°C, typical application circuit unless otherwise specified.)

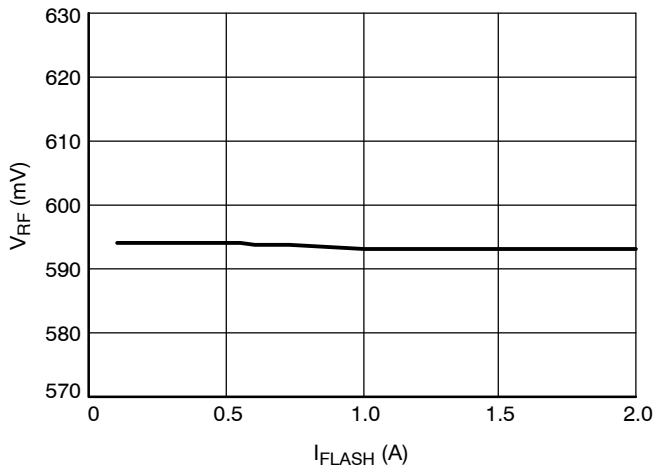

Figure 8. V_{RF} vs. I_{FLASH}

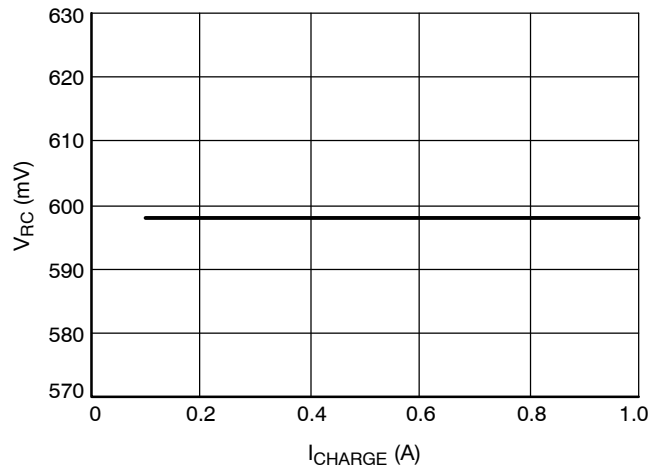

Figure 9. V_{RC} vs. I_{CHARGE}

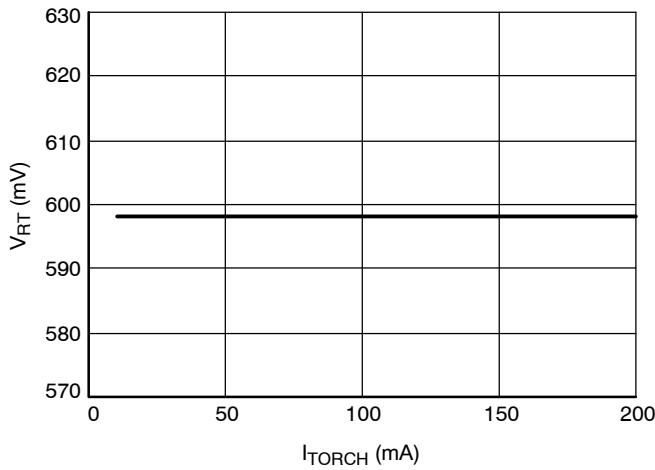

Figure 10. V_{RT} vs. I_{TORCH}

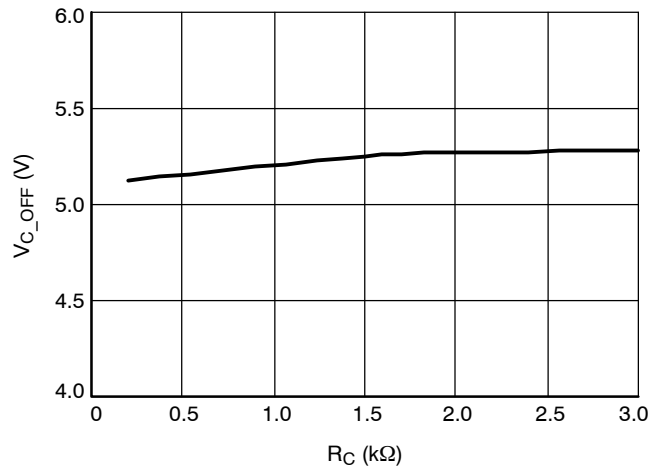

Figure 11. V_{CAP} idle vs. R_C

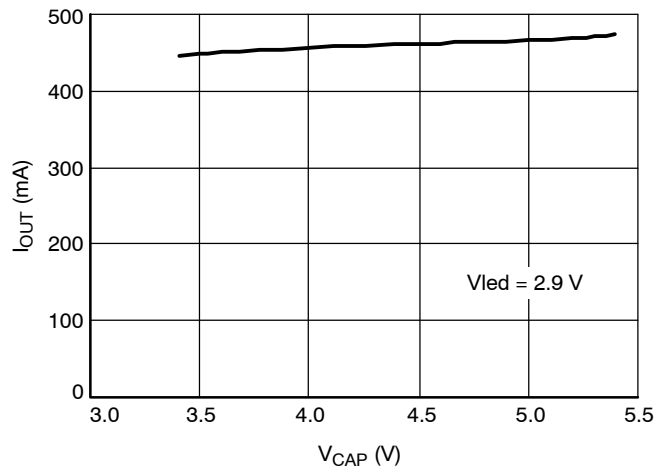

Figure 12. Torch Output Current vs. V_{CAP}

CAT3224

TYPICAL CHARACTERISTICS

(VIN = 3.6 V, C = 0.55 F, T_{AMB} = 25°C, typical application circuit unless otherwise specified.)

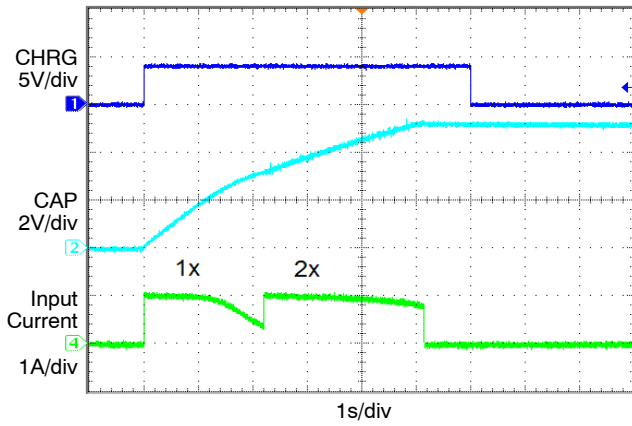

Figure 13. Charge Cycle, 1 A Input Current

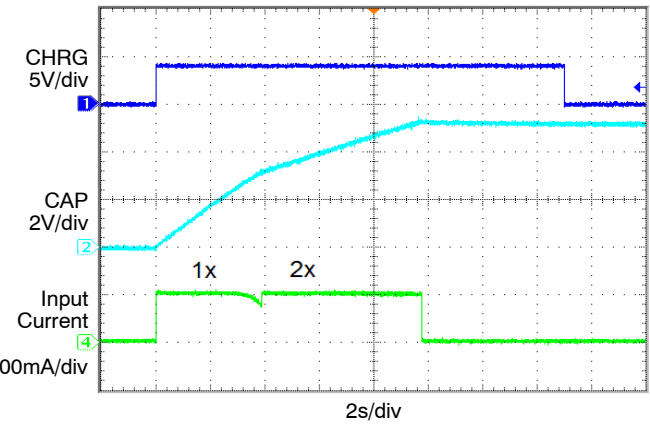

Figure 14. Charge Cycle, 500 mA Input Current

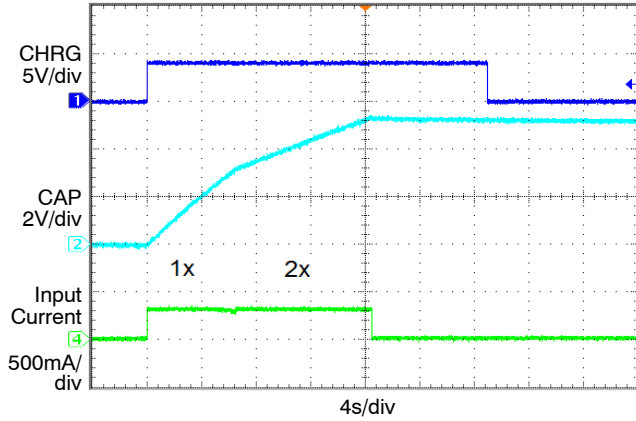

Figure 15. Charge Cycle, 300 mA Input Current

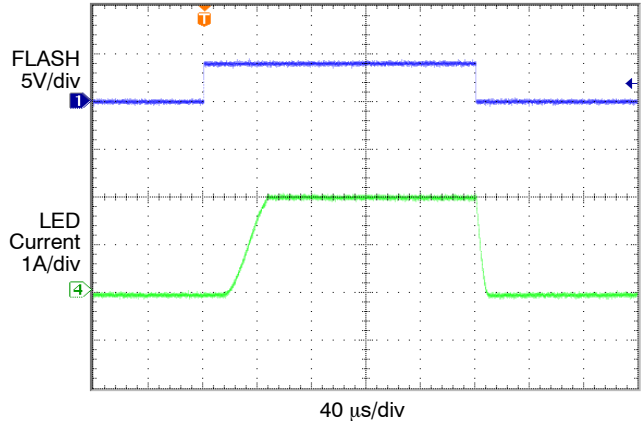

Figure 16. FLASH Transient Response

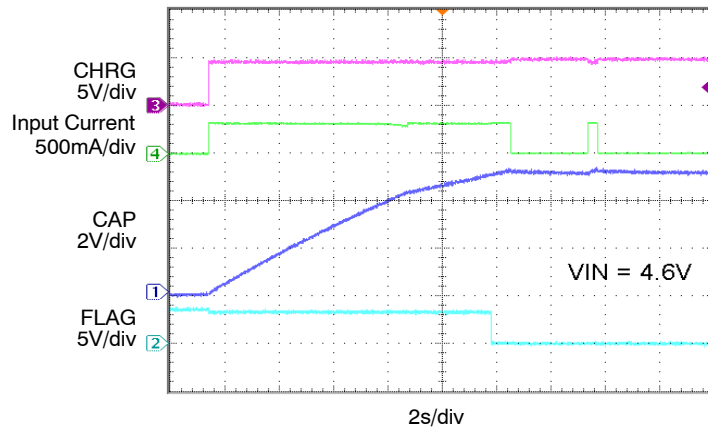

Figure 17. Charge Cycle with FLAG

Table 6. PIN DESCRIPTION

Pin #	Name	Function
1	RF	Flash Current Setting Resistor terminal
2	BAL	Active Supercapacitor Balance Control
3, 4	CAP	Supercapacitor Positive Connection
5	CHRG	Charge Supercapacitor Enable
6	FLASH	Flash Enable
7	TORCH	Torch Enable
8	FLAG	Flash Ready Flag output, Open drain (Active low)
9	LEDB	LED B channel anode (+) connection
10	LEDA	LED A channel anode (+) connection
11	RC	Charge Current Setting Resistor terminal
12	RT	Torch Current Setting Resistor terminal
13	VIN	Positive supply connection to battery
14	CP	Bucket capacitor Positive terminal
15	CN	Bucket capacitor Negative terminal
16	GND	Device ground connection
TAB	TAB	Connect to GND on the PCB

Pin Function

VIN is the supply pin for the device and for the supercapacitor charger circuit. A small 1 μ F ceramic bypass capacitor is required between the VIN pin and ground near the device.

GND is the ground reference for the charge pump. This pin must be connected to the ground plane on the PCB.

TAB is the exposed pad underneath the package. For best thermal performance, the tab should be soldered to the PCB and connected to the ground plane.

CAP is the positive connection to the supercapacitor. Current sinks or sources from this pin to the capacitor depending on the mode of operation.

CP, CN pins are connected to each side of the ceramic bucket capacitor used in the 2x charge pump mode.

LEDA, LEDB are connected internally to the current sources and must be connected to the LED anodes. Each output is independently current regulated. These pins enter a high-impedance ‘zero’ current state whenever the device is placed in shutdown mode or FLASH and TORCH are low.

BAL is connected to the center-point between the two supercapacitor cells. An active circuit forces the BAL pin to remain at half of the voltage of the CAP output.

RF is connected to a resistor (R_F) to set the current in the LED channels in flash mode. The voltage on the pin is regulated to 0.6 V in flash mode (FLASH high).

RT is connected to a resistor (R_T) to set the current in the LED channels in torch mode. The voltage on the pin is regulated to 0.6 V in torch mode (TORCH high).

RC is connected to a resistor (R_C) to set the current limit on VIN when charging the supercapacitor. The voltage on the pin is regulated to 0.6 V in charge mode (CHRG high).

CHRG is the charge mode enable pin. When high, the 1x/2x charge pump is enabled and allows to charge the supercapacitor and monitors its voltage.

FLASH is the flash mode enable pin. When high, the LED current sources are enabled in flash mode. If FLASH is kept high for longer than 300 ms typical, the LED channels are automatically disabled.

TORCH is the torch mode enable pin. When high, the LED current sources are enabled in torch mode.

FLAG is an active-low open-drain output that notify to the microcontroller that the supercapacitor is fully charged by pulling the output low. When using the flag, this pin should be connected to a positive rail via an external pull-up resistor.

CAT3224

Block Diagram

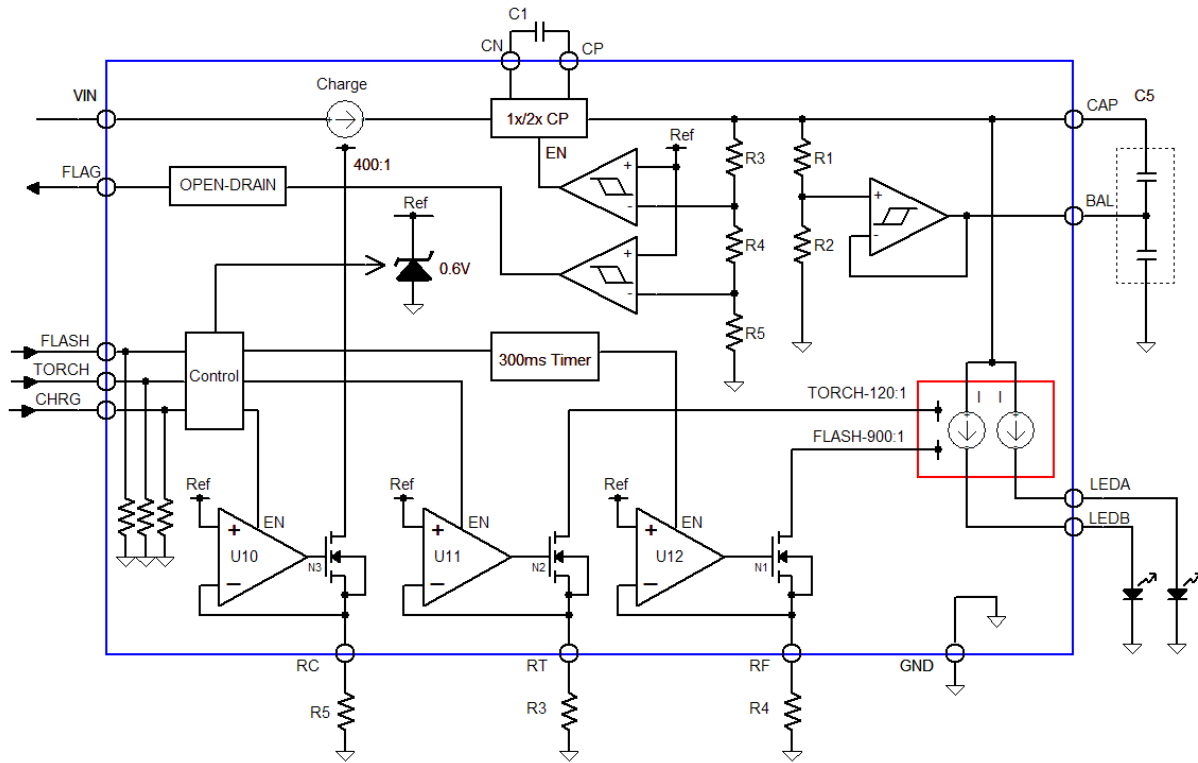

Figure 18. Functional Block Diagram

Basic Operation

The CAT3224 integrates in a single device two main functions: a dual cell supercapacitor charger and an LED driver. Two LED channels provide accurately regulated and matched current up to 2 A per channel. The charging mode is activated when the CHRГ control input is pulled high and can remain active even during torch or flash mode. This allows continuous torch mode operation. The two modes, torch and flash, are activated using separate control inputs respectively TORCH and FLASH.

Charge Mode

When the CHRГ input is set high, the driver is in charge mode and the input supply current cannot exceed the current limit set by an external resistor connected between the RC pin and ground. The charging current limit is calculated by the following equation (approximation).

$$I_{IN} \approx 400 \times I_{RC} = 400 \times \frac{V_{RC}}{R_C} = 400 \times \frac{0.6 V}{R_C}$$

If the CAP output voltage is lower than the charge threshold, the charging cycle starts. The driver charge pump initially starts in 1x mode and remains there as long as the supply voltage VIN is high enough to drive the CAP output voltage directly. In 1x mode, the output current charging the supercapacitor is approximately equal to the input current. The driver enters the 2x charge pump mode when the CAP pin voltage approaches VIN ($V_{CAP} \approx VIN - 0.3 V$). In 2x mode, the output current is approximately half of the input current. The charge cycle stops when either the CHRГ input is pulled low or when the CAP output reaches the “CAP charge off voltage” threshold. As soon as the CAP output reaches the “CAP voltage FLAG pulled low” threshold, the FLAG output is pulled low. There is an hysteresis on the FLAG output which is illustrated in the timing diagram on Figure 2.

The charge time is a function of the input voltage, input current setting, supercapacitor value, final CAP voltage.

The RC pin has a current limit of 3.5 mA typical. If the RC pin is shorted to ground, the maximum charge current is 400 x 3.5 mA or 1.4 A.

Torch Mode

The torch mode allows the LEDs to run for extended time duration but at a lower current than in the flash mode. When the TORCH input is set high, the driver is in torch mode and the LED channel current is set according to the external resistor connected between the RT pin and ground. The torch mode LED current per channel follows the equation:

$$I_{TORCH} \approx 120 \times I_{RT} = 120 \times \frac{V_{RT}}{R_T} = 120 \times \frac{0.6 V}{R_T}$$

How long the LED current is regulated depends on the initial CAP voltage, capacitor value, the charge current, LED forward voltage and the LED torch current setting. In order to maintain regulation in 2x mode, the torch output

current should be less than half the charging current. If the requested torch current is greater than half the input current, the LEDs will dim progressively according to the input current.

Flash Mode

When the FLASH input is set high, the driver is in flash mode and the LED channel current is set according to the external resistor connected between the RF pin and ground. The flash mode LED channel current can be calculated by the following equation (approximation).

$$I_{FLASH} \approx 900 \times I_{RF} = 900 \times \frac{V_{RF}}{R_F} = 900 \times \frac{0.6 V}{R_F}$$

Table 7 shows some standard resistor values for RF and the corresponding LED channel current.

Table 7. RSET Resistor Settings

LED Current per Channel [A]	RF [Ω]
1	549
1.5	360
2	261

The maximum flash duration where the LED current is regulated depends on the initial CAP voltage, capacitor value, LED forward voltage and the LED flash current setting. The flash pulse duration can be calculated as follows.

$$T_{FLASH} = C \times \frac{\Delta V_{CAP}}{I_{FLASH}}$$

where C is the total supercapacitor value, ΔV_{CAP} is the drop in the CAP voltage during the flash. See the Capacitor Selection section for more details.

The RF pin has a current limit of 3.5 mA typical. If the RF pin is shorted to ground, the maximum flash LED current is 1000 x 3.5 mA or 3.5 A.

During flash mode, the LEDs stay in regulation as long as their forward voltage does not exceed a maximum voltage calculated as follows:

$$V_{Fmax} = V_{CAP} - I_{OUT} \times (R_{CAP-ESR} + R_{LEDAB})$$

where IOUT is the CAP total output current, RCAP-ESR is the supercapacitor ESR (equivalent series resistance), and RLEDAB is the LEDA/B combined dropout resistance of the CAT3224.

The transient waveform in Figure 19 shows the CAP output voltage during a 4 A flash pulse (2 A per LED channel) with CHRГ low (not in charge mode). The initial drop on the CAP voltage (V_{esr}) is due to the supercapacitor ESR. In this example, it is calculated as follows.

$$V_{esr} = 2 \times I_{LED} \times R_{CAP-ESR} = 2 \times 2A \times 0.1 \Omega = 0.4 V$$

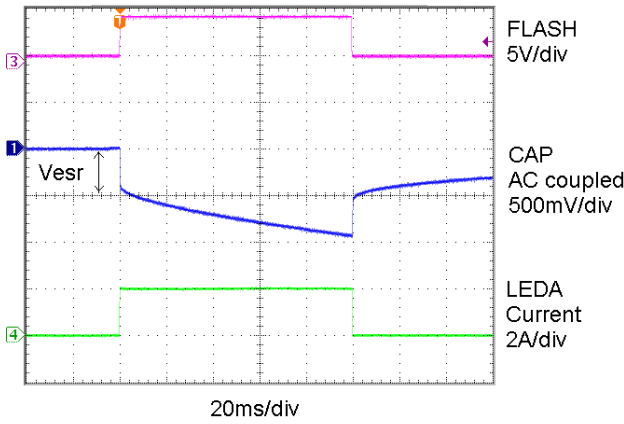

Figure 19. CAP Output Transient during 4 A Flash

Flash Rate

Between two consecutive flash pulses, the supercapacitor needs some time to recharge. The supercapacitor time needed to fully recharge after a flash pulse is a function of the flash current and duration, and the charging current. Assuming the driver is in 2x mode, the charging time is calculated as follows.

$$T_{\text{CHARGE}} = 2 \times \frac{I_{\text{OUT}}}{I_{\text{IN}}} \times T_{\text{FLASH}}$$

where I_{OUT} is the total LED current, T_{FLASH} is the flash duration and I_{IN} is the input current.

For example, a 60 ms 4 A flash pulse with a charge current of 300 mA corresponds to a recharge time:

$$T_{\text{CHARGE}} = 2 \times \frac{4 \text{ A}}{0.3 \text{ A}} \times 0.06 \text{ s} = 1.6 \text{ s}$$

Capacitor Selection

The supercapacitor size depends on the flash requirement including flash duration, LED current and LED forward voltage. The minimum supercapacitor value is calculated as follows.

$$C = \frac{I_{\text{OUT}} \times T_{\text{FLASH}}}{V_{\text{CAP}} - I_{\text{OUT}}(R_{\text{CAP-ESR}} + R_{\text{LEDAB}}) - V_{\text{F}}}$$

where V_{CAP} is the initial CAP voltage (5.2 V typical), and V_{F} is the LED forward voltage. Any interconnection parasitic resistance is assumed negligible in the calculation.

For example, for a 4 A flash with 0.1 s duration and 3.1 V LED V_{F} , the minimum capacitor value is:

$$C = \frac{4 \text{ A} \times 0.1 \text{ s}}{5.2 \text{ V} - 4 \text{ A}(0.1 \Omega + 0.1 \Omega) - 3.1 \text{ V}} \cong 0.3 \text{ F}$$

To support 4 A flash pulses, we recommend using the 0.55 F supercapacitor HS206F from CAP-XX with a voltage rating of 5.5 V and a low ESR of 85 mΩ.

In addition to the supercapacitor, a small 1 μF ceramic capacitor is recommended on the CAP output in order to filter out the charge pump switching noise due to the ESR of the supercapacitor.

If a single cell supercapacitor is used, it is recommended to connect a small 1 μF ceramic capacitor between the BAL pin and GND. This will prevent any oscillation on the BAL pin and keep the quiescent current low.

Thermal Dissipation

Thermal dissipation occurs in the CAT3224 device due to the high current flowing in charge mode, as well as in torch or flash mode. During charge mode, in case the input voltage is high and the driver operates in 2x charge pump mode, the power dissipation may increase significantly. In torch and flash modes, the power dissipation is proportional to the difference between the CAP and LEDA/B pin voltages. If the junction temperature exceeds 150°C typical, the device goes into thermal shutdown mode and resumes normal operation as soon as the temperature drops by about 20°C. To improve the thermal performance, the TQFN exposed pad should be connected to the PCB ground plane underneath.

Recommended Layout

The ground side of the three current setting resistors, R_{C} , R_{T} , R_{F} should be star connected back to the GND of the PCB. In charge pump mode, the driver switches internally at a high frequency. Therefore it is recommended to minimize trace length to all four capacitors. A ground plane should cover the area under the driver IC as well as the bypass capacitors. Short connection to ground on capacitors C_{IN} and C_{OUT} can be implemented with the use of multiple via. A copper area matching the TQFN exposed pad (TAB) must be connected to the ground plane underneath with a via.

In order to minimize the IR drop in flash mode, the traces between the supercapacitor and the CAP pins, and between LEDA/LEDB pins and the LED(s) should be kept as short as possible and wide enough to handle the high current peaks. The supercapacitor negative terminal and the LED cathodes need to be connected to the ground plane directly.

CAT3224

Example of Ordering Information (Note 4)

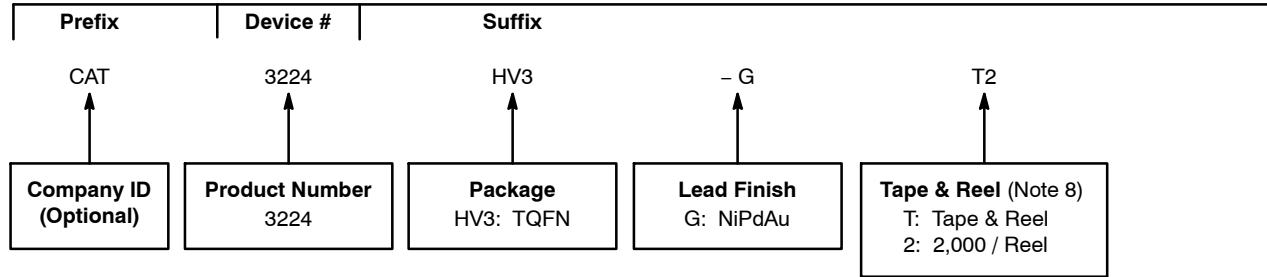

4. The device used in the above example is a CAT3224HV3-GT2 (TQFN, NiPdAu, Tape & Reel, 2,000 / Reel).
5. All packages are RoHS-compliant (Lead-free, Halogen-free).
6. The standard lead finish is NiPdAu.
7. For additional package and temperature options, please contact your nearest ON Semiconductor sales office.
8. For information on tape and reel specifications, including part orientation and tape sizes, please refer to our Tape and Reel Packaging Specifications Brochure, BRD8011/D.

TQFN16, 3x3
CASE 510AD
ISSUE A

DATE 19 MAR 2008

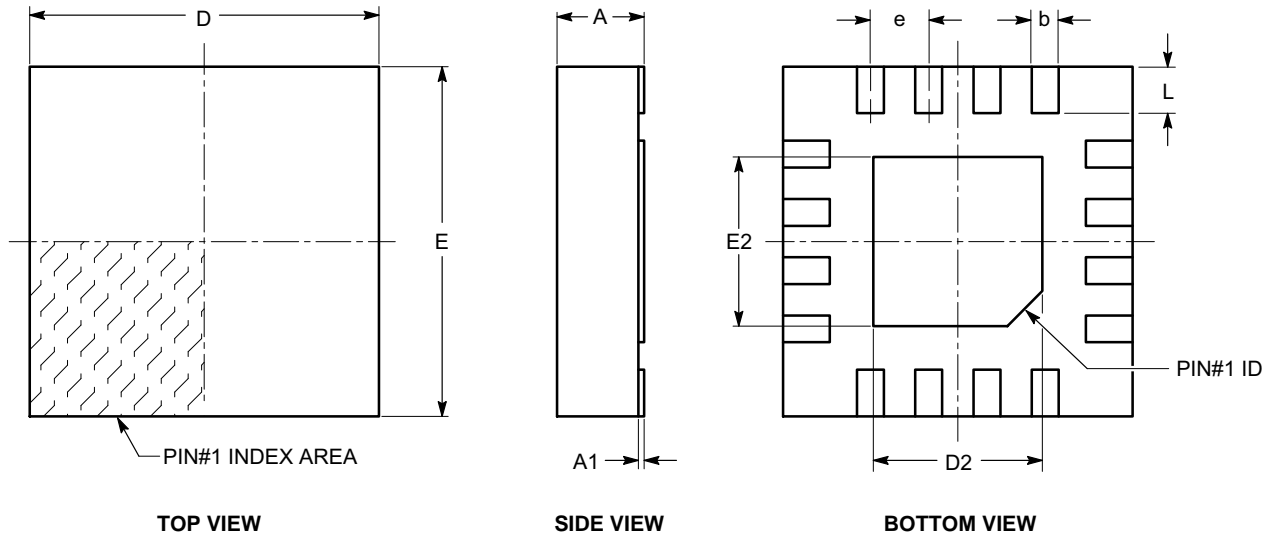

SYMBOL	MIN	NOM	MAX
A	0.70	0.75	0.80
A1	0.00	0.02	0.05
A3	0.20 REF		
b	0.18	0.25	0.30
D	2.90	3.00	3.10
D2	1.40	---	1.80
E	2.90	3.00	3.10
E2	1.40	---	1.80
e	0.50 BSC		
L	0.30	0.40	0.50

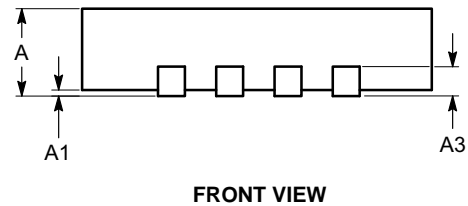

Notes:

- (1) All dimensions are in millimeters.
- (2) Complies with JEDEC MO-220.

DOCUMENT NUMBER:	98AON34373E	Electronic versions are uncontrolled except when accessed directly from the Document Repository. Printed versions are uncontrolled except when stamped "CONTROLLED COPY" in red.
DESCRIPTION:	TQFN16, 3X3	PAGE 1 OF 1

onsemi and ONSEMI are trademarks of Semiconductor Components Industries, LLC dba onsemi or its subsidiaries in the United States and/or other countries. onsemi reserves the right to make changes without further notice to any products herein. onsemi makes no warranty, representation or guarantee regarding the suitability of its products for any particular purpose, nor does onsemi assume any liability arising out of the application or use of any product or circuit, and specifically disclaims any and all liability, including without limitation special, consequential or incidental damages. onsemi does not convey any license under its patent rights nor the rights of others.

onsemi, **Onsemi**, and other names, marks, and brands are registered and/or common law trademarks of Semiconductor Components Industries, LLC dba "**onsemi**" or its affiliates and/or subsidiaries in the United States and/or other countries. **onsemi** owns the rights to a number of patents, trademarks, copyrights, trade secrets, and other intellectual property. A listing of **onsemi**'s product/patent coverage may be accessed at www.onsemi.com/site/pdf/Patent-Marking.pdf. **onsemi** reserves the right to make changes at any time to any products or information herein, without notice. The information herein is provided "as-is" and **onsemi** makes no warranty, representation or guarantee regarding the accuracy of the information, product features, availability, functionality, or suitability of its products for any particular purpose, nor does **onsemi** assume any liability arising out of the application or use of any product or circuit, and specifically disclaims any and all liability, including without limitation special, consequential or incidental damages. Buyer is responsible for its products and applications using **onsemi** products, including compliance with all laws, regulations and safety requirements or standards, regardless of any support or applications information provided by **onsemi**. "Typical" parameters which may be provided in **onsemi** data sheets and/or specifications can and do vary in different applications and actual performance may vary over time. All operating parameters, including "Typicals" must be validated for each customer application by customer's technical experts. **onsemi** does not convey any license under any of its intellectual property rights nor the rights of others. **onsemi** products are not designed, intended, or authorized for use as a critical component in life support systems or any FDA Class 3 medical devices or medical devices with a same or similar classification in a foreign jurisdiction or any devices intended for implantation in the human body. Should Buyer purchase or use **onsemi** products for any such unintended or unauthorized application, Buyer shall indemnify and hold **onsemi** and its officers, employees, subsidiaries, affiliates, and distributors harmless against all claims, costs, damages, and expenses, and reasonable attorney fees arising out of, directly or indirectly, any claim of personal injury or death associated with such unintended or unauthorized use, even if such claim alleges that **onsemi** was negligent regarding the design or manufacture of the part. **onsemi** is an Equal Opportunity/Affirmative Action Employer. This literature is subject to all applicable copyright laws and is not for resale in any manner.

ADDITIONAL INFORMATION

TECHNICAL PUBLICATIONS:

Technical Library: www.onsemi.com/design/resources/technical-documentation
onsemi Website: www.onsemi.com

ONLINE SUPPORT: www.onsemi.com/support

For additional information, please contact your local Sales Representative at www.onsemi.com/support/sales