

# Constant Current LED Driver with 32 Dimming Levels and Rset

## CAT4002A, CAT4004A

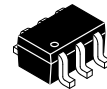

UDFN-8  
HU2G SUFFIX  
CASE 517AW



SC70-6  
SD SUFFIX  
CASE 419AD

### Description

The CAT4002A and CAT4004A provide respectively two and four matched low dropout current sources to drive LEDs. The CAT400XA uses an external resistor RSET to set the current in the LED channels. Each LED channel includes an individual control loop allowing the device to handle a wide range of LED forward voltages while still maintaining tight current matching.

The EN/DIM logic inputs supports device enable and a digital dimming interface for setting the LED channel current with 32 linear dimming levels.

LEDs can be powered directly from a Lithium-ion battery due to the low dropout (50 mV at 20 mA) current sinks. The device is available in the tiny 8-pad UDFN 2 mm x 2 mm package with a max height of 0.55 mm, as well as the 6-lead SC-70.

### Features

- 2 and 4 LED Current Sinks with Tight Matching
- 32 Dimming Levels
- Low Dropout Driver 50 mV at 20 mA
- No Switching Noise
- Shutdown Current less than 1  $\mu$ A
- LED Current set by External Resistor
- Dimming via 1-wire EZDim Interface
- Thermal Shutdown Protection
- 6-lead SC-70, and 8-pad UDFN 2 mm x 2 mm Packages
- These Devices are Pb-Free, Halogen Free/BFR Free and are RoHS Compliant

### Applications

- LCD Display Backlight
- Digital Still Cameras
- Cellular Phones
- Handheld Devices

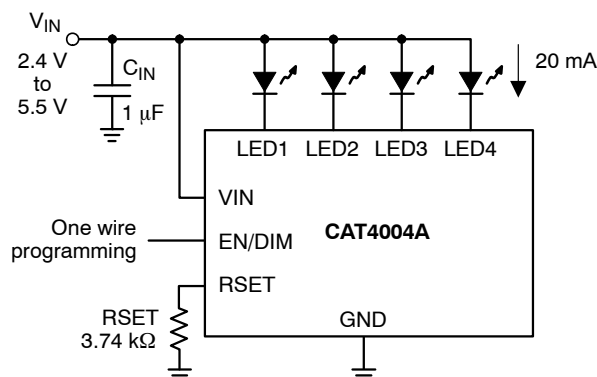
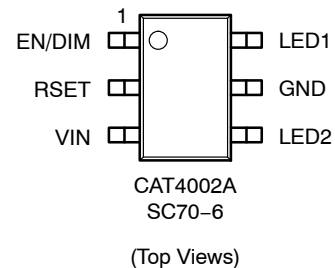
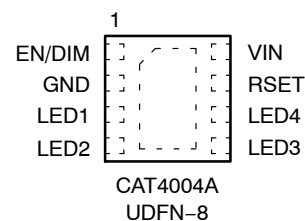

Figure 1. Typical Application Circuit

### PIN CONNECTIONS



### ORDERING INFORMATION

See detailed ordering and shipping information in the package dimensions section on page 8 of this data sheet.

# CAT4002A, CAT4004A

## MARKING DIAGRAMS

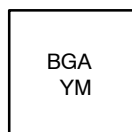

UDFN8 (2 x 2 mm)

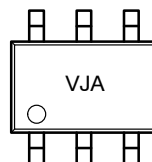

SC70-6

BG = CAT4004A Device Code  
 A = Assembly Location Code  
 Y = Production Year (last digit)  
 M = Production Month: 1 – 9, A, B, C

VJ = CAT4002A Device Code  
 A = Assembly Location Code

**Table 1. ABSOLUTE MAXIMUM RATINGS**

Parameter	Rating	Unit
VIN, LEDx, RSET	6	V
EN/DIM Voltage	6	V
Storage Temperature Range	-65 to +160	°C
Junction Temperature Range	-40 to +125	°C
Lead Temperature	300	°C

Stresses exceeding those listed in the Maximum Ratings table may damage the device. If any of these limits are exceeded, device functionality should not be assumed, damage may occur and reliability may be affected.

**Table 2. ELECTRICAL OPERATING CHARACTERISTICS** (Min and Max values are over recommended operating conditions unless specified otherwise. Typical values are at VIN = 4.0 V, EN/DIM = High, and TAMB = 25°C.)

Symbol	Name	Conditions	Min	Typ	Max	Units
I <sub>Q</sub>	Quiescent Current	No load, RSET = Float No load, RSET = 4.8 kΩ		0.2 0.5		mA
I <sub>QSHDN</sub>	Shutdown Current	V <sub>EN/DIM</sub> = 0 V			1	μA
I <sub>LED</sub>	LED Current Setting	RSET = 3.0 kΩ		25		mA
		RSET = 4.99 kΩ		15		
I <sub>LED-ACC</sub>	LED Current Accuracy	1 mA ≤ I <sub>LED</sub> ≤ 40 mA		±1		%
I <sub>LED-DEV</sub>	LED Channel Matching (Note 1)	$\frac{I_{LED} - I_{LEDAVG}}{I_{LEDAVG}}$	-5	±1	+5	%
V <sub>RSET</sub>	RSET pin regulated voltage		0.57	0.6	0.63	V
V <sub>DOUT</sub>	Dropout Voltage (90% of nominal LED current)	I <sub>LED</sub> = 20 mA		50		mV
		I <sub>LED</sub> = 1 mA		25		
R <sub>EN/DIM</sub> V <sub>HI</sub> V <sub>LO</sub>	EN/DIM Pin					
	- Internal pull-down resistor		1.3	200		kΩ
	- Logic High Level				0.4	V
	- Logic Low Level					V
T <sub>SD</sub>	Thermal Shutdown			150		°C
T <sub>HYS</sub>	Thermal Hysteresis			20		°C
V <sub>UVLO</sub>	Undervoltage lockout (UVLO) threshold			2.0		V

1. For CAT4004A, I<sub>LEDAVG</sub> = (I<sub>LED,CH1</sub> + I<sub>LED,CH2</sub> + I<sub>LED,CH3</sub> + I<sub>LED,CH4</sub>) / 4  
 For CAT4002A, I<sub>LEDAVG</sub> = (I<sub>LED,CH1</sub> + I<sub>LED,CH2</sub>) / 2

# CAT4002A, CAT4004A

**Table 3. RECOMMENDED OPERATING CONDITIONS**

Parameter	Rating	Unit
V <sub>IN</sub>	2.4 to 5.5	V
Ambient Temperature Range	-40 to +85	°C
I <sub>LED</sub> per LED pin	0 to 40	mA

NOTE: Typical application circuit with external components is shown on page 1.

**Table 4. RECOMMENDED EN/DIM TIMING** (For 2.4 V ≤ V<sub>IN</sub> ≤ 5.5 V, over full ambient temperature range -40°C to +85°C.)

Symbol	Name	Conditions	Min	Typ	Max	Units
T <sub>LO</sub>	EN/DIM program low time		0.2		100	μs
T <sub>HI</sub>	EN/DIM program high time		0.2			μs
T <sub>LED</sub>	LED current settling time			10		μs
T <sub>PWRDWN</sub>	EN/DIM low time to shutdown			3	5	ms

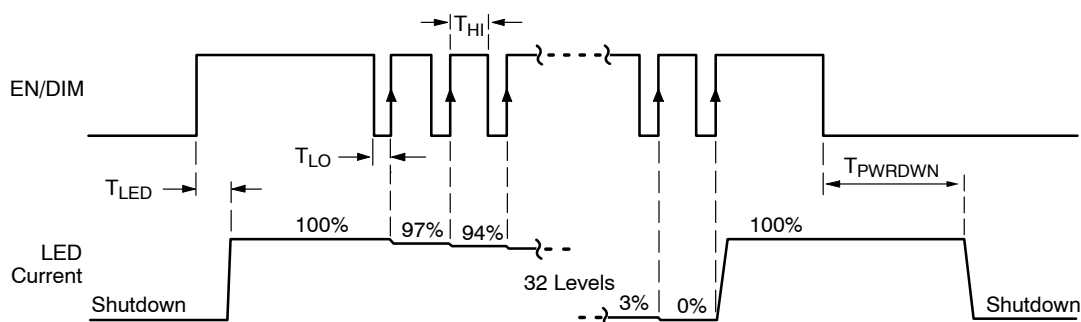

**Figure 2. CAT400XA EN/DIM Dimming Timing Diagram**

## LED Current Setting

On the CAT400XA, the full scale LED current is set by the external resistor connected between the RSET pin and ground. Table 5 lists standard resistor values for several LED current settings.

When the EN/DIM is initially taken high, the CAT400XA becomes enabled and the LED channel current is set to the full scale current according to the resistor RSET.

$$I_{LED} \cong 125 \times V_{RSET} / RSET$$

**Table 5. RSET RESISTOR AND LED CURRENT**

Full Scale LED Current [mA]	RSET [kΩ]
2	40.2
5	15.4
10	7.68
15	4.99
20	3.74
25	3.00
30	2.49
40	1.87

# CAT4002A, CAT4004A

## TYPICAL PERFORMANCE CHARACTERISTICS

(CAT4002A,  $V_{IN} = 4\text{ V}$ ,  $V_F = 3.3\text{ V}$ ,  $I_{OUT} = 50\text{ mA}$  (2 LEDs at 25 mA),  $C_{IN} = 1\text{ }\mu\text{F}$ ,  $T_{AMB} = 25^\circ\text{C}$  unless otherwise specified.)

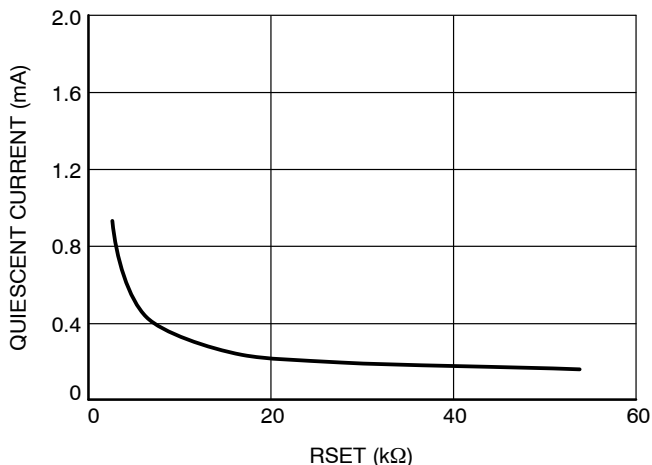

**Figure 3. Quiescent Current vs. RSET Input Voltage**

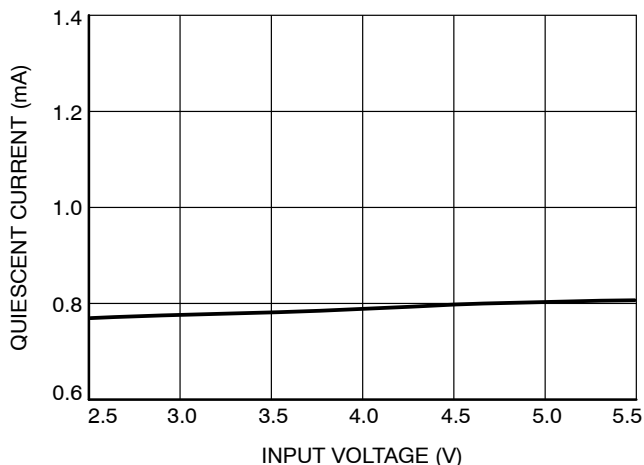

**Figure 4. Quiescent Current vs. Input Voltage (Full Load)**

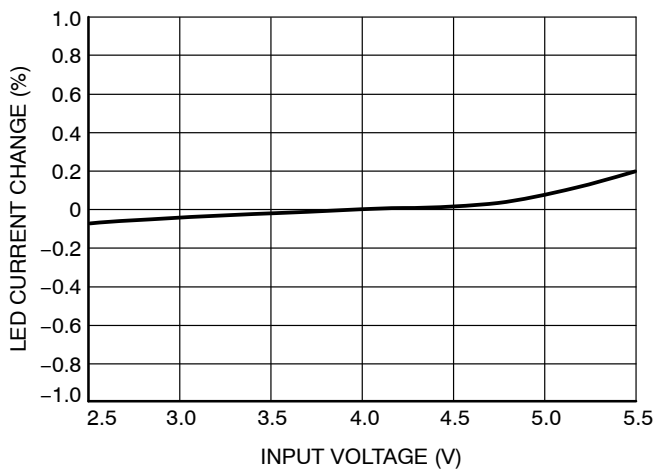

**Figure 5. LED Current Change vs. Input Voltage**

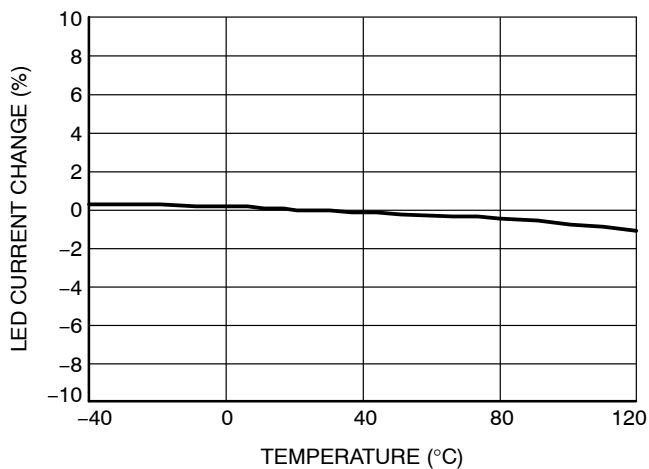

**Figure 6. LED Current Change vs. Temperature**

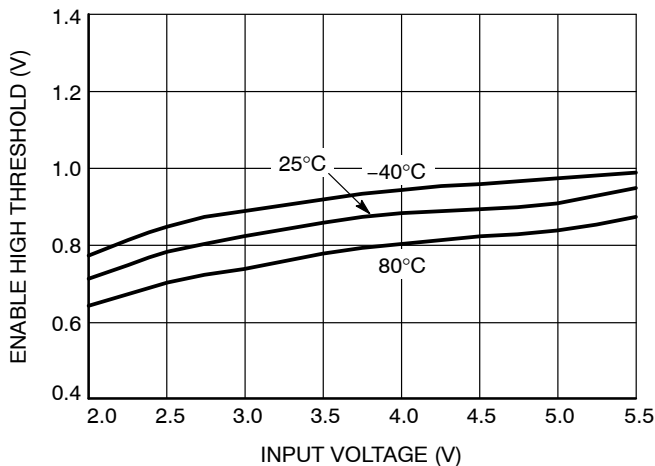

**Figure 7. EN/DIM High Threshold vs. Input Voltage**

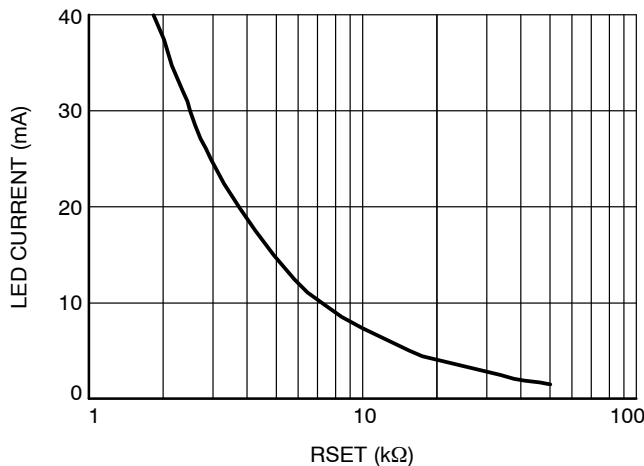

**Figure 8. LED Current vs. RSET Resistor**

# CAT4002A, CAT4004A

## TYPICAL PERFORMANCE CHARACTERISTICS

(CAT4002A,  $V_{IN} = 4\text{ V}$ ,  $V_F = 3.3\text{ V}$ ,  $I_{OUT} = 50\text{ mA}$  (2 LEDs at 25 mA),  $C_{IN} = 1\text{ }\mu\text{F}$ ,  $T_{AMB} = 25^\circ\text{C}$  unless otherwise specified.)

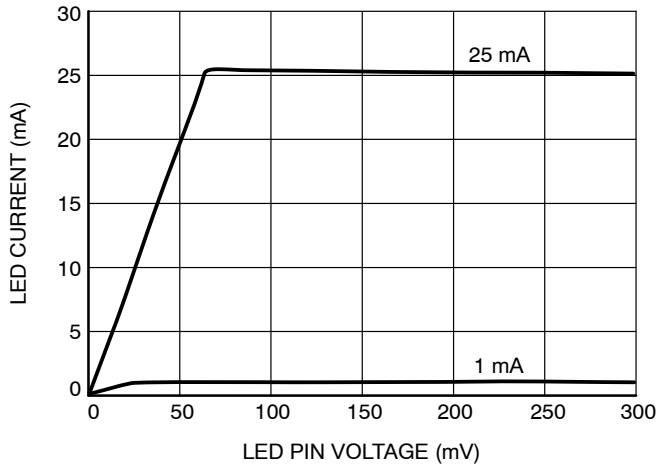

Figure 9. Dropout Characteristics

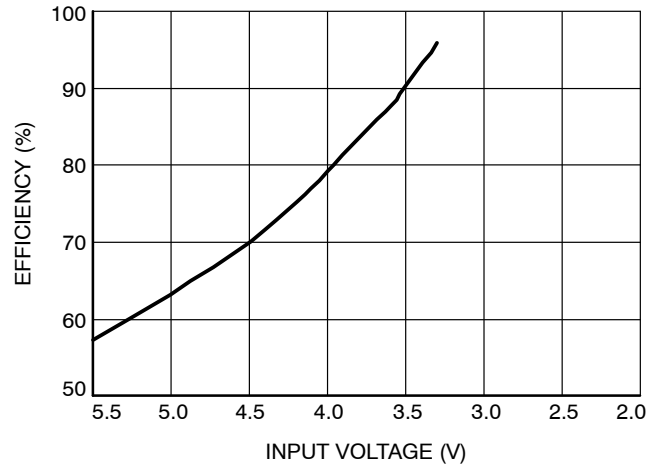

Figure 10. Efficiency vs. Input Voltage

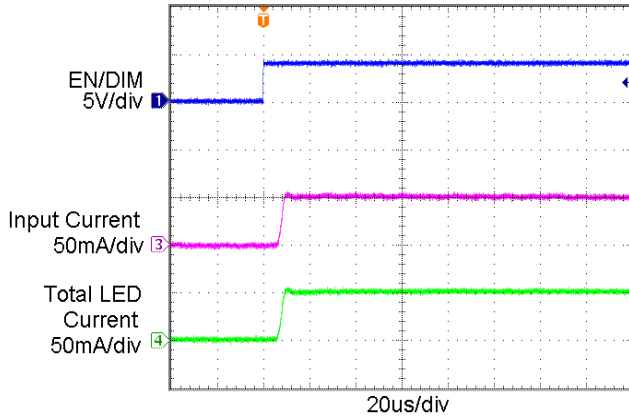

Figure 11. Power Up Waveform

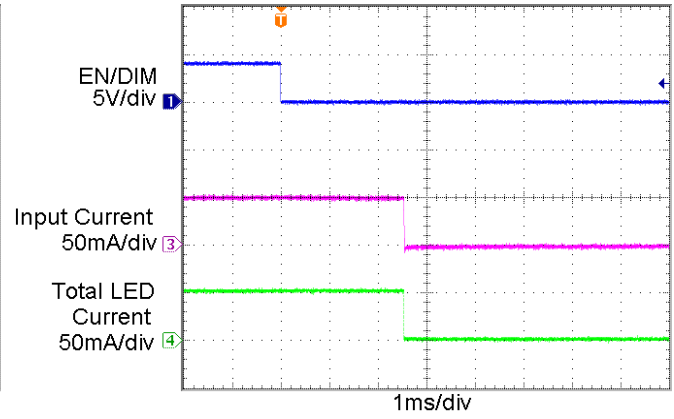

Figure 12. Power Down Waveform

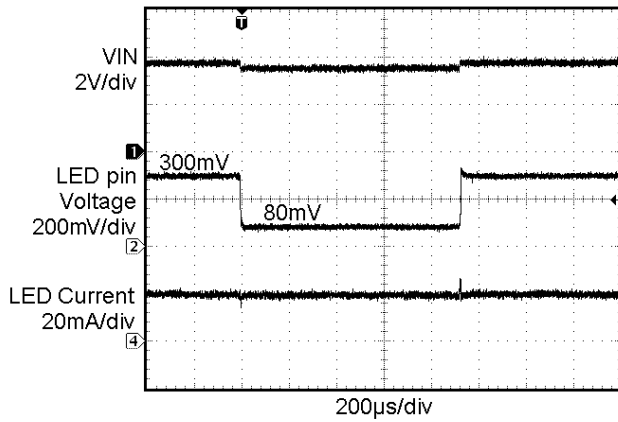

Figure 13. Line Transient Waveform

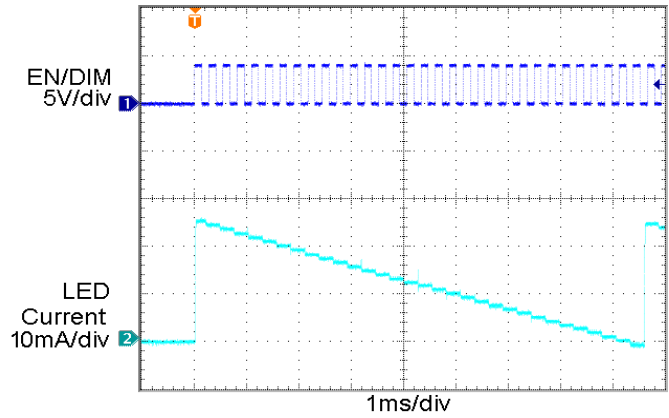

Figure 14. Dimming Levels

# CAT4002A, CAT4004A

**Table 6. PIN DESCRIPTIONS**

Name	Function
EN/DIM	Device enable (active high) and dimming control
GND	Ground reference
LED1	LED1 cathode terminal
LED2	LED2 cathode terminal
LED3	LED3 cathode terminal (CAT4004A only)
LED4	LED4 cathode terminal (CAT4004A only)
RSET	Connect external RSET resistor to set the LED current
VIN	Device supply input, connect to battery or supply
TAB	Connect to GND on the PCB (CAT4004A only)

### Pin Function

**VIN** is the supply pin for the charge pump. A small 1  $\mu$ F ceramic bypass capacitor is required between the VIN pin and ground near the device. The operating input voltage range is from 2.5 V to 5.5 V. Whenever the input supply falls below the under-voltage threshold (2.0 V), all the LED channels are disabled and the device enters shutdown mode.

**EN/DIM** is the enable and one wire dimming input for all LED channels. Levels of logic high and logic low are set at 1.3 V and 0.4 V respectively. When EN/DIM is initially taken high, the CAT400XA becomes enabled and the LED channel current is set to the full scale according to the resistor  $R_{SET}$ . To place the device into “zero current” shutdown mode, the EN/DIM pin must be held low for 3 ms typical.

**LED1 to LED4** provide the internal regulated current for each of the LED cathodes. These pins enter a high impedance zero current state whenever the device is placed in shutdown mode.

**RSET** is connected to the resistor ( $R_{SET}$ ) to set the full scale current for the LEDs. The voltage at this pin is regulated to 0.6 V. The ground side of the external resistor should be star connected back to the GND of the PCB. In shutdown mode, the RSET input becomes high impedance.

**GND** is the ground reference for the device. The pin must be connected to the ground plane on the PCB.

**TAB** (CAT4004A only) is the exposed pad underneath the package. For best thermal performance, the tab should be soldered to the PCB and connected to the ground plane.

### Block Diagram

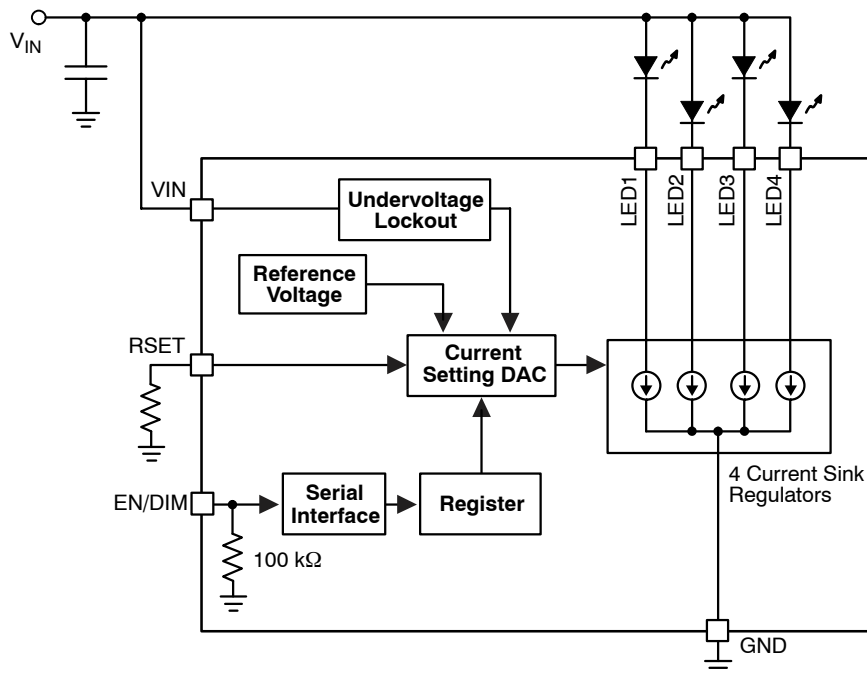

**Figure 15. CAT4004A Functional Block Diagram**

# CAT4002A, CAT4004A

## Basic Operation

The CAT400XA uses tightly matched current sinks to accurately regulate LED current in each channel proportional to the current sourced from the RSET pin.

There are 32 different settings for LED brightness that can be programmed through the EN/DIM pin. Tight current regulation for all channels is possible over a wide range of input and LED voltages due to independent current sensing circuitry on each channel.

Each LED channel needs a minimum of 50 mV headroom to sink a constant regulated current of 20 mA. If the input supply falls below 2.0 V typical, the under-voltage lockout circuit disables all LED channels and resets the circuit to default values. Any unused LED channels should be left open.

## LED Current Selection

After power-up, the LED current is set by the external resistor ( $R_{SET}$ ) value and the number of pulses (n) on the EN/DIM input as follows:

$$\text{LED current} = 125 \times \frac{0.6 \text{ V}}{R_{SET}} \times \left( \frac{31 - n}{31} \right)$$

The full scale current is calculated from the above formula with n equal to zero.

The EN/DIM pin has two primary functions. One function enables and disables the device. The other function is LED current dimming with 32 different levels by pulsing the input signal, as shown on Figure 16. On each consecutive pulse rising edge, the LED current is decreased by about 3.2% (1/31<sup>th</sup> of the full scale value). After 30 pulses, the LED current is 3.2% of the full scale current. On the 31<sup>st</sup> pulse, the current drops to zero, and then goes back to full scale on the following pulse.

Each pulse width should be between 200 ns and 100  $\mu$ s. Pulses faster than the minimum  $T_{LO}$  may be ignored and filtered by the device. Pulses longer than the maximum  $T_{LO}$  may shutdown the device. By pulsing the EN/DIM signal at high frequency, the LED current can quickly be set to zero.

The LED driver enters a “zero current” shutdown mode if EN/DIM is held low for 3 ms typical.

The dimming level is set by the number of pulses on the EN/DIM after the power-up, as shown in Table 7.

Table 7. DIMMING LEVELS

Full Scale (Current in %)	Dimming Pulses [n]
100	0
97	1
94	2
90	3
87	4
84	5
81	6
77	7
74	8
71	9
68	10
65	11
61	12
58	13
55	14
52	15
48	16
45	17
42	18
39	19
35	20
32	21
29	22
26	23
23	24
19	25
16	26
13	27
10	28
6	29
3	30
0	31
100	32

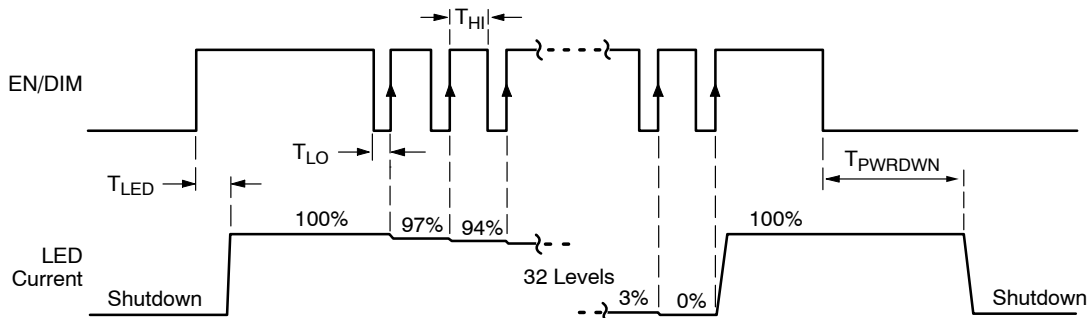
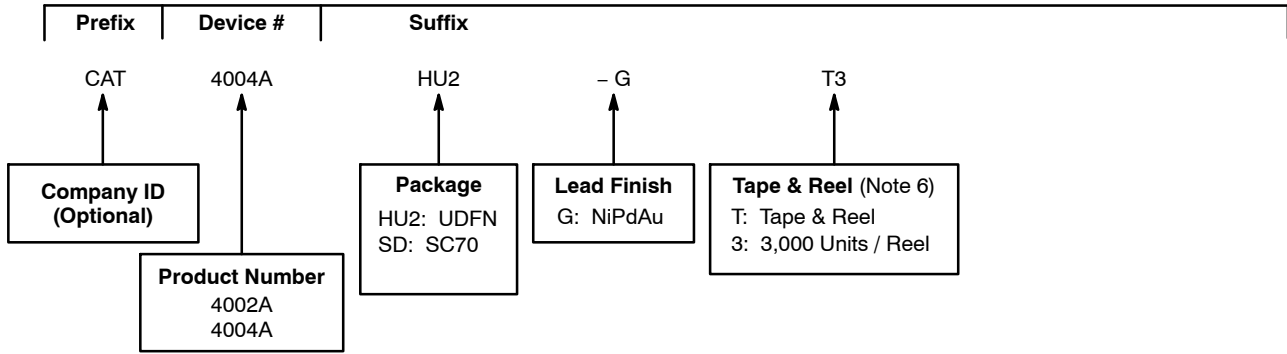

Figure 16. EN/DIM Digital Dimming Timing Diagram

# CAT4002A, CAT4004A

## Example of Ordering Information (Note 4)



**Table 8. ORDERING INFORMATION**

Part Number	Package	Quantity per Reel
CAT4002ASD-GT3	SC70-6	3,000
CAT4004AHU2-GT3	UDFN-8 (2 x 2 mm)	3,000

2. All packages are RoHS-compliant (Lead-free, Halogen-free).
3. The standard lead finish is NiPdAu.
4. The device used in the above example is a CAT4004AHU2-GT3 (UDFN, NiPdAu, Tape & Reel, 3,000/Reel).
5. For additional package and temperature options, please contact your nearest **onsemi** Sales office.
6. For information on tape and reel specifications, including part orientation and tape sizes, please refer to our Tape and Reel Packaging Specifications Brochure, BRD8011/D.



**MECHANICAL CASE OUTLINE**  
**PACKAGE DIMENSIONS**

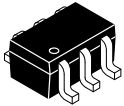

1

**SC-88 (SC-70 6 Lead), 1.25x2**  
**CASE 419AD**  
**ISSUE A**

DATE 07 JUL 2010



**TOP VIEW**

SYMBOL	MIN	NOM	MAX
A	0.80		1.10
A1	0.00		0.10
A2	0.80		1.00
b	0.15		0.30
c	0.10		0.18
D	1.80	2.00	2.20
E	1.80	2.10	2.40
E1	1.15	1.25	1.35
e	0.65 BSC		
L	0.26	0.36	0.46
L1	0.42 REF		
L2	0.15 BSC		
$\theta$	0°		8°
$\theta_1$	4°		10°

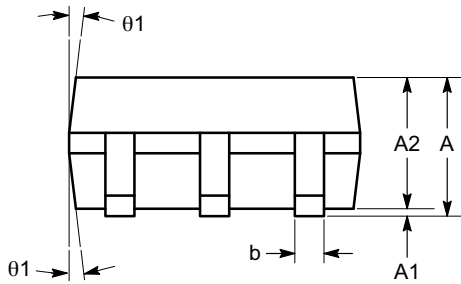

**SIDE VIEW**



**END VIEW**

**Notes:**

- (1) All dimensions are in millimeters. Angles in degrees.
- (2) Complies with JEDEC MO-203.

<b>DOCUMENT NUMBER:</b>	<b>98AON34266E</b>	Electronic versions are uncontrolled except when accessed directly from the Document Repository. Printed versions are uncontrolled except when stamped "CONTROLLED COPY" in red.
<b>DESCRIPTION:</b>	<b>SC-88 (SC-70 6 LEAD), 1.25X2</b>	<b>PAGE 1 OF 1</b>

onsemi and ONSEMI are trademarks of Semiconductor Components Industries, LLC dba onsemi or its subsidiaries in the United States and/or other countries. onsemi reserves the right to make changes without further notice to any products herein. onsemi makes no warranty, representation or guarantee regarding the suitability of its products for any particular purpose, nor does onsemi assume any liability arising out of the application or use of any product or circuit, and specifically disclaims any and all liability, including without limitation special, consequential or incidental damages. onsemi does not convey any license under its patent rights nor the rights of others.

# MECHANICAL CASE OUTLINE

## PACKAGE DIMENSIONS

ON Semiconductor®



SCALE 2:1

### UDFN8, 2x2 CASE 517AW ISSUE A

DATE 13 NOV 2015

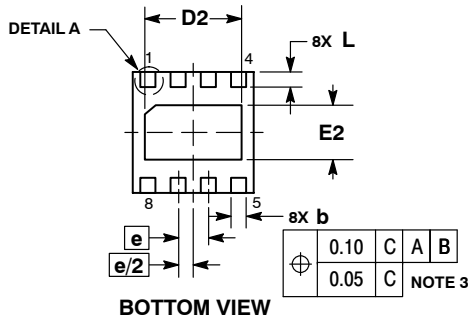
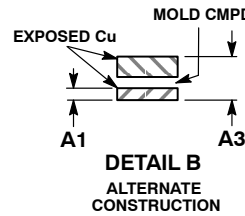
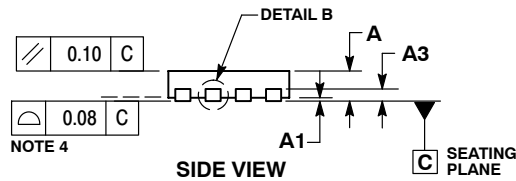
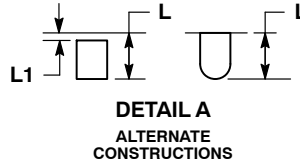
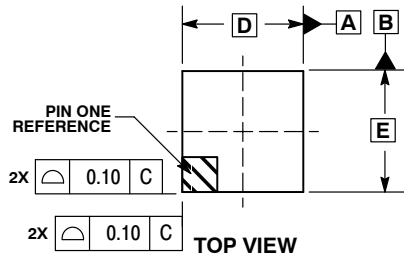

**NOTES:**

1. DIMENSIONING AND TOLERANCING PER ASME Y14.5M, 1994.
2. CONTROLLING DIMENSION: MILLIMETERS.
3. DIMENSION b APPLIES TO PLATED TERMINALS AND IS MEASURED BETWEEN 0.15 AND 0.30 MM FROM THE TERMINAL TIP.
4. COPLANARITY APPLIES TO THE EXPOSED PAD AS WELL AS THE TERMINALS.
5. FOR DEVICE OPN CONTAINING W OPTION, DETAIL B ALTERNATE CONSTRUCTION IS NOT APPLICABLE.

DIM	MILLIMETERS	
	MIN	MAX
A	0.45	0.55
A1	0.00	0.05
A3	0.13 REF	
b	0.18	0.30
D	2.00 BSC	
D2	1.50	1.70
E	2.00 BSC	
E2	0.80	1.00
e	0.50 BSC	
L	0.20	0.45
L1	---	0.15

### GENERIC MARKING DIAGRAM\*

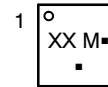

- XX = Specific Device Code
- M = Date Code
- = Pb-Free Package

(Note: Microdot may be in either location)  
 \*This information is generic. Please refer to device data sheet for actual part marking. Pb-Free indicator, "G" or microdot "▪", may or may not be present.

### RECOMMENDED SOLDERING FOOTPRINT\*

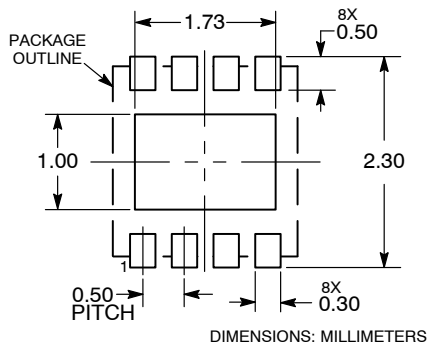

\*For additional information on our Pb-Free strategy and soldering details, please download the ON Semiconductor Soldering and Mounting Techniques Reference Manual, SOLDERRM/D.

<b>DOCUMENT NUMBER:</b>	<b>98AON34462E</b>	Electronic versions are uncontrolled except when accessed directly from the Document Repository. Printed versions are uncontrolled except when stamped "CONTROLLED COPY" in red.
<b>DESCRIPTION:</b>	<b>UDFN8, 2X2</b>	<b>PAGE 1 OF 1</b>

ON Semiconductor and ON are trademarks of Semiconductor Components Industries, LLC dba ON Semiconductor or its subsidiaries in the United States and/or other countries. ON Semiconductor reserves the right to make changes without further notice to any products herein. ON Semiconductor makes no warranty, representation or guarantee regarding the suitability of its products for any particular purpose, nor does ON Semiconductor assume any liability arising out of the application or use of any product or circuit, and specifically disclaims any and all liability, including without limitation special, consequential or incidental damages. ON Semiconductor does not convey any license under its patent rights nor the rights of others.

**onsemi**, **Onsemi**, and other names, marks, and brands are registered and/or common law trademarks of Semiconductor Components Industries, LLC dba "**onsemi**" or its affiliates and/or subsidiaries in the United States and/or other countries. **onsemi** owns the rights to a number of patents, trademarks, copyrights, trade secrets, and other intellectual property. A listing of **onsemi**'s product/patent coverage may be accessed at [www.onsemi.com/site/pdf/Patent-Marking.pdf](http://www.onsemi.com/site/pdf/Patent-Marking.pdf). **onsemi** reserves the right to make changes at any time to any products or information herein, without notice. The information herein is provided "as-is" and **onsemi** makes no warranty, representation or guarantee regarding the accuracy of the information, product features, availability, functionality, or suitability of its products for any particular purpose, nor does **onsemi** assume any liability arising out of the application or use of any product or circuit, and specifically disclaims any and all liability, including without limitation special, consequential or incidental damages. Buyer is responsible for its products and applications using **onsemi** products, including compliance with all laws, regulations and safety requirements or standards, regardless of any support or applications information provided by **onsemi**. "Typical" parameters which may be provided in **onsemi** data sheets and/or specifications can and do vary in different applications and actual performance may vary over time. All operating parameters, including "Typicals" must be validated for each customer application by customer's technical experts. **onsemi** does not convey any license under any of its intellectual property rights nor the rights of others. **onsemi** products are not designed, intended, or authorized for use as a critical component in life support systems or any FDA Class 3 medical devices or medical devices with a same or similar classification in a foreign jurisdiction or any devices intended for implantation in the human body. Should Buyer purchase or use **onsemi** products for any such unintended or unauthorized application, Buyer shall indemnify and hold **onsemi** and its officers, employees, subsidiaries, affiliates, and distributors harmless against all claims, costs, damages, and expenses, and reasonable attorney fees arising out of, directly or indirectly, any claim of personal injury or death associated with such unintended or unauthorized use, even if such claim alleges that **onsemi** was negligent regarding the design or manufacture of the part. **onsemi** is an Equal Opportunity/Affirmative Action Employer. This literature is subject to all applicable copyright laws and is not for resale in any manner.

## ADDITIONAL INFORMATION

### TECHNICAL PUBLICATIONS:

Technical Library: [www.onsemi.com/design/resources/technical-documentation](http://www.onsemi.com/design/resources/technical-documentation)  
onsemi Website: [www.onsemi.com](http://www.onsemi.com)

### ONLINE SUPPORT: [www.onsemi.com/support](http://www.onsemi.com/support)

For additional information, please contact your local Sales Representative at [www.onsemi.com/support/sales](http://www.onsemi.com/support/sales)

