

# Bipolar Transistor

(-)**50 V**, (-)**3 A**, Low  $V_{CE(sat)}$ ,  
(PNP)NPN Single **CPH6**

**CPH6123, CPH6223**

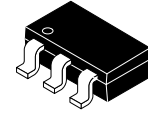

CPH6  
CASE 318BD

## 特長

- MBIT プロセス採用
- 電流容量が大きい
- コレクタ・エミッタ飽和電圧が低い
- スイッチングスピードが速い
- 超小型パッケージのため、セットの小型化、薄型化が可能である (実装高 0.9 mm)
- 許容損失が大きい
- 鉛フリー

## 用途

- DC-DC コンバータ, リレードライブ, ランプドライブ, モータドライブ, ストロボ

絶対最大定格 ( $T_A = 25^\circ\text{C}$ )

記号	項目	条件	定格値	単位
$V_{CBO}$	コレクタ・ベース電圧		(-50)100	V
$V_{CES}$	コレクタ・エミッタ電圧		(-50)100	V
$V_{CEO}$	コレクタ・エミッタ電圧		(-)50	V
$V_{EBO}$	エミッタ・ベース電圧		(-)6	V
$I_C$	コレクタ電流		(-)3	A
$I_{CP}$	コレクタ電流 (パルス)		(-)6	A
$I_B$	ベース電流		(-)600	mA
$P_C$	コレクタ損失	セラミック基板 (600 mm <sup>2</sup> × 0.8 mm) 装着時	1.3	W
$T_j$	接合部温度		150	°C
$T_{stg}$	保存周囲温度		-55 to +150	°C

Stresses exceeding those listed in the Maximum Ratings table may damage the device. If any of these limits are exceeded, device functionality should not be assumed, damage may occur and reliability may be affected.

(参考訳)

最大定格を超えるストレスは、デバイスにダメージを与える危険性があります。これらの定格値を超えた場合は、デバイスの機能性を損ない、ダメージが生じたり、信頼性に影響を及ぼす危険性があります。

## ELECTRICAL CONNECTION

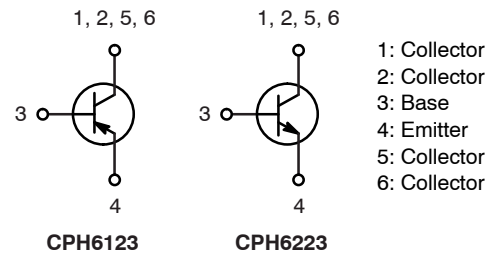

## MARKING DIAGRAMS

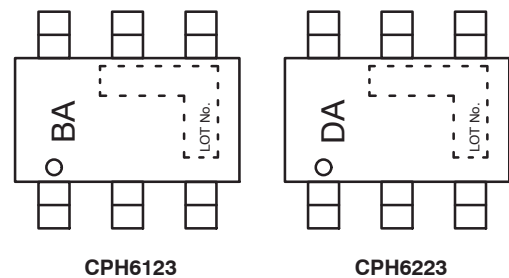

## ORDERING INFORMATION

Device	Package	Shipping†
CPH6123-TL-E	CPH6 (Pb-Free)	3 000 / Tape & Reel
CPH6223-TL-E	CPH6 (Pb-Free)	3 000 / Tape & Reel

†For information on tape and reel specifications, including part orientation and tape sizes, please refer to our Tape and Reel Packaging Specification Brochure, [BRD8011/D](#).

# CPH6123, CPH6223

電気的特性 ( $T_A = 25^\circ\text{C}$ )

記号	項目	条件	最小	標準値	最大	単位
$I_{CBO}$	コレクタしや断電流	$V_{CB} = (-)40\text{ V}, I_E = 0\text{ A}$			(-)1	$\mu\text{A}$
$I_{EBO}$	エミッタしや断電流	$V_{EB} = (-)4\text{ V}, I_C = 0\text{ A}$			(-)1	$\mu\text{A}$
$h_{FE}$	直流電流増幅率	$V_{CE} = (-)2\text{ V}, I_C = (-)100\text{ mA}$	200		560	
$f_T$	利得帯域幅積	$V_{CE} = (-)10\text{ V}, I_C = (-)500\text{ mA}$		(390) 380		MHz
$C_{ob}$	出力容量	$V_{CB} = (-)10\text{ V}, f = 1\text{ MHz}$		(24) 13		pF
$V_{CE(sat)1}$	コレクタ・エミッタ飽和電圧	$I_C = (-)1\text{ A}, I_B = (-)50\text{ mA}$		(-115) 90	(-230) 130	mV
$V_{CE(sat)2}$		$I_C = (-)2\text{ A}, I_B = (-)100\text{ mA}$		(-240) 160	(-650) 240	mV
$V_{BE(sat)}$	ベース・エミッタ飽和電圧	$I_C = (-)2\text{ A}, I_B = (-)100\text{ mA}$		(-)0.88	(-)1.2	V
$V_{(BR)CBO}$	コレクタ・ベース降伏電圧	$I_C = (-)10\text{ }\mu\text{A}, I_E = 0\text{ A}$	(-50) 100			V
$V_{(BR)CES}$	コレクタ・エミッタ降伏電圧	$I_C = (-)100\text{ }\mu\text{A}, R_{BE} = 0\text{ }\Omega$	(-50) 100			V
$V_{(BR)CEO}$	コレクタ・エミッタ降伏電圧	$I_C = (-)1\text{ mA}, R_{BE} = \infty$	(-)50			V
$V_{(BR)EBO}$	エミッタ・ベース降伏電圧	$I_E = (-)10\text{ }\mu\text{A}, I_C = 0\text{ A}$	(-)6			V
$t_{on}$	ターンオン時間	指定回路において		(30) 35		ns
$t_{stg}$	蓄積時間			(230) 300		ns
$t_f$	下降時間			(18) 25		ns

Product parametric performance is indicated in the Electrical Characteristics for the listed test conditions, unless otherwise noted. Product performance may not be indicated by the Electrical Characteristics if operated under different conditions.

(参考訳)

製品パラメータは、特別な記述が無い限り、記載されたテスト条件に対する電気的特性で示しています。異なる条件下で製品動作を行った時には、電気的特性で示している特性を得られない場合があります。



図 1. スイッチングタイム測定回路図

# CPH6123, CPH6223

## TYPICAL PERFORMANCE CHARACTERISTICS

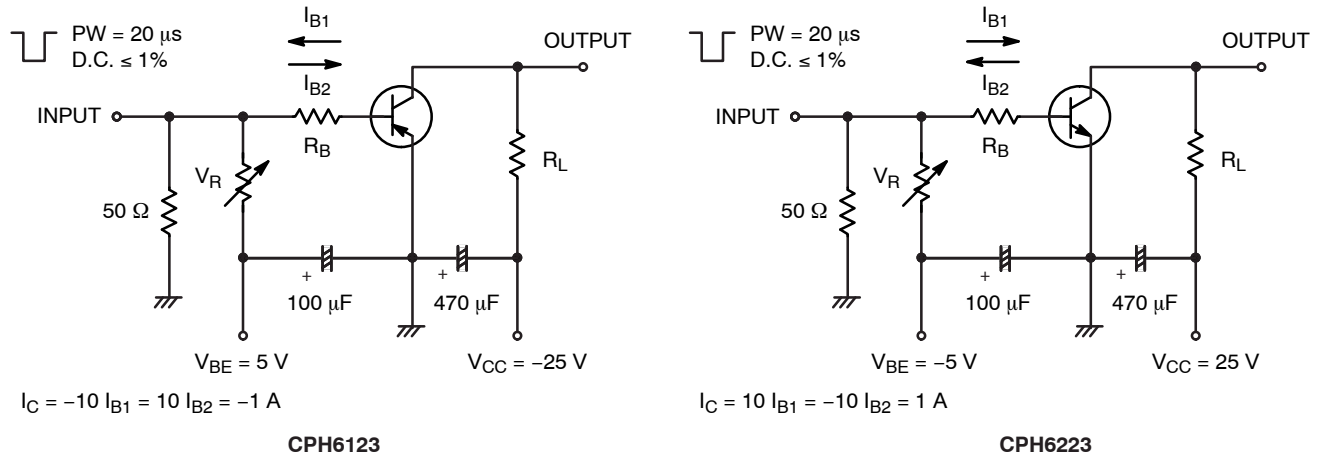

図 2.  $I_C - V_{CE}$



図 3.  $I_C - V_{CE}$

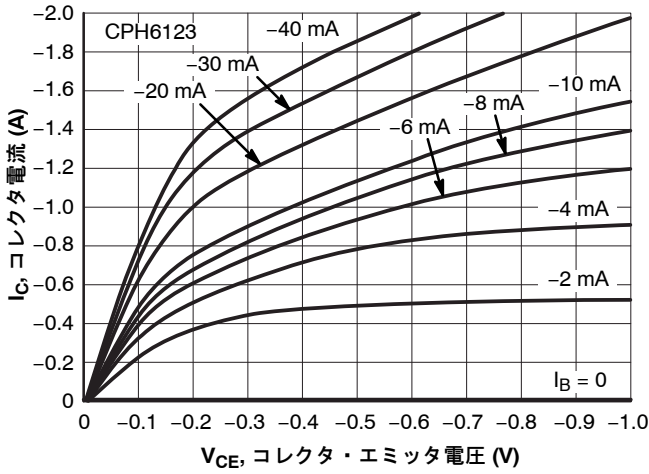

図 4.  $I_C - V_{BE}$

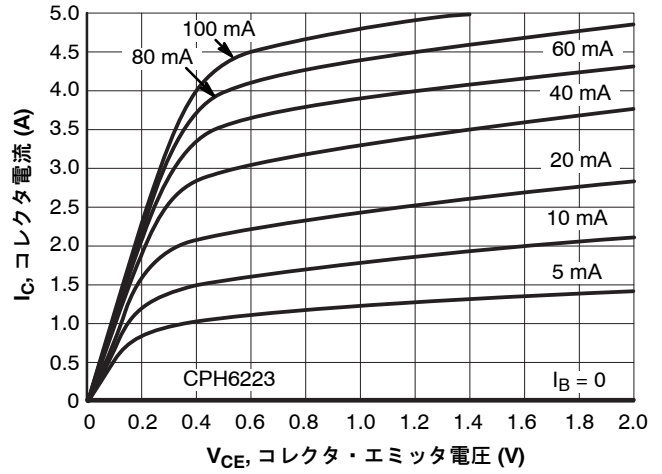

図 5.  $I_C - V_{BE}$

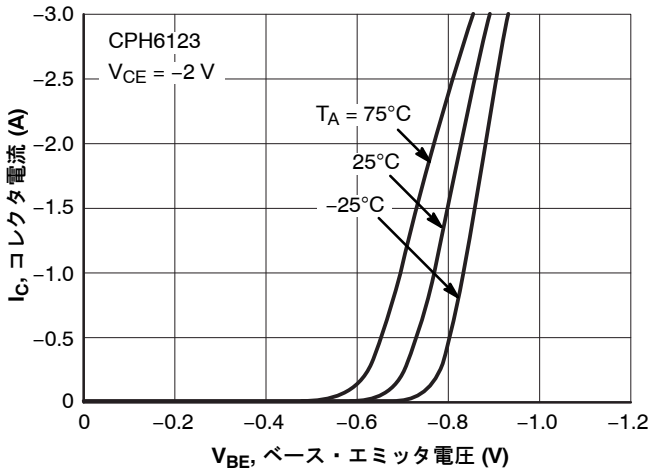

図 6.  $h_{FE} - I_C$

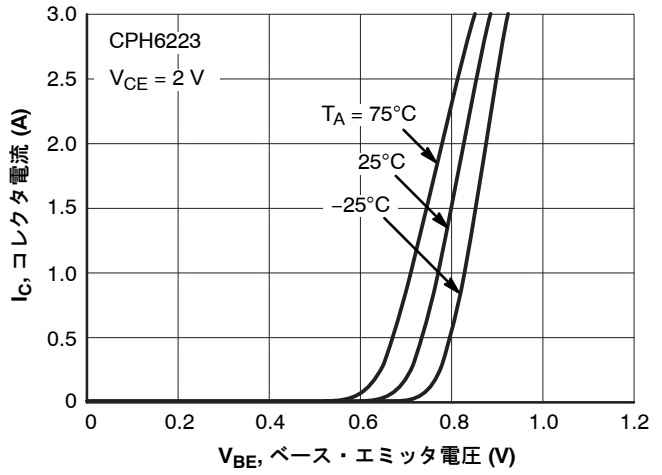

図 7.  $h_{FE} - I_C$

# CPH6123, CPH6223

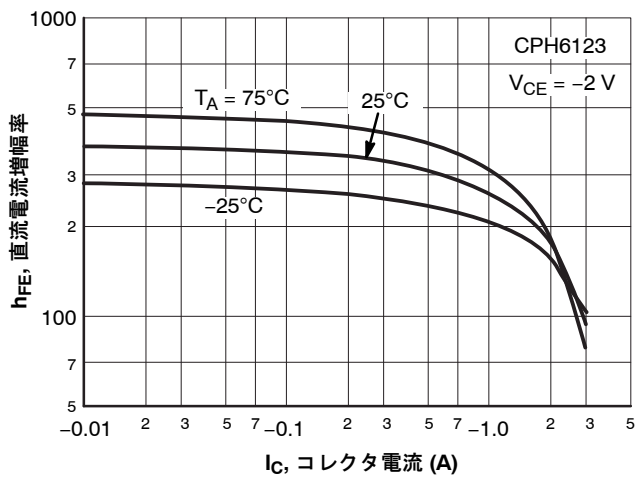
## TYPICAL PERFORMANCE CHARACTERISTICS (Continued)

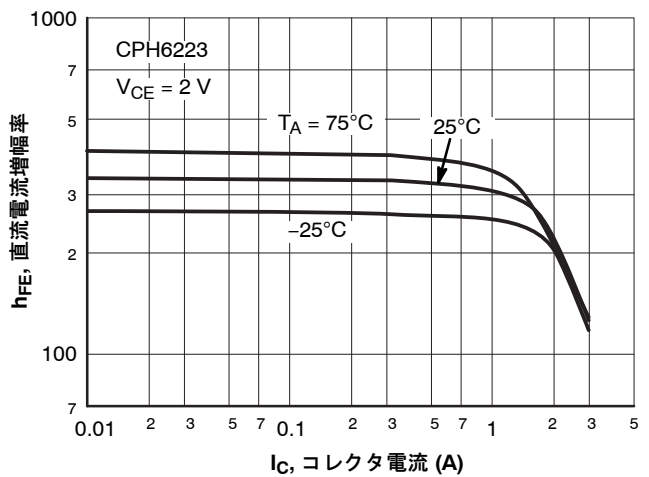

図 8.  $f_T - I_C$



図 9.  $f_T - I_C$

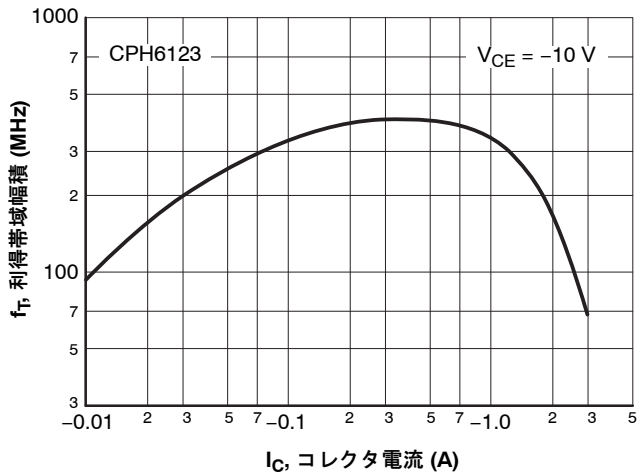

図 10.  $C_{ob} - V_{CB}$

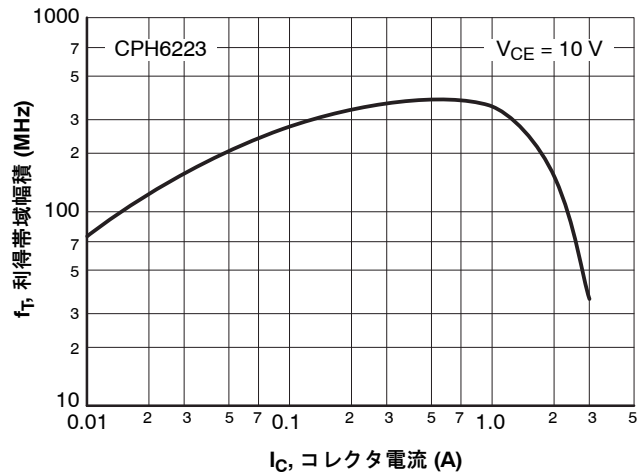

図 11.  $C_{ob} - V_{CB}$

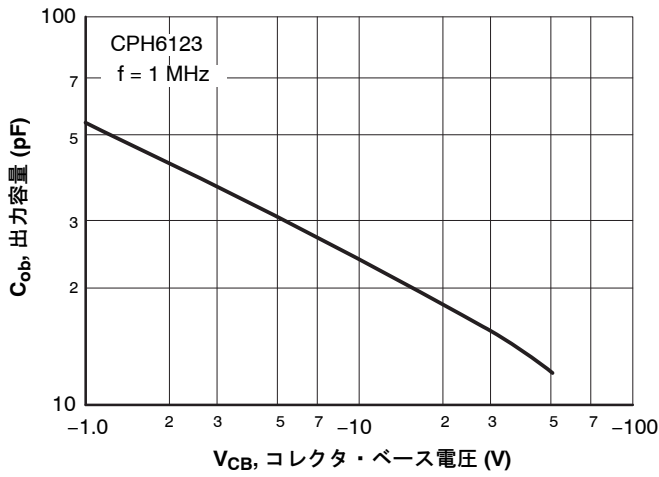

図 12.  $V_{CE(sat)} - I_C$

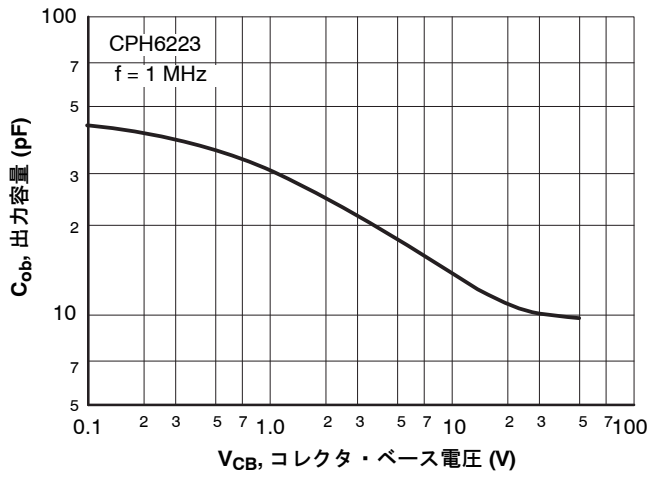

図 13.  $V_{CE(sat)} - I_C$

# CPH6123, CPH6223

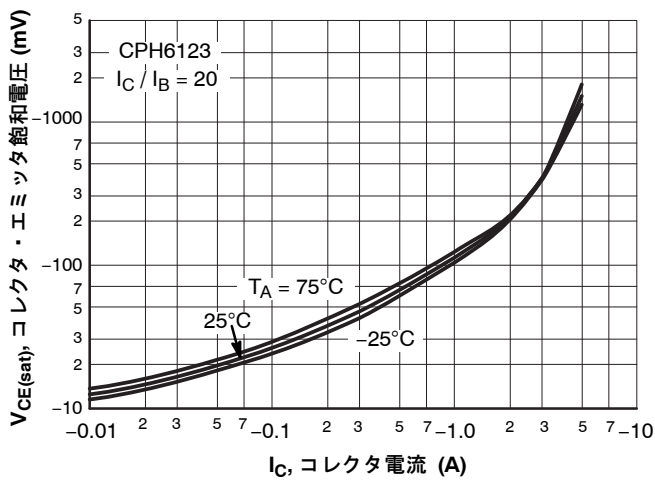
## TYPICAL PERFORMANCE CHARACTERISTICS (Continued)

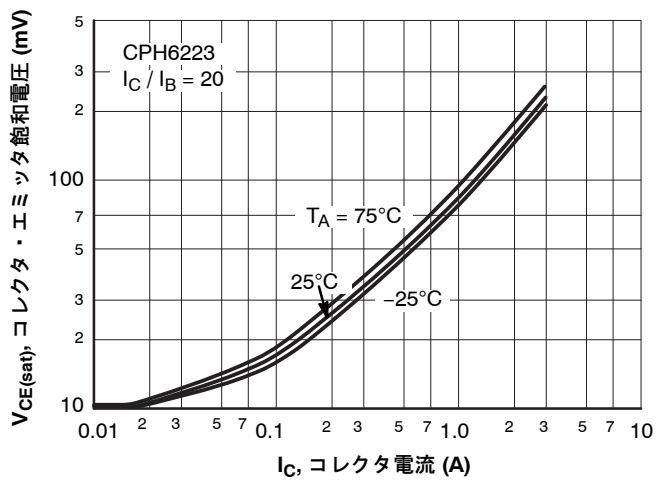

図 14.  $V_{CE(sat)} - I_C$



図 15.  $V_{CE(sat)} - I_C$

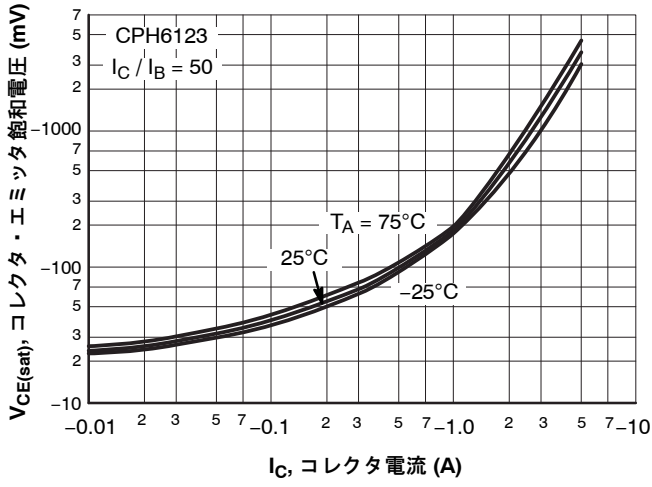

図 16.  $V_{BE(sat)} - I_C$

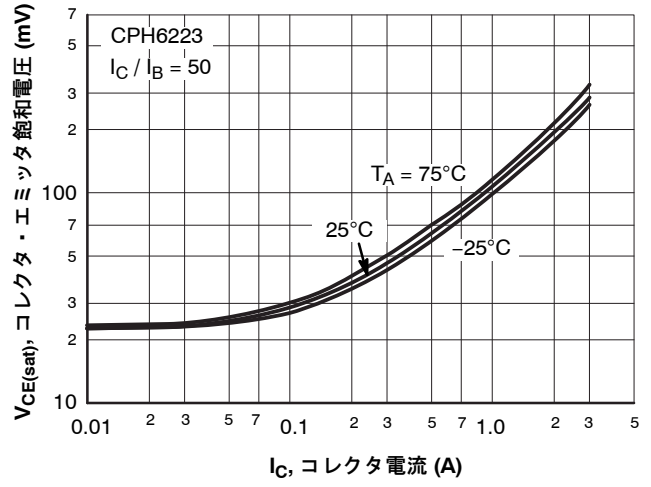

図 17.  $V_{BE(sat)} - I_C$

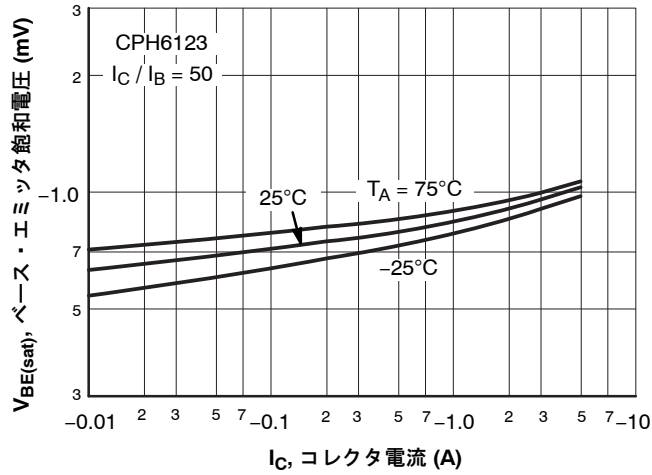

図 18. ASO

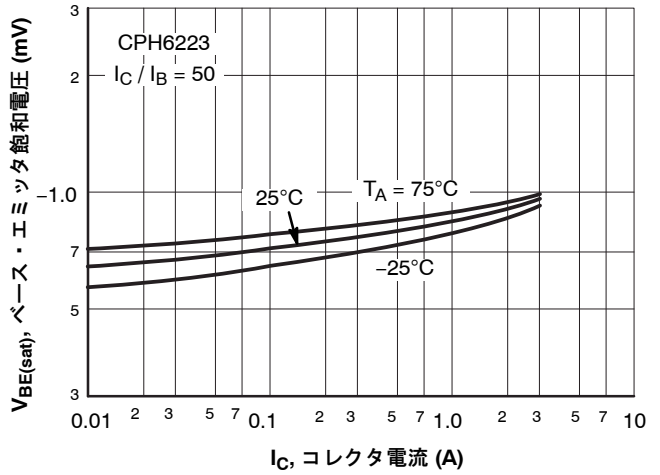

図 19. ASO

# CPH6123, CPH6223

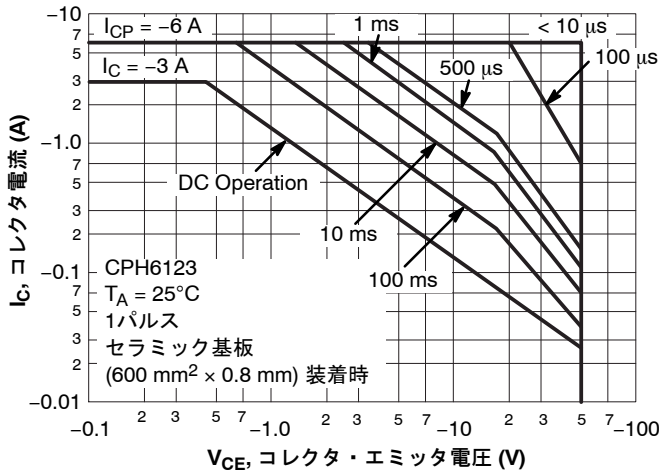
## TYPICAL PERFORMANCE CHARACTERISTICS (Continued)

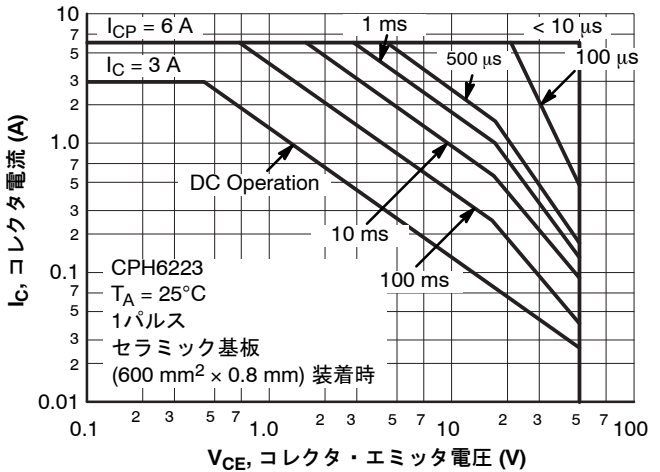

図 20.  $P_C - T_A$

**MECHANICAL CASE OUTLINE**  
**PACKAGE DIMENSIONS**

**CPH6**  
**CASE 318BD**  
**ISSUE O**

DATE 30 NOV 2011

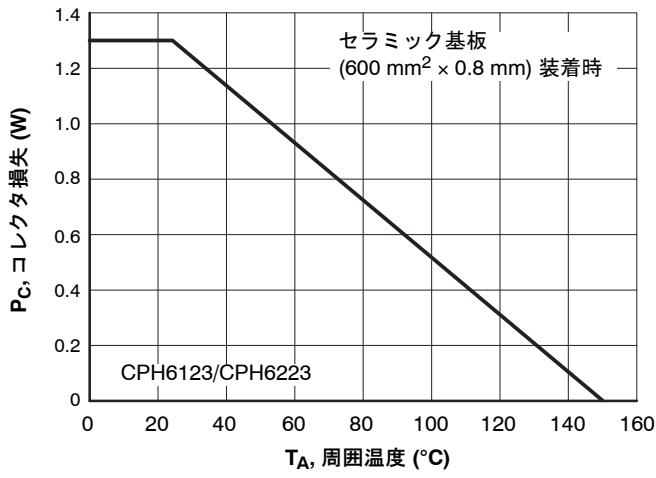
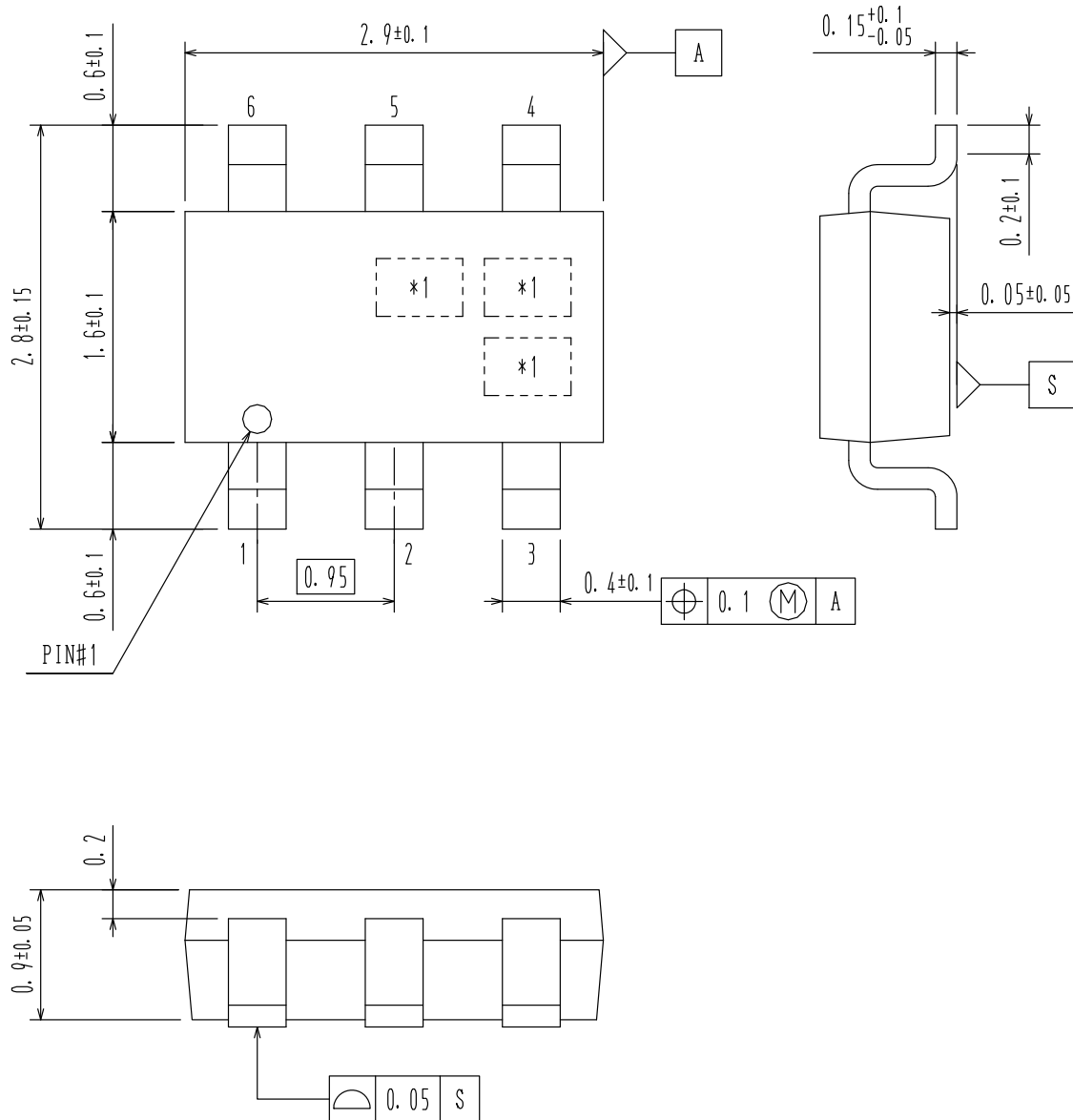

<b>DOCUMENT NUMBER:</b>	<b>98AON65440E</b>	Electronic versions are uncontrolled except when accessed directly from the Document Repository. Printed versions are uncontrolled except when stamped "CONTROLLED COPY" in red.
<b>DESCRIPTION:</b>	<b>CPH6</b>	<b>PAGE 1 OF 1</b>

ON Semiconductor and **ON** are trademarks of Semiconductor Components Industries, LLC dba ON Semiconductor or its subsidiaries in the United States and/or other countries. ON Semiconductor reserves the right to make changes without further notice to any products herein. ON Semiconductor makes no warranty, representation or guarantee regarding the suitability of its products for any particular purpose, nor does ON Semiconductor assume any liability arising out of the application or use of any product or circuit, and specifically disclaims any and all liability, including without limitation special, consequential or incidental damages. ON Semiconductor does not convey any license under its patent rights nor the rights of others.

**onsemi**, **Onsemi**, and other names, marks, and brands are registered and/or common law trademarks of Semiconductor Components Industries, LLC dba "**onsemi**" or its affiliates and/or subsidiaries in the United States and/or other countries. **onsemi** owns the rights to a number of patents, trademarks, copyrights, trade secrets, and other intellectual property. A listing of **onsemi**'s product/patent coverage may be accessed at [www.onsemi.com/site/pdf/Patent-Marking.pdf](http://www.onsemi.com/site/pdf/Patent-Marking.pdf). **onsemi** reserves the right to make changes at any time to any products or information herein, without notice. The information herein is provided "as-is" and **onsemi** makes no warranty, representation or guarantee regarding the accuracy of the information, product features, availability, functionality, or suitability of its products for any particular purpose, nor does **onsemi** assume any liability arising out of the application or use of any product or circuit, and specifically disclaims any and all liability, including without limitation special, consequential or incidental damages. Buyer is responsible for its products and applications using **onsemi** products, including compliance with all laws, regulations and safety requirements or standards, regardless of any support or applications information provided by **onsemi**. "Typical" parameters which may be provided in **onsemi** data sheets and/or specifications can and do vary in different applications and actual performance may vary over time. All operating parameters, including "Typicals" must be validated for each customer application by customer's technical experts. **onsemi** does not convey any license under any of its intellectual property rights nor the rights of others. **onsemi** products are not designed, intended, or authorized for use as a critical component in life support systems or any FDA Class 3 medical devices or medical devices with a same or similar classification in a foreign jurisdiction or any devices intended for implantation in the human body. Should Buyer purchase or use **onsemi** products for any such unintended or unauthorized application, Buyer shall indemnify and hold **onsemi** and its officers, employees, subsidiaries, affiliates, and distributors harmless against all claims, costs, damages, and expenses, and reasonable attorney fees arising out of, directly or indirectly, any claim of personal injury or death associated with such unintended or unauthorized use, even if such claim alleges that **onsemi** was negligent regarding the design or manufacture of the part. **onsemi** is an Equal Opportunity/Affirmative Action Employer. This literature is subject to all applicable copyright laws and is not for resale in any manner.

## ADDITIONAL INFORMATION

### TECHNICAL PUBLICATIONS:

Technical Library: [www.onsemi.com/design/resources/technical-documentation](http://www.onsemi.com/design/resources/technical-documentation)  
onsemi Website: [www.onsemi.com](http://www.onsemi.com)

### ONLINE SUPPORT: [www.onsemi.com/support](http://www.onsemi.com/support)

For additional information, please contact your local Sales Representative at [www.onsemi.com/support/sales](http://www.onsemi.com/support/sales)