

NSBC115TPDP6

Complementary Bias Resistor Transistors R1 = 100 kΩ, R2 = ∞ kΩ

NPN and PNP Transistors with Monolithic Bias Resistor Network

This series of digital transistors is designed to replace a single device and its external resistor bias network. The Bias Resistor Transistor (BRT) contains a single transistor with a monolithic bias network consisting of two resistors; a series base resistor and a base-emitter resistor. The BRT eliminates these individual components by integrating them into a single device. The use of a BRT can reduce both system cost and board space.

Features

- S and NSV Prefix for Automotive and Other Applications Requiring Unique Site and Control Change Requirements; AEC-Q101 Qualified and PPAP Capable
- Simplifies Circuit Design
- Reduces Board Space
- Reduces Component Count
- These Devices are Pb-Free, Halogen Free/BFR Free and are RoHS Compliant

MAXIMUM RATINGS

(T_A = 25°C both polarities Q1 (PNP) and Q2 (NPN), unless otherwise noted)

Rating	Symbol	Max	Unit
Collector-Base Voltage	V _{CBO}	50	Vdc
Collector-Emitter Voltage	V _{CEO}	50	Vdc
Collector Current - Continuous	I _C	100	mAdc
Input Forward Voltage	V _{IN(fwd)}	40	Vdc
Input Reverse Voltage	V _{IN(rev)}		Vdc
-NPN		6	
-PNP		5	

Stresses exceeding those listed in the Maximum Ratings table may damage the device. If any of these limits are exceeded, device functionality should not be assumed, damage may occur and reliability may be affected.

ORDERING INFORMATION

Device	Package	Shipping†
NSBC115TPDP6T5G	SOT-963	8,000 / Tape & Reel

†For information on tape and reel specifications, including part orientation and tape sizes, please refer to our Tape and Reel Packaging Specifications Brochure, BRD8011/D.



ON Semiconductor®

www.onsemi.com

PIN CONNECTIONS

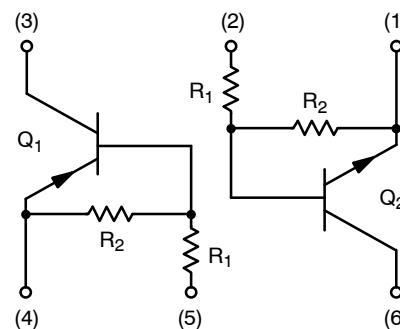

MARKING DIAGRAMS

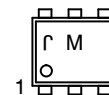

SOT-963
CASE 527AD

J = Specific Device Code
M = Date Code*

*Date Code orientation may vary depending upon manufacturing location.

NSBC115TPDP6

THERMAL CHARACTERISTICS

Characteristic	Symbol	Max	Unit
----------------	--------	-----	------

NSBC115TPDP6 (SOT-963) One Junction Heated

Total Device Dissipation $T_A = 25^\circ\text{C}$ (Note 1) (Note 2) Derate above 25°C (Note 1) (Note 2)	P_D	231 269 1.9 2.2	mW mW/ $^\circ\text{C}$
Thermal Resistance, Junction to Ambient (Note 1) (Note 2)	$R_{\theta JA}$	540 464	$^\circ\text{C}/\text{W}$

NSBC115TPDP6 (SOT-963) Both Junction Heated (Note 3)

Total Device Dissipation $T_A = 25^\circ\text{C}$ (Note 1) (Note 2) Derate above 25°C (Note 1) (Note 2)	P_D	339 408 2.7 3.3	mW mW/ $^\circ\text{C}$
Thermal Resistance, Junction to Ambient (Note 1) (Note 2)	$R_{\theta JA}$	369 306	$^\circ\text{C}/\text{W}$
Junction and Storage Temperature Range	T_J, T_{stg}	-55 to +150	$^\circ\text{C}$

1. FR-4 @ 100 mm², 1 oz. copper traces, still air.
2. FR-4 @ 500 mm², 1 oz. copper traces, still air.
3. Both junction heated values assume total power is sum of two equally powered channels.

NSBC115TPDP6

ELECTRICAL CHARACTERISTICS ($T_A = 25^\circ\text{C}$ both polarities Q_1 (PNP) and Q_2 (NPN), unless otherwise noted)

Characteristic	Symbol	Min	Typ	Max	Unit
OFF CHARACTERISTICS					
Collector-Base Cutoff Current ($V_{CB} = 50\text{ V}$, $I_E = 0$)	I_{CBO}	-	-	100	nAdc
Collector-Emitter Cutoff Current ($V_{CE} = 50\text{ V}$, $I_B = 0$)	I_{CEO}	-	-	500	nAdc
Emitter-Base Cutoff Current ($V_{EB} = 6.0\text{ V}$, $I_C = 0$)	I_{EBO}	-	-	0.1	mAdc
Collector-Base Breakdown Voltage ($I_C = 10\ \mu\text{A}$, $I_E = 0$)	$V_{(BR)CBO}$	50	-	-	Vdc
Collector-Emitter Breakdown Voltage (Note 4) ($I_C = 2.0\text{ mA}$, $I_B = 0$)	$V_{(BR)CEO}$	50	-	-	Vdc

ON CHARACTERISTICS

DC Current Gain (Note 4) ($I_C = 5.0\text{ mA}$, $V_{CE} = 10\text{ V}$)	h_{FE}	160	350	-	
Collector-Emitter Saturation Voltage (Note 4) ($I_C = 10\text{ mA}$, $I_B = 1.0\text{ mA}$)	$V_{CE(sat)}$	-	-	0.25	Vdc
Input Voltage (off) ($V_{CE} = 5.0\text{ V}$, $I_C = 100\ \mu\text{A}$) (NPN) ($V_{CE} = 5.0\text{ V}$, $I_C = 100\ \mu\text{A}$) (PNP)	$V_{i(off)}$	-	0.6 0.62	-	Vdc
Input Voltage (on) ($V_{CE} = 0.2\text{ V}$, $I_C = 1.0\text{ mA}$) (NPN) ($V_{CE} = 0.2\text{ V}$, $I_C = 1.0\text{ mA}$) (PNP)	$V_{i(on)}$	-	1.0 1.0	-	Vdc
Output Voltage (on) ($V_{CC} = 5.0\text{ V}$, $V_B = 3.5\text{ V}$, $R_L = 1.0\text{ k}\Omega$)	V_{OL}	-	-	0.2	Vdc
Output Voltage (off) ($V_{CC} = 5.0\text{ V}$, $V_B = 0.25\text{ V}$, $R_L = 1.0\text{ k}\Omega$)	V_{OH}	4.9	-	-	Vdc
Input Resistor	R_1	70	100	130	$\text{k}\Omega$
Resistor Ratio	R_1/R_2	-	-	-	

4. Pulsed Condition: Pulse Width = 300 msec, Duty Cycle $\leq 2\%$.

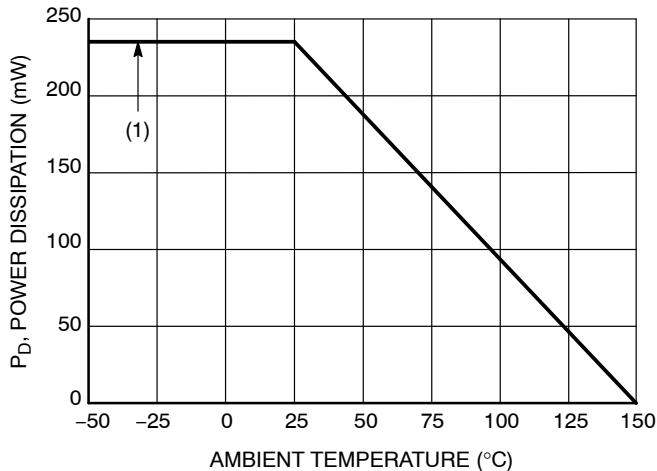

(1) SOT-963; 100 mm², 1 oz. copper trace

Figure 1. Derating Curve

NSBC115TPDP6

TYPICAL CHARACTERISTICS – NPN TRANSISTOR NSBC115TPDP6

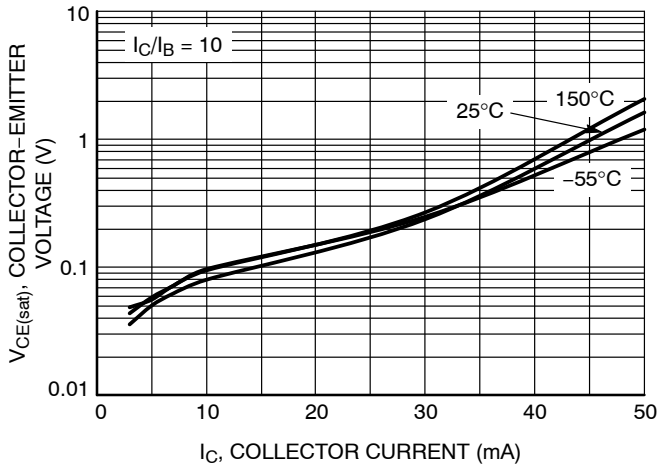

Figure 2. $V_{CE(sat)}$ vs. I_C

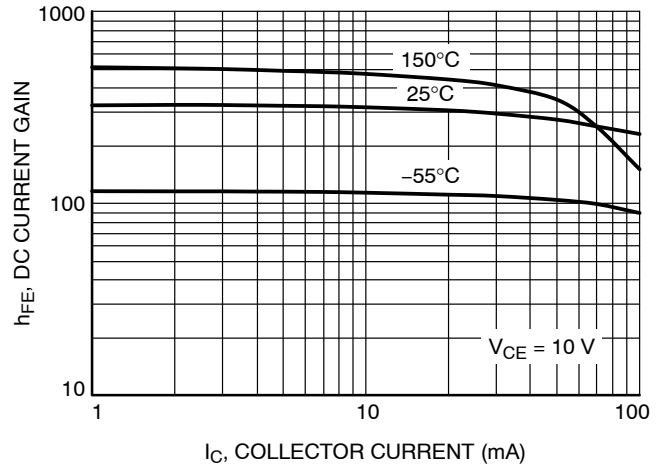

Figure 3. DC Current Gain

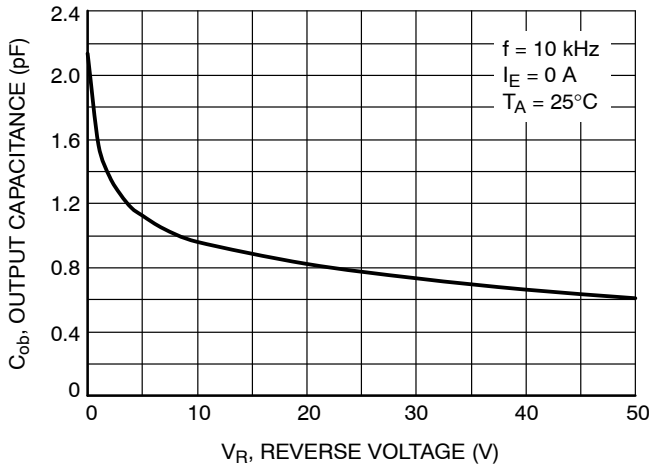

Figure 4. Output Capacitance

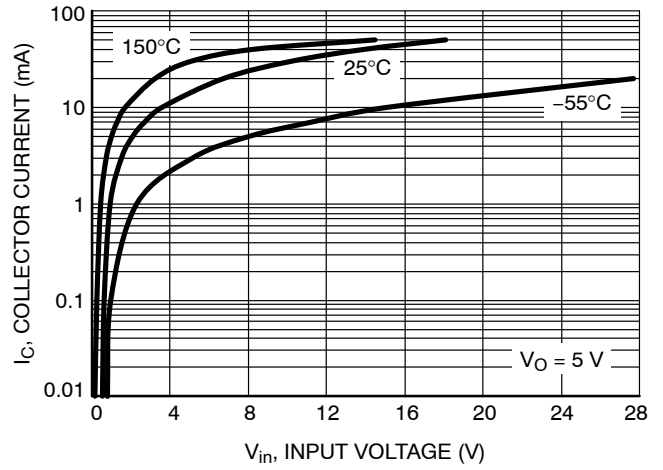

Figure 5. Output Current vs. Input Voltage

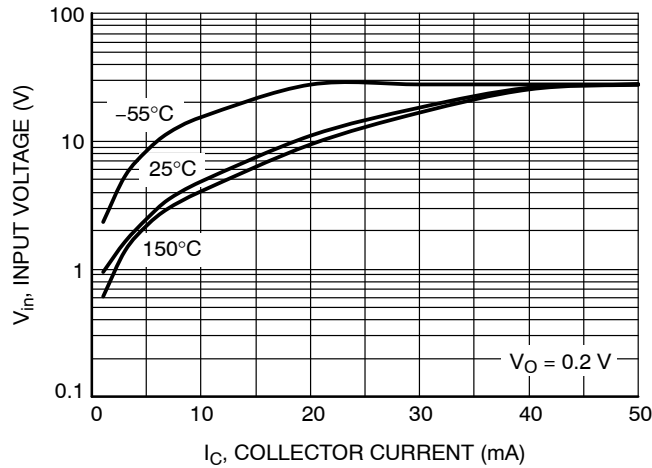

Figure 6. Input Voltage vs. Output Current

NSBC115TPDP6

TYPICAL CHARACTERISTICS – PNP TRANSISTOR NSBC115TPDP6

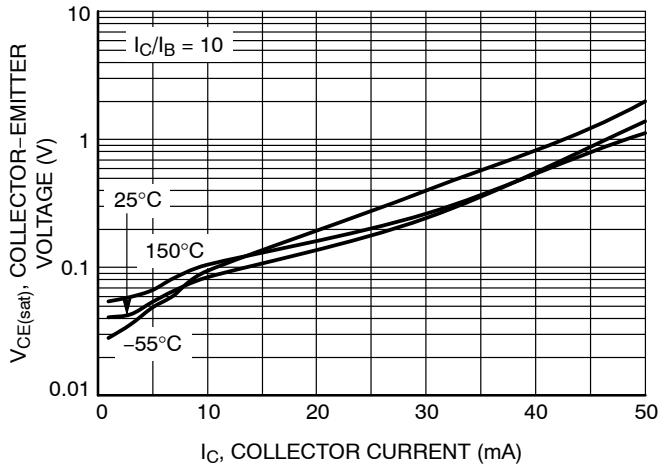

Figure 7. $V_{CE(sat)}$ vs. I_C

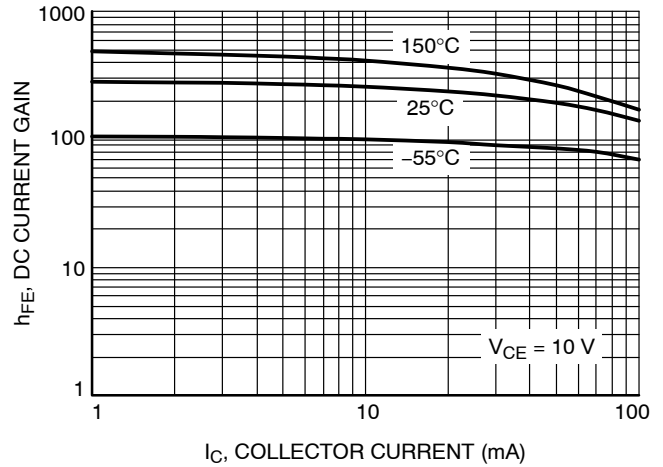

Figure 8. DC Current Gain

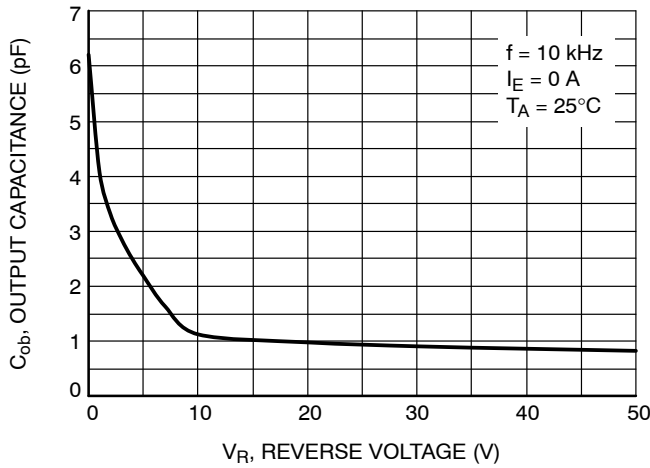

Figure 9. Output Capacitance

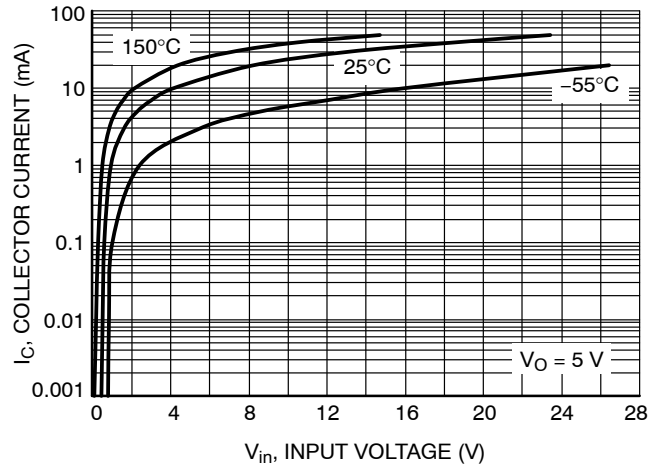

Figure 10. Output Current vs. Input Voltage

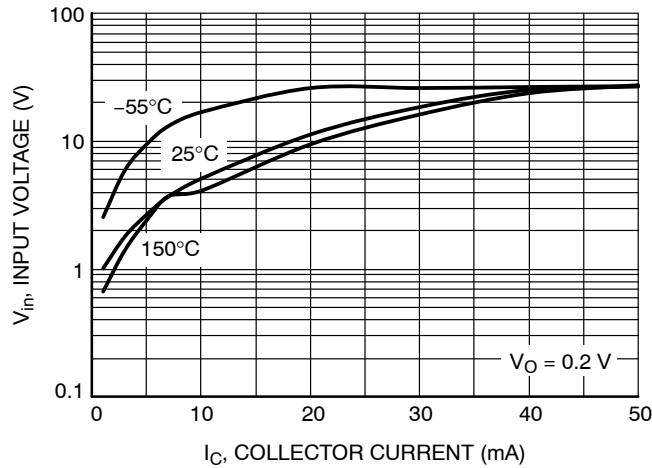
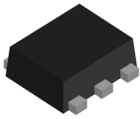

Figure 11. Input Voltage vs. Output Current

MECHANICAL CASE OUTLINE

PACKAGE DIMENSIONS



SOT-963 1.00x1.00x0.37, 0.35P
CASE 527AD
ISSUE F

DATE 20 FEB 2024

NOTES:

1. DIMENSIONING AND TOLERANCING PER ASME Y14.5M, 2018.
2. CONTROLLING DIMENSION: MILLIMETERS.
3. MAXIMUM LEAD THICKNESS INCLUDES LEAD FINISH THICKNESS. MINIMUM LEAD THICKNESS IS THE MINIMUM THICKNESS OF BASE MATERIAL.
4. DIMENSIONS D AND E DO NOT INCLUDE MOLD FLASH, PROTRUSIONS, OR GATE BURRS.

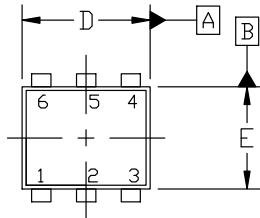

TOP VIEW

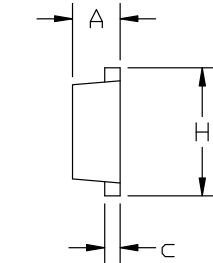

SIDE VIEW

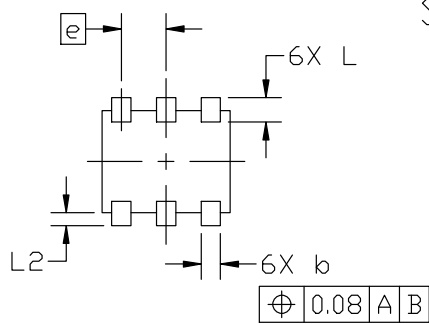

BOTTOM VIEW

DIM	MILLIMETERS		
	MIN.	NOM.	MAX.
A	0.34	0.37	0.40
b	0.10	0.15	0.20
c	0.07	0.12	0.17
D	0.95	1.00	1.05
E	0.75	0.80	0.85
e	0.35 BSC		
H	0.95	1.00	1.05
L	0.19 REF		
L2	0.05	0.10	0.15

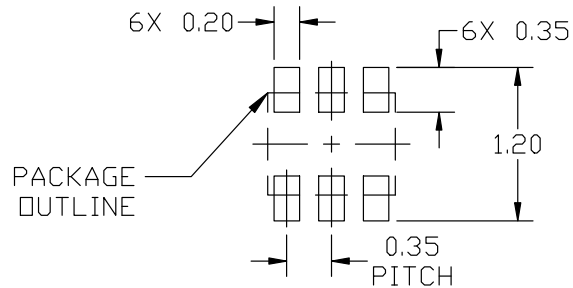

RECOMMENDED MOUNTING FOOTPRINT

*For additional information on our Pb-Free strategy and soldering details, please download the ON Semiconductor Soldering and Mounting Techniques Reference manual, SOLDERRM/D.

- | | | |
|--|---|--|
| <p>STYLE 1:
 PIN 1. EMITTER 1
 2. BASE 1
 3. COLLECTOR 2
 4. EMITTER 2
 5. BASE 2
 6. COLLECTOR 1</p> | <p>STYLE 2:
 PIN 1. EMITTER 1
 2. EMITTER2
 3. BASE 2
 4. COLLECTOR 2
 5. BASE 1
 6. COLLECTOR 1</p> | <p>STYLE 3:
 PIN 1. CATHODE 1
 2. CATHODE 1
 3. ANODE/ANODE 2
 4. CATHODE 2
 5. CATHODE 2
 6. ANODE/ANODE 1</p> |
| <p>STYLE 4:
 PIN 1. COLLECTOR
 2. COLLECTOR
 3. BASE
 4. EMITTER
 5. COLLECTOR
 6. COLLECTOR</p> | <p>STYLE 5:
 PIN 1. CATHODE
 2. CATHODE
 3. ANODE
 4. ANODE
 5. CATHODE
 6. CATHODE</p> | <p>STYLE 6:
 PIN 1. CATHODE
 2. ANODE
 3. CATHODE
 4. CATHODE
 5. CATHODE
 6. CATHODE</p> |
| <p>STYLE 7:
 PIN 1. CATHODE
 2. ANODE
 3. CATHODE
 4. CATHODE
 5. ANODE
 6. CATHODE</p> | <p>STYLE 8:
 PIN 1. DRAIN
 2. DRAIN
 3. GATE
 4. SOURCE
 5. DRAIN
 6. DRAIN</p> | <p>STYLE 9:
 PIN 1. SOURCE 1
 2. GATE 1
 3. DRAIN 2
 4. SOURCE 2
 5. GATE 2
 6. DRAIN 1</p> |
| <p>STYLE 10:
 PIN 1. CATHODE 1
 2. N/C
 3. CATHODE 2
 4. ANODE 2
 5. N/C
 6. ANODE 1</p> | | |

GENERIC MARKING DIAGRAM*

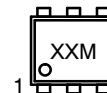

XX = Specific Device Code
 M = Month Code

*This information is generic. Please refer to device data sheet for actual part marking. Pb-Free indicator, "G" or microdot "•", may or may not be present. Some products may not follow the Generic Marking.

DOCUMENT NUMBER:	98AON26456D	Electronic versions are uncontrolled except when accessed directly from the Document Repository. Printed versions are uncontrolled except when stamped "CONTROLLED COPY" in red.
DESCRIPTION:	SOT-963 1.00x1.00x0.37, 0.35P	PAGE 1 OF 1

onsemi and ONSEMI are trademarks of Semiconductor Components Industries, LLC dba onsemi or its subsidiaries in the United States and/or other countries. onsemi reserves the right to make changes without further notice to any products herein. onsemi makes no warranty, representation or guarantee regarding the suitability of its products for any particular purpose, nor does onsemi assume any liability arising out of the application or use of any product or circuit, and specifically disclaims any and all liability, including without limitation special, consequential or incidental damages. onsemi does not convey any license under its patent rights nor the rights of others.

onsemi, **Onsemi**, and other names, marks, and brands are registered and/or common law trademarks of Semiconductor Components Industries, LLC dba "**onsemi**" or its affiliates and/or subsidiaries in the United States and/or other countries. **onsemi** owns the rights to a number of patents, trademarks, copyrights, trade secrets, and other intellectual property. A listing of **onsemi**'s product/patent coverage may be accessed at www.onsemi.com/site/pdf/Patent-Marking.pdf. **onsemi** reserves the right to make changes at any time to any products or information herein, without notice. The information herein is provided "as-is" and **onsemi** makes no warranty, representation or guarantee regarding the accuracy of the information, product features, availability, functionality, or suitability of its products for any particular purpose, nor does **onsemi** assume any liability arising out of the application or use of any product or circuit, and specifically disclaims any and all liability, including without limitation special, consequential or incidental damages. Buyer is responsible for its products and applications using **onsemi** products, including compliance with all laws, regulations and safety requirements or standards, regardless of any support or applications information provided by **onsemi**. "Typical" parameters which may be provided in **onsemi** data sheets and/or specifications can and do vary in different applications and actual performance may vary over time. All operating parameters, including "Typicals" must be validated for each customer application by customer's technical experts. **onsemi** does not convey any license under any of its intellectual property rights nor the rights of others. **onsemi** products are not designed, intended, or authorized for use as a critical component in life support systems or any FDA Class 3 medical devices or medical devices with a same or similar classification in a foreign jurisdiction or any devices intended for implantation in the human body. Should Buyer purchase or use **onsemi** products for any such unintended or unauthorized application, Buyer shall indemnify and hold **onsemi** and its officers, employees, subsidiaries, affiliates, and distributors harmless against all claims, costs, damages, and expenses, and reasonable attorney fees arising out of, directly or indirectly, any claim of personal injury or death associated with such unintended or unauthorized use, even if such claim alleges that **onsemi** was negligent regarding the design or manufacture of the part. **onsemi** is an Equal Opportunity/Affirmative Action Employer. This literature is subject to all applicable copyright laws and is not for resale in any manner.

ADDITIONAL INFORMATION

TECHNICAL PUBLICATIONS:

Technical Library: www.onsemi.com/design/resources/technical-documentation
onsemi Website: www.onsemi.com

ONLINE SUPPORT: www.onsemi.com/support

For additional information, please contact your local Sales Representative at www.onsemi.com/support/sales