

ON Semiconductor

Is Now

onsemi™

To learn more about onsemi™, please visit our website at
www.onsemi.com

onsemi and **onsemi** and other names, marks, and brands are registered and/or common law trademarks of Semiconductor Components Industries, LLC dba "**onsemi**" or its affiliates and/or subsidiaries in the United States and/or other countries. **onsemi** owns the rights to a number of patents, trademarks, copyrights, trade secrets, and other intellectual property. A listing of **onsemi** product/patent coverage may be accessed at www.onsemi.com/site/pdf/Patent-Marking.pdf. **onsemi** reserves the right to make changes at any time to any products or information herein, without notice. The information herein is provided "as-is" and **onsemi** makes no warranty, representation or guarantee regarding the accuracy of the information, product features, availability, functionality, or suitability of its products for any particular purpose, nor does **onsemi** assume any liability arising out of the application or use of any product or circuit, and specifically disclaims any and all liability, including without limitation special, consequential or incidental damages. Buyer is responsible for its products and applications using **onsemi** products, including compliance with all laws, regulations and safety requirements or standards, regardless of any support or applications information provided by **onsemi**. "Typical" parameters which may be provided in **onsemi** data sheets and/or specifications can and do vary in different applications and actual performance may vary over time. All operating parameters, including "Typicals" must be validated for each customer application by customer's technical experts. **onsemi** does not convey any license under any of its intellectual property rights nor the rights of others. **onsemi** products are not designed, intended, or authorized for use as a critical component in life support systems or any FDA Class 3 medical devices or medical devices with a same or similar classification in a foreign jurisdiction or any devices intended for implantation in the human body. Should Buyer purchase or use **onsemi** products for any such unintended or unauthorized application, Buyer shall indemnify and hold **onsemi** and its officers, employees, subsidiaries, affiliates, and distributors harmless against all claims, costs, damages, and expenses, and reasonable attorney fees arising out of, directly or indirectly, any claim of personal injury or death associated with such unintended or unauthorized use, even if such claim alleges that **onsemi** was negligent regarding the design or manufacture of the part. **onsemi** is an Equal Opportunity/Affirmative Action Employer. This literature is subject to all applicable copyright laws and is not for resale in any manner. Other names and brands may be claimed as the property of others.

FAN5909

Multi-Mode Buck Converter with LDO Assist for GSM / EDGE, 3 G/3.5 G and 4 G PAs



ON Semiconductor®

www.onsemi.com

Description

The FAN5909 is a high-efficiency, low-noise, synchronous, step-down, DC-DC converter optimized for powering Radio Frequency (RF) Power Amplifiers (PAs) in handsets and other mobile applications. Load currents up to 2.5 A are allowed, which enables GSM / EDGE, 3 G/3.5 G, and 4G platforms under very poor VSWR conditions.

The output voltage may be dynamically adjusted from 0.40 V to 3.60 V, proportional to an analog input voltage V_{CON} ranging from 0.16 V to 1.44 V, optimizing power-added efficiency. Fast transition times of less than 6 μ s are achieved, allowing excellent inter-slot settling.

An integrated LDO is automatically enabled under heavy load conditions or when the battery voltage and voltage drop across the DC-DC PMOS device are within a set range of the desired output voltage. This LDO-assist feature supports heavy load currents under the most stringent battery and V_{SWR} conditions while maintaining high efficiency, low dropout, and superior spectral performance.

The FAN5909 DC-DC operates in PWM Mode with a 2.9 MHz switching frequency and supports a single, small form-factor inductor ranging from 1.0 μ H to 2.2 μ H. In addition, PFM operation is allowed at low load currents for output voltages below 1.5 V to maximize efficiency. PFM operation can be disabled by setting MODE pin to LOW.

When output regulation is not required, the FAN5909 may be placed in Sleep Mode by setting V_{CON} below 100 mV nominally. This ensures a very low I_Q (<50 μ A) while enabling a fast return to output regulation.

FAN5909 is available in a low profile, small form factor, 16 bump, Wafer-Level Chip-Scale Package (WLCSP) that is 1.615 mm x 1.615 mm. Only three external components are required: two 0402 capacitors and one 2016 inductor.

Features

- Solution Size < 9.52 mm²
- 2.7 V to 5.5 V Input Voltage Range
- V_{OUT} Range from 0.40 V to 3.60 V (or V_{IN})
- Single, Small Form-Factor Inductor
- 29 m Ω Integrated LDO
- 100% Duty Cycle for Low-Dropout Operation



1
WLCSP
16 BUMP
CASE 567SD

- Input Under-Voltage Lockout / Thermal Shutdown
- 1.615 mm x 1.615 mm, 16-Bump, 0.4 mm Pitch WLCSP
- 2.9 MHz PWM Mode
- 6 μ s Output Voltage Step Response for early Tx Power-Loop Settling with 14 μ F Load Capacitance
- Sleep Mode for ~50 μ A Standby Current Consumption
- Forced PWM Mode
 - ♦ Up to 95% Efficient Synchronous Operation in High Power Conditions
 - ♦ 2.9 MHz PWM-Only Mode
- Auto PFM/PWM Mode
 - ♦ 2.9 MHz PWM Operation at High Power and PFM Operation at Low Power and Low Output Voltage for Maximum Low Current Efficiency

Applications

- Dynamic Supply Bias for Polar or Linear GSM / EDGE PAs and 3 G/3.5 G and 4 G PAs
- Dynamic Supply Bias for GSM / EDGE Quad Band Amplifiers for Mobile Handsets and Data Cards

FAN5909

ORDERING INFORMATION

Part Number	Output Voltage	Temperature Range	Package	Packing†
FAN5909UCX	0.4 V to PVIN	-40°C to +85°C	1.615 mm x 1.615 mm, 16-Bump 0.4 mm Pitch, Wafer-Level Chip-Scale Package (WLCSP)	Tape and Reel

†For information on tape and reel specifications, including part orientation and tape sizes, please refer to our Tape and Reel Packaging Specifications Brochure, BRD8011/D.

Block Diagrams

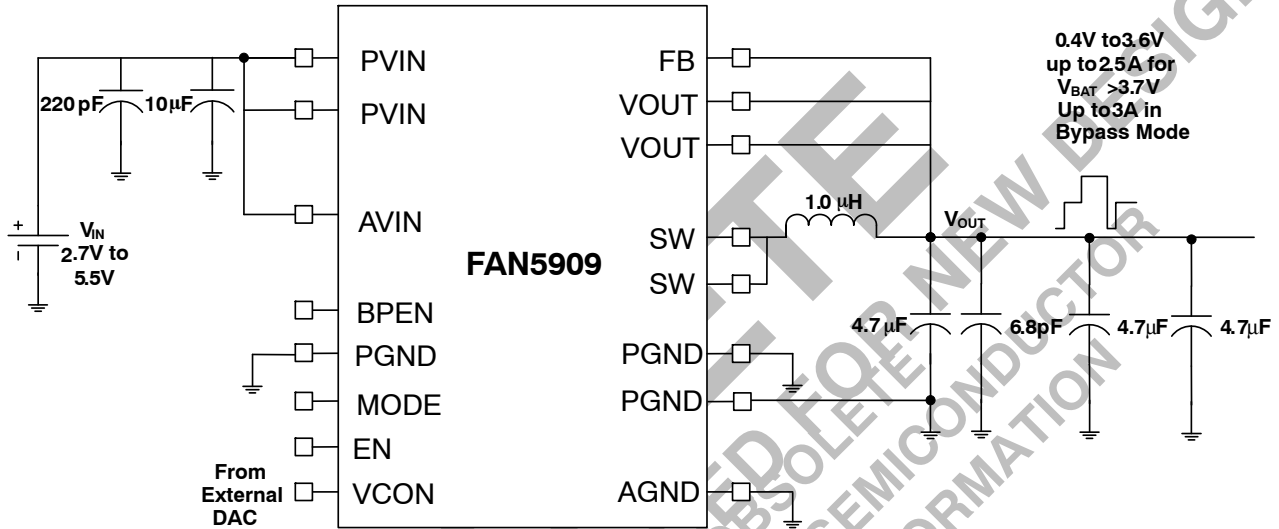

Figure 1. Typical Application

1. The three 4.7 μF capacitors include the FAN5909 output capacitor and PA bypass capacitors.
2. Regulator requires only one 4.7 μF ; the V_{OUT} bus should not exceed 14 μF capacitance over DC bias and temperature.

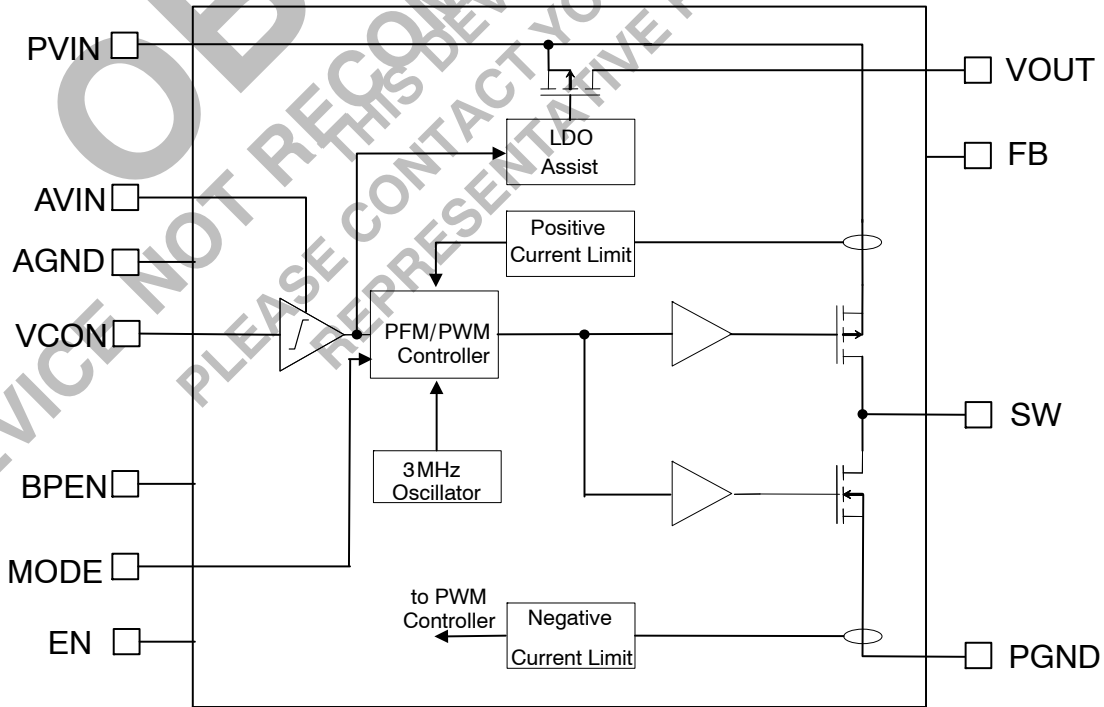

Figure 2. Simplified Block Diagram

FAN5909

Pin Configuration

PGND A1	SW A2	PVIN A3	VOUT A4
B1	B2	B3	B4
AGND C1	EN C2	BPEN C3	PGND C4
AVIN D1	VCON D2	MODE D3	FB D4

Figure 3. Bumps Face Down – Top-Through View

VOUT A4	PVIN A3	SW A2	PGND A1
B4	B3	B2	B1
PGND C4	BPEN C3	EN C2	AGND C1
FB D4	MODE D3	VCON D2	AVIN D1

Figure 4. Bumps Face Up

PIN DEFINITIONS

Pin #	Name	Description
C1	AGND	Analog ground, reference ground for the IC. Follow PCB routing notes for connecting this pin.
A4, B4	VOUT	Output voltage sense pin. Connect to V_{OUT} to establish feedback path for regulation point. Connect together on PCB.
D4	FB	Feedback pin. Connect to positive (+) pad of C_{OUT} on V_{OUT} .
C2	EN	Enables switching when HIGH; Shutdown Mode when LOW. This pin should not be left floating.
D2	VCON	Analog control pin. Shield signal routing against noise.
D1	AVIN	Analog supply voltage input. Connect to PVIN.
C3	BPEN	Force Bypass Mode when HIGH; Auto Bypass Mode when LOW. This pin should not be left floating.
D3	MODE	When MODE is HIGH, the DC-DC permits PFM operation under low load currents and PWM operation under heavy load currents. When MODE pin is set LOW, the DC-DC operates in forced PWM operation. This pin should not be left floating.
A3, B3	PVIN	Supply voltage input to the internal MOSFET switches. Connect to input power source.
A2, B2	SW	Switching node of the internal MOSFET switches. Connect to output inductor.
A1, B1, C4	PGND	Power ground of the internal MOSFET switches. Follow routing notes for connections between PGND and AGND.

Table 1. ABSOLUTE MAXIMUM RATINGS

Symbol	Parameter	Min	Max	Unit
V _{IN}	Voltage on AVIN, PVIN	-0.3	6.0	V
	Voltage on Any Other Pin	-0.3	AV _{IN} + 0.3	
T _J	Junction Temperature	-40	+125	°C
T _{STG}	Storage Temperature	-65	+150	°C
T _L	Lead Soldering Temperature (10 Seconds)		+260	°C
ESD	Electrostatic Discharge Protection Level	Human Body Model, JESD22-A114	2.0	kV
		Charged Device Model, JESD22-C101	1.0	
LU	Latch Up	JESD 78D		

Stresses exceeding those listed in the Maximum Ratings table may damage the device. If any of these limits are exceeded, device functionality should not be assumed, damage may occur and reliability may be affected.

Table 2. RECOMMENDED OPERATING CONDITIONS

Symbol	Parameter	Min	Typ	Max	Unit
V _{IN}	Supply Voltage Range	2.7		5.5	V
V _{OUT}	Output Voltage Range	0.35		<V _{IN}	V
I _{OUT_BYPASS}	Output Current in Bypass Mode (100% Duty Cycle)			4.5	A
I _{OUT}	Output Current			3.0	A
L	Inductor		1		μH
C _{IN}	Input Capacitor (Note 3)		10		μF
C _{OUT}	Output Capacitor (Note 4)		4.7		μF
T _A	Operating Ambient Temperature Range	-40		+85	°C
T _J	Operating Junction Temperature Range	-40		+125	°C

Functional operation above the stresses listed in the Recommended Operating Ranges is not implied. Extended exposure to stresses beyond the Recommended Operating Ranges limits may affect device reliability.

- The input capacitor must be large enough to limit the input voltage drop during GSM bursts, bypass transitions, and large output voltage transitions.
- Regulator requires only one 4.7 μF; the V_{OUT} bus should not exceed 14 μF capacitance over DC bias and temperature.

Table 3. DISSIPATION RATINGS

Symbol	Parameter	Min	Typ	Max	Unit
θ _{JA}	Junction-to-Ambient Thermal Resistance (Note 5)		40		°C/W

- Junction-to-ambient thermal resistance is a function of application and board layout. This data is measured with four-layer 2s2p boards with vias in accordance to JE51- JEDEC standard. Special attention must be paid not to exceed junction temperature T_{J(MAX)} at a given ambient temperature T_A.

FAN5909

Table 4. ELECTRICAL CHARACTERISTICS, ALL MODES Recommended operating conditions, unless otherwise noted, circuit per Figure 1, $V_{IN} = 2.7\text{ V}$ to 5.5 V , $T_A = -40^\circ\text{C}$ to $+85^\circ\text{C}$. Typical values are given $V_{IN} = 3.8\text{ V}$ at $T_A = 25^\circ\text{C}$. $L = 1\ \mu\text{H}$, Toko DFE201610C, $C_{IN} = 10\ \mu\text{F}$ 0402 TDK C1005X5R0J106MT, $C_{OUT} = 3 \times 4.7\ \mu\text{F}$ 0402 TDK C1005X5R0J475KT.

Symbol	Parameter	Condition	Min	Typ	Max	Unit
POWER SUPPLIES						
V_{IN}	Input Voltage Range	$I_{OUT} \leq 2.5\text{ A}$	2.7		5.5	V
I_{SD}	Shutdown Supply Current	$EN = 0\text{ V}$, $MODE = 0$		0.5	3.0	μA
V_{UVLO}	Under Voltage Lockout Threshold	V_{IN} Rising	2.20	2.45	2.60	V
		Hysteresis		250		mV
LOGIC CONTROL						
V_{IH}	Logic Threshold Voltage; EN, BPEN, MODE	Input HIGH Threshold	1.2			V
V_{IL}		Input LOW Threshold			0.4	V
I_{CTRL}	Logic Control Input Bias Current; EN, BPEN, MODE	V_{IN} or GND		0.01	1.00	μA
ANALOG CONTROL						
$V_{CON_LDO_EN1}$	V_{CON} Forced Bypass Enter (Note 6)	V_{CON} Voltage that Forces Bypass; $V_{IN} = 4.0\text{ V} - 4.75\text{ V}$	1.6			V
$V_{CON_LDO_EN2}$	V_{CON} Forced Bypass Enter (Note 6)	V_{CON} Voltage that Forces Bypass; $V_{IN} \approx V_{OUT}$		$V_{IN}/2.5$		V
$V_{CON_LDO_EX}$	V_{CON} Forced Bypass Exit	V_{CON} Voltage that Exits Forced Bypass; $V_{IN} = 2.70\text{ V} - 4.75\text{ V}$			1.4	V
$V_{con_SL_en}$	V_{con} Sleep Enter	V_{CON} Voltage Forcing Low I_Q Sleep Mode	70			mV
$V_{con_SL_ex}$	V_{con} Sleep Exit	V_{CON} Voltage that Exits SLEEP Mode			125	mV
I_Q	DC-DC Quiescent Current in Sleep Mode	$V_{CON} < 70\text{ mV}$		50	80	μA
Gain	Gain in Control Range 0.16 V to 1.44 V			2.5		
V_{OUT_ACC}	V_{OUT} Accuracy	Ideal = $2.5 \times V_{CON}$	-50		+50	mV
LDO						
R_{FET}	LDO FET Resistance			29		$\text{m}\Omega$
ΔV_{OUT_LDO}	LDO Dropout (Note 7)	$I_{OUT} = 2.0\text{ A}$		100		mV
OVER TEMPERATURE PROTECTION						
T_{OTP}	Over-Temperature Protection	Rising Temperature		+150		$^\circ\text{C}$
		Hysteresis		+20		$^\circ\text{C}$
OSCILLATOR						
f_{SW}	Average Oscillator Frequency		2.6	2.9	3.2	MHz
DC-DC						
R_{DSON}	PMOS On Resistance	$V_{IN} = V_{GS} = 3.7\text{ V}$		80		$\text{m}\Omega$
	NMOS On Resistance	$V_{IN} = V_{GS} = 3.7\text{ V}$		60		
I_{LIMp}	P-Channel Current Limit (Note 8)		1.50	1.90	2.30	A
I_{LIMn}	N-Channel Current Limit (Note 8)		1.50	1.90	2.30	A
$I_{Discharge}$	Maximum Transient Discharge Current			3.7	4.5	A
I_{LIMLDO}	LDO Current Limit				4.5	A

6. Input voltages nominally exceeding the lesser of $V_{IN}/2.5$ or 1.6 V force 100% duty cycle.

7. Dropout depends on LDO and DC-DC PFET R_{DSON} and inductor DCR.

8. The current limit is the peak (maximum) current.

9. Guaranteed by design. Maximum values are based on simulation results with 50% C_{OUT} derating; not tested in production. Voltage transient only. Assumes $C_{OUT} = 3 \times 4.7\ \mu\text{F}$ ($1 \times 4.7\ \mu\text{F}$ for regulator and $2 \times 4.7\ \mu\text{F}$ for PA decoupling capacitors).

10. Protects part under short-circuit conditions

FAN5909

Table 4. ELECTRICAL CHARACTERISTICS, ALL MODES Recommended operating conditions, unless otherwise noted, circuit per Figure 1, $V_{IN} = 2.7\text{ V to }5.5\text{ V}$, $T_A = -40^\circ\text{C to }+85^\circ\text{C}$. Typical values are given $V_{IN} = 3.8\text{ V}$ at $T_A = 25^\circ\text{C}$. $L = 1\ \mu\text{H}$, Toko DFE201610C, $C_{IN} = 10\ \mu\text{F}$ 0402 TDK C1005X5R0J106MT, $C_{OUT} = 3 \times 4.7\ \mu\text{F}$ 0402 TDK C1005X5R0J475KT.

Symbol	Parameter	Condition	Min	Typ	Max	Unit
DC-DC						
V_{OUT_MIN}	Minimum Output Voltage	$V_{CON} = 0.16\text{ V}$	0.35	0.40	0.45	V
V_{OUT_MAX}	Maximum Output Voltage	$V_{CON} = 1.44\text{ V}$, $V_{IN} = 3.9\text{ V}$	3.55	3.60	3.65	V
DC-DC EFFICIENCY						
η_{Power}	Power Efficiency, Low-Power Auto Mode, $V_{IN} = 3.7\text{ V}$	$V_{OUT} = 3.1\text{ V}$, $I_{LOAD} = 250\text{ mA}$		95		%
		$V_{OUT} = 1.8\text{ V}$, $I_{LOAD} = 250\text{ mA}$		90		
		$V_{OUT} = 0.5\text{ V}$, $I_{LOAD} = 10\text{ mA}$		65		
OUTPUT REGULATION						
V_{OUT_RLine}	V_{OUT} Line Regulation	$3.1 \leq V_{IN} \leq 3.7$		± 5		mV
V_{OUT_RLoad}	V_{OUT} Load Regulation	$20\text{ mA} \leq I_{OUT} \leq 800\text{ mA}$		± 25		mV
V_{OUT_Ripple}	V_{OUT} Ripple	PFM Mode, $V_{IN} = 3.7\text{ V}$, $I_{OUT} < 100\text{ mA}$		11		mV
		PWM Mode, $V_{IN} = 3.7\text{ V}$		4		
TIMING						
t_{SS}	Startup Time (Note 9)	$V_{IN} = 3.7\text{ V}$, V_{OUT} from 0 V to 3.1 V , $C_{OUT} = 3 \times 4.7\ \mu\text{F}$, 10 V , X5R		50	60	μs
t_{DC-DC_TR}	V_{CON} Step Response Rise Time (Note 9)	From V_{CON} to $95\% V_{OUT}$, $\Delta V_{OUT} \leq 2.7\text{ V}$ ($0.7\text{ V} - 3.4\text{ V}$), $R_{LOAD} = 5\ \Omega$, $C_{OUT} = 14\ \mu\text{F}$		6.0	7.3	μs
t_{DC-DC_TF}	V_{CON} Step Response Fall Time (Note 9)	From V_{CON} to $5\% V_{OUT}$, $\Delta V_{OUT} \leq 2.7\text{ V}$ ($3.4\text{ V} - 0.7\text{ V}$), $R_{LOAD} = 200\ \Omega$, $C_{OUT} = 14\ \mu\text{F}$		6.8	7.6	μs
t_{DC-DC_CL}	Maximum Allowed Time for Consecutive Current Limit (Note 10)	$V_{OUT} < 1\text{ V}$		1500		μs
t_{DCDC_CLR}	Consecutive Current Limit Recovery Time (Note 10)			4800		μs

6. Input voltages nominally exceeding the lesser of $V_{IN}/2.5$ or 1.6 V force 100% duty cycle.
7. Dropout depends on LDO and DC-DC PFET $R_{DS(ON)}$ and inductor DCR.
8. The current limit is the peak (maximum) current.
9. Guaranteed by design. Maximum values are based on simulation results with 50% C_{OUT} derating; not tested in production. Voltage transient only. Assumes $C_{OUT} = 3 \times 4.7\ \mu\text{F}$ ($1 \times 4.7\ \mu\text{F}$ for regulator and $2 \times 4.7\ \mu\text{F}$ for PA decoupling capacitors).
10. Protects part under short-circuit conditions

Product parametric performance is indicated in the Electrical Characteristics for the listed test conditions, unless otherwise noted. Product performance may not be indicated by the Electrical Characteristics if operated under different conditions.

Typical Characteristics

Unless otherwise noted, $V_{IN} = EN = 3.7\text{ V}$, $L = 1.0\ \mu\text{H}$, $C_{IN} = 10\ \mu\text{F}$, $C_{OUT} = 3 \times 4.7\ \mu\text{F}$, and $T_A = +25^\circ\text{C}$.

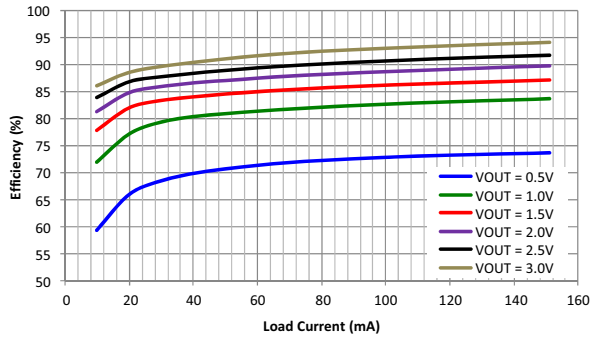

Figure 5. Efficiency vs. Load Current and Output Voltage, $V_{IN} = 3.8\text{ V}$, $I_{OUT} = 10\text{ mA to }150\text{ mA}$

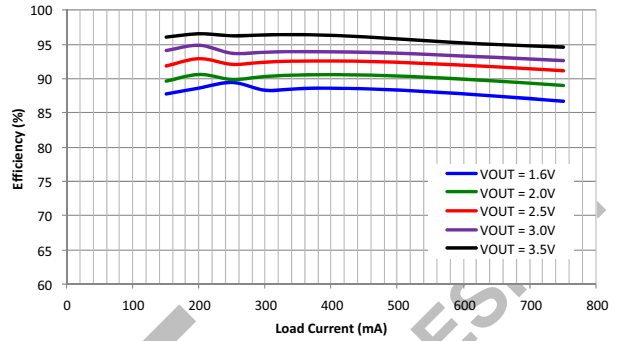

Figure 6. Efficiency vs. Load Current and Output Voltage, $V_{IN} = 3.8\text{ V}$

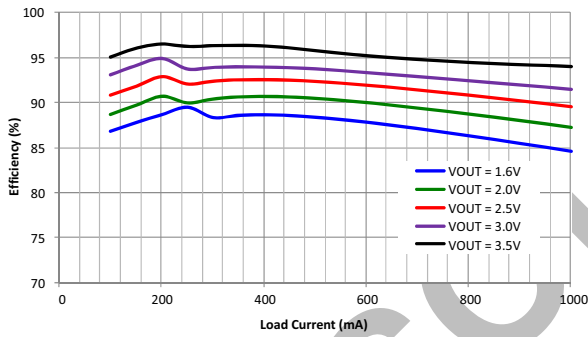

Figure 7. Efficiency vs. Load Current and Output Voltage, $V_{IN} = 3.8\text{ V}$, $I_{OUT} = 100\text{ mA to }1\text{ A}$

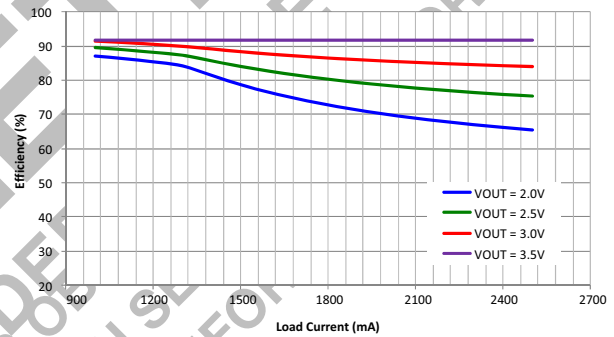

Figure 8. Efficiency vs. Load Current and Output Voltage, $V_{IN} = 3.8\text{ V}$, $I_{OUT} = 1\text{ A to }2.5\text{ A}$

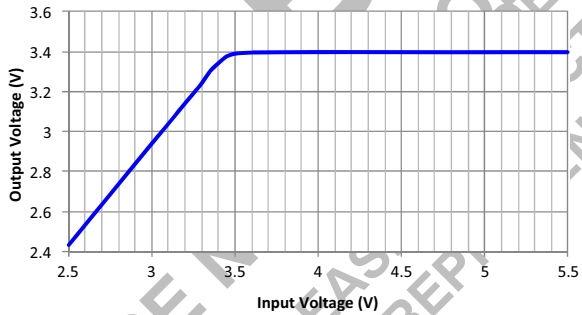

Figure 9. Output Voltage vs. Supply Voltage, $V_{OUT} = 3.4\text{ V}$, $I_{OUT} = 1.5\text{ A}$, $V_{IN} = 4.3\text{ V to Dropout}$

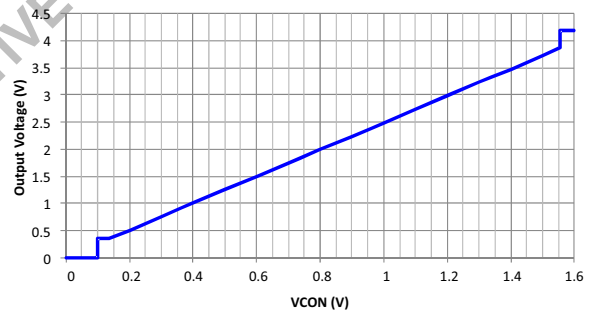

Figure 10. Output Voltage vs. V_{CON} Voltage, $V_{IN} = 4.2\text{ V}$, $R_{LOAD} = 6.8\ \Omega$, $0.1\text{ V} < V_{CON} < 1.6\text{ V}$

Typical Characteristics

Unless otherwise noted, $V_{IN} = EN = 3.7\text{ V}$, $L = 1.0\ \mu\text{H}$, $C_{IN} = 10\ \mu\text{F}$, $C_{OUT} = 3 \times 4.7\ \mu\text{F}$, and $T_A = +25^\circ\text{C}$.

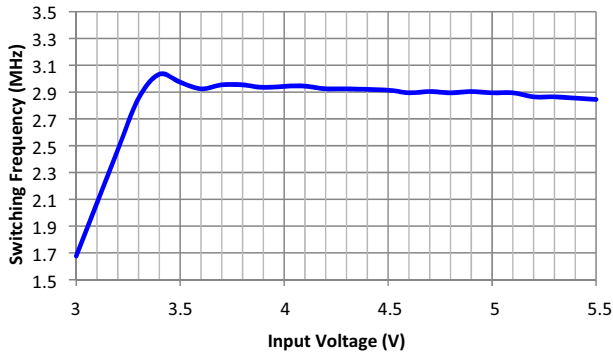

Figure 11. Center-Switching Frequency vs. Supply Voltage, $V_{OUT} = 2.5\text{ V}$, $I_{OUT} = 700\text{ mA}$

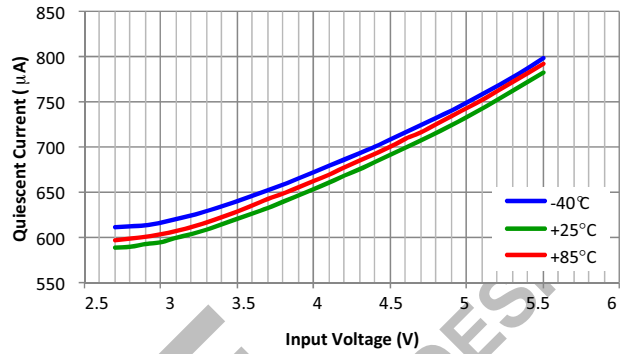

Figure 12. Quiescent Current (PFM) vs. Supply Voltage, $V_{OUT} = 1\text{ V}$, $2.7\text{ V} < V_{IN} < 5.5\text{ V}$ (No Load)

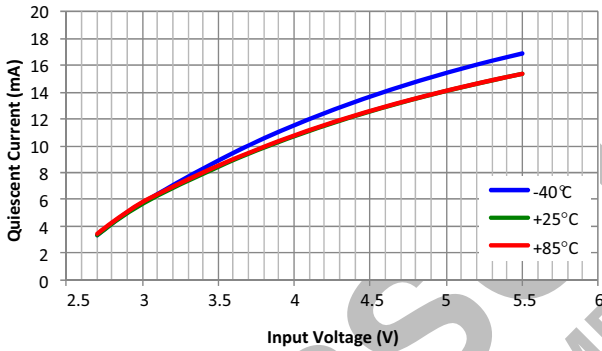

Figure 13. Quiescent Current (PWM) vs. Supply Voltage, $V_{OUT} = 2.5\text{ V}$, $2.7\text{ V} < V_{IN} < 5.5\text{ V}$ (No Load)

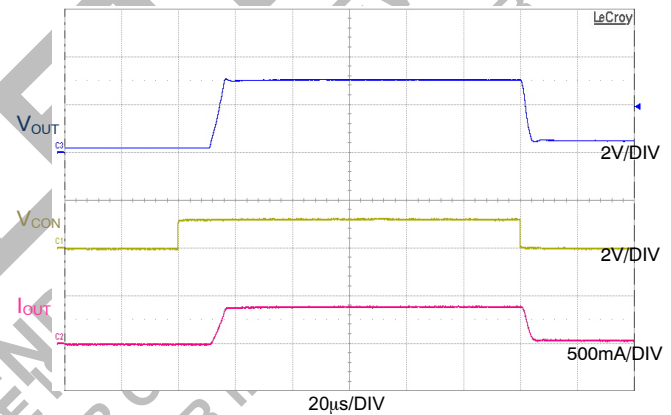

Figure 14. V_{CON} Transient (3 G/4 G), $V_{OUT} = 0\text{ V}$ to 3 V , $R_{LOAD} = 6.8\ \Omega$, $V_{IN} = 3.8\text{ V}$, 100 ns Edge

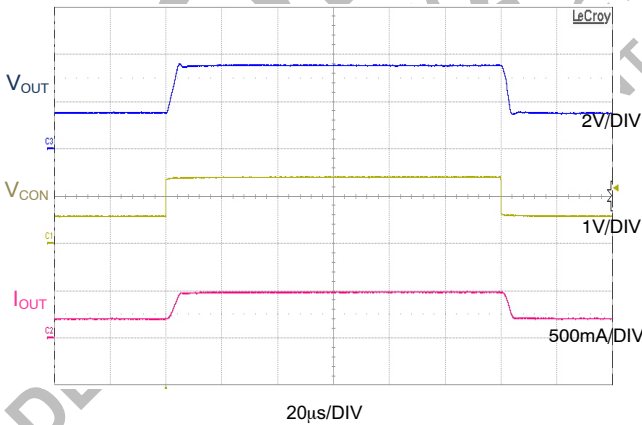

Figure 15. V_{CON} Transient (PFM to PWM), $V_{OUT} = 1.4\text{ V}$ to 3.4 V , $R_{LOAD} = 6.8\ \Omega$, $V_{IN} = 3.8\text{ V}$, 100 ns Edge

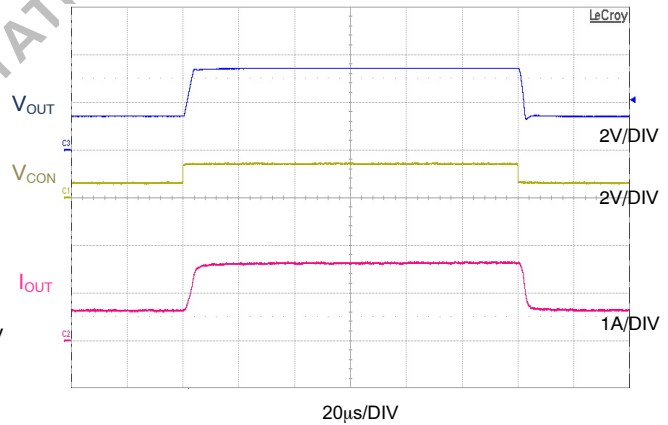

Figure 16. V_{CON} Transient (PWM), $V_{OUT} = 1.4\text{ V}$ to 3.4 V , $R_{LOAD} = 1.9\ \Omega$, $V_{IN} = 4.2\text{ V}$, 100 ns Edge

Typical Characteristics

Unless otherwise noted, $V_{IN} = EN = 3.7\text{ V}$, $L = 1.0\ \mu\text{H}$, $C_{IN} = 10\ \mu\text{F}$, $C_{OUT} = 3 \times 4.7\ \mu\text{F}$, and $T_A = +25^\circ\text{C}$.

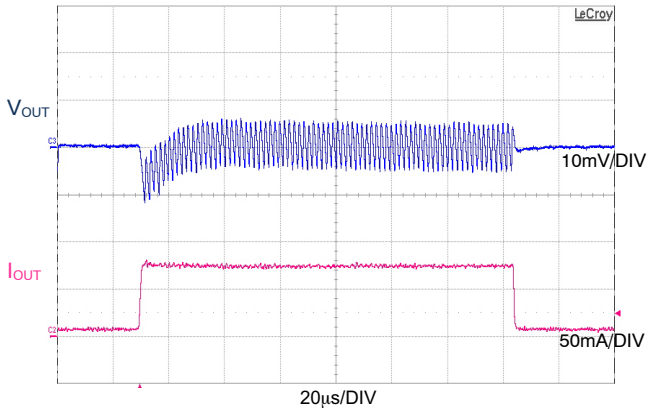

Figure 17. Load Transient in PFM Mode, $V_{IN} = 3.6\text{ V}$, $V_{OUT} = 1\text{ V}$, $I_{OUT} = 0\text{ mA}$ to 60 mA , $1\ \mu\text{s}$ Edge

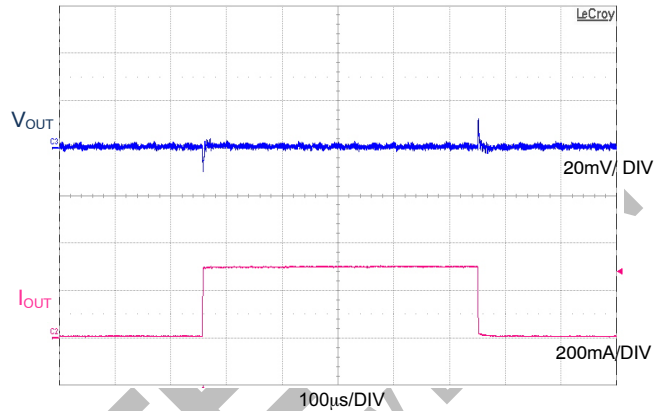

Figure 18. Load Transient in PWM Mode, $V_{IN} = 3.8\text{ V}$, $V_{OUT} = 2.5\text{ V}$, $I_{OUT} = 0\text{ mA}$ to 300 mA , $10\ \mu\text{s}$ Edge

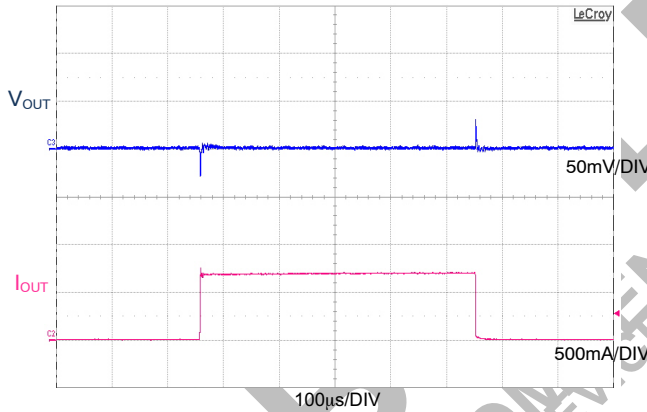

Figure 19. Load Transient in PWM Mode, $V_{IN} = 3.8\text{ V}$, $V_{OUT} = 3.0\text{ V}$, $I_{OUT} = 0\text{ mA}$ to 700 mA , $10\ \mu\text{s}$ Edge

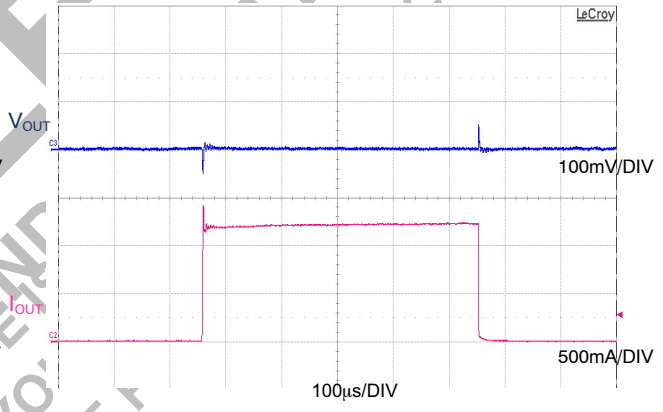

Figure 20. Load Transient in PWM Mode, $V_{IN} = 4.2\text{ V}$, $V_{OUT} = 3.0\text{ V}$, $I_{OUT} = 0\text{ mA}$ to 1.2 A , $10\ \mu\text{s}$ Edge

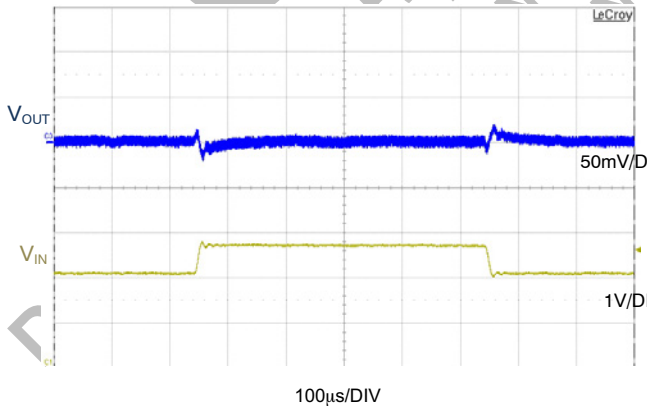

Figure 21. Line Transient, $V_{IN} = 3.6\text{ V}$ to 4.2 V , $V_{OUT} = 1.0\text{ V}$, $6.8\ \Omega$ Load, $10\ \mu\text{s}$ Edge

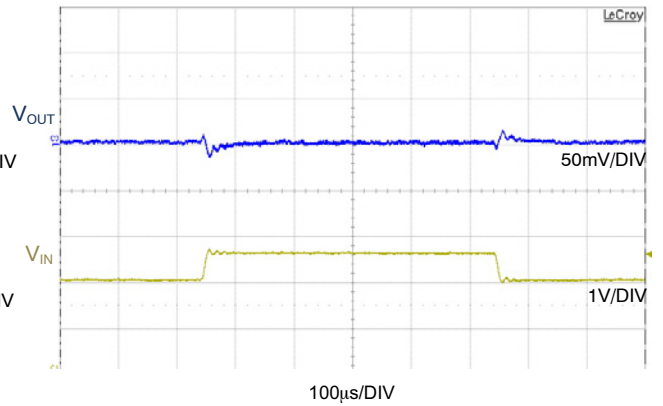

Figure 22. Line Transient, $V_{IN} = 3.6\text{ V}$ to 4.2 V , $V_{OUT} = 2.5\text{ V}$, $6.8\ \Omega$ Load, $10\ \mu\text{s}$ Edge

Typical Characteristics

Unless otherwise noted, $V_{IN} = EN = 3.7\text{ V}$, $L = 1.0\ \mu\text{H}$, $C_{IN} = 10\ \mu\text{F}$, $C_{OUT} = 3 \times 4.7\ \mu\text{F}$, and $T_A = +25^\circ\text{C}$.

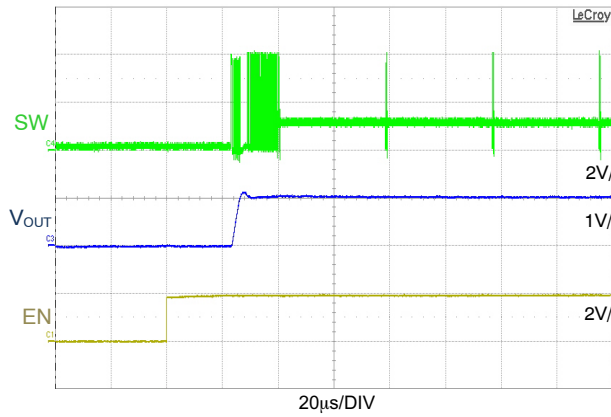

Figure 23. Startup in PFM Mode, $V_{IN} = 3.8\text{ V}$, $V_{OUT} = 1.0\text{ V}$, No Load, EN = Low to High

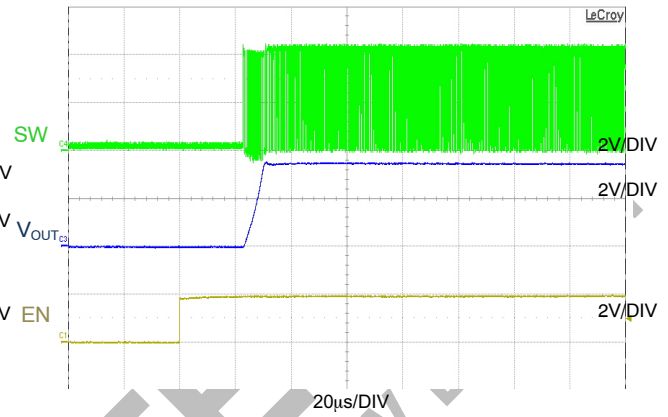

Figure 24. Startup in PWM Mode, $V_{IN} = 4.2\text{ V}$, $V_{OUT} = 3.4\text{ V}$, No Load, EN = Low to High

OBSOLETE

DEVICE NOT RECOMMENDED FOR NEW DESIGN
THIS DEVICE IS OBSOLETE FOR NEW DESIGN
PLEASE CONTACT YOUR ON SEMICONDUCTOR REPRESENTATIVE FOR INFORMATION

Operating Description

The FAN5909 is a high-efficiency, synchronous, step-down converter (DC-DC) with LDO-assist function.

The DC-DC converter operates with current-mode control and supports a wide range of load currents. High-current applications up to a 2.5 A DC output, such as mandated by GSM/EDGE applications, are allowed. Performance degradation due to spurs is removed by spreading the ripple energy through clock dither. A regulated Bypass Mode continues to regulate the output to the desired voltage as V_{IN} approaches V_{OUT} . The LDO offers a dropout voltage of approximately 100 mV under a 2 A load current.

The output voltage V_{OUT} is regulated to 2.5 times the input control voltage, V_{CON} , set by an external DAC. The FAN5909 operates in either PWM or PFM Mode, depending on the output voltage and load current.

In Pulse Width Modulation (PWM) Mode, regulation begins with on-state. A P-channel transistor is turned on and the inductor current is ramped up until the off-state begins. In the off-state, the P-channel is switched off and an N-channel transistor is turned on. The inductor current decreases to maintain an average value equal to the DC load current. The inductor current is continuously monitored. A current sense flags when the P-channel transistor current exceeds the current limit and the switcher is turned back to off-state to decrease the inductor current and prevent magnetic saturation. The current sense flags when the N-channel transistor current exceeds the current limit and redirects discharging current through the inductor back to the battery.

In Pulse Frequency Modulation (PFM) Mode, the FAN5909 operates in a constant on-time mode at low load currents. During on-state, the P-channel is turned on for a specified time before switching to off-state. In off-state, the N-channel switch is enabled until inductor current decreases to 0 A. The switcher enters three-state until a new regulation cycle starts.

PFM operation is allowed only in Low-Power Mode (MODE=1) for output voltages nominally less than 1.5 V. At low load currents, PFM achieves higher efficiency than PWM. The trade-off for efficiency improvement, however, is larger output ripple. Some applications, such as audio, may not tolerate the higher ripple, especially at high output voltages.

Dynamic Output Voltage Transitions

FAN5909 has a complex voltage transition controller that realizes 6 μ s transition times with a large output capacitor and output voltage ranges.

The transition controller manages five transitions:

- ΔV_{OUT} positive step
- ΔV_{OUT} negative step
- ΔV_{OUT} transition to or from 100% duty cycle
- ΔV_{OUT} transition at startup

In all cases, it is recommended that sharp V_{CON} transitions be applied, letting the transition controller optimize the output voltage slew rate.

ΔV_{OUT} Positive Step

After a V_{CON} positive step, the FAN5909 enters Current-Limit Mode, where V_{OUT} ramps with a constant slew rate dictated by the output capacitor and the current limit.

ΔV_{OUT} Negative Step

After a V_{CON} negative step, the FAN5909 enters Current Limit Mode where V_{OUT} is reduced with a constant slew rate dictated by the output capacitor and the current limit.

V_{OUT} Transition to or from Forced Bypass

The DC-DC is forced into 100% duty cycle for V_{CON} nominally greater than 1.6 V. This allows the output to be connected to the supply through both the low-resistance DC-DC and the LDO PFETs.

V_{OUT} Transition at Startup

At startup, after the EN rising edge is detected, the system requires 25 μ s for all internal voltage references and amplifiers to start before enabling the DC-DC converter function.

MODE Pin

The MODE pin enable Forced PWM Mode or Auto PFM / PWM Mode. When the MODE pin is toggled HIGH (logic 1), the FAN5909 operates in PFM for $V_{OUT} \leq 1.5$ V under light-load conditions and PWM for heavy-load conditions. If the MODE pin is set LOW (logic = 0), it operates in Forced PWM Mode.

Auto PFM / PWM Mode (MODE = 1)

Auto PFM/PWM Mode is appropriate for 3 G/3.5 G and 4 G applications.

Forced PWM Mode (MODE = 0)

Forced PWM Mode is appropriate for applications that demand minimal ripple over the entire output voltage range.

DC-DC – LDO-Assist

The LDO-assist function maintains output regulation when V_{IN} approaches V_{OUT} , enables fast transition times under heavy loads, and minimizes PCB space by enabling a smaller inductor to be employed by using the LDO to provide a portion of the necessary load current.

The LDO-assist function limits the maximum current that the DC-DC may supply by shunting current away from the DC-DC under heavy loads and high duty cycles. In addition, the LDO-assist enables a seamless transition into 100% duty cycle, ensuring both low output ripple and constant output regulation. Since the LDO-assist function limits the maximum current supplied by the DC-DC, PCB area is minimized by enabling a lower current capable, and thus smaller form factor, inductor to be used.

FAN5909

DC-DC – Sleep Mode

The Sleep Mode minimizing current while enabling rapid return to regulation. Sleep Mode is entered when V_{CON} is held below 70 mV for at least 40 μ s. In this mode, current consumption is reduced to under 50 μ A. Sleep Mode is exited after \sim 12 μ s when V_{CON} is set above 125 mV.

Application Information

Figure 26 illustrates the FAN5909 in a GSM / EDGE / WCDMA transmitter configuration, driving multiple GSM / EDGE and 3 G/3.5 G and 4 G PAs. Figure 27 presents a timing diagram designed to meet GSM specifications.

DC Output Voltage

The output voltage is determined by V_{CON} provided by an external DAC or voltage reference:

$$V_{OUT} = 2.5 \times V_{CON} \quad (\text{eq. 1})$$

The FAN5909 provides regulated V_{OUT} only if V_{CON} falls within the typical range from 0.16 V to 1.44 V. This allows V_{OUT} to be adjusted between 0.4 V and 3.6 V. If V_{CON} is less than 0.16 V, V_{OUT} is clamped to 0.40 V. In Auto PFM/PWM Mode, the FAN5909 automatically switches between PFM and PWM. In Forced PWM Mode (MODE = 0), the FAN5909 automatically switches into PWM Mode.

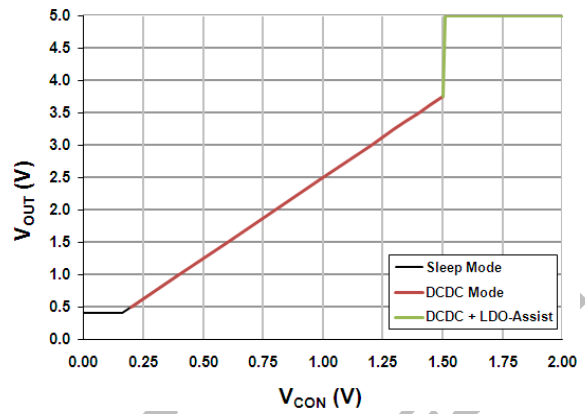

Figure 25. Output Voltage vs. Control Voltage

The FAN5909 is designed to support voltage transients of 6 μ s when configured for GSM/EDGE applications (MODE=0) and driving a load capacitance of approximately 14 μ F. Figure 28 shows a timing diagram for WCDMA applications.

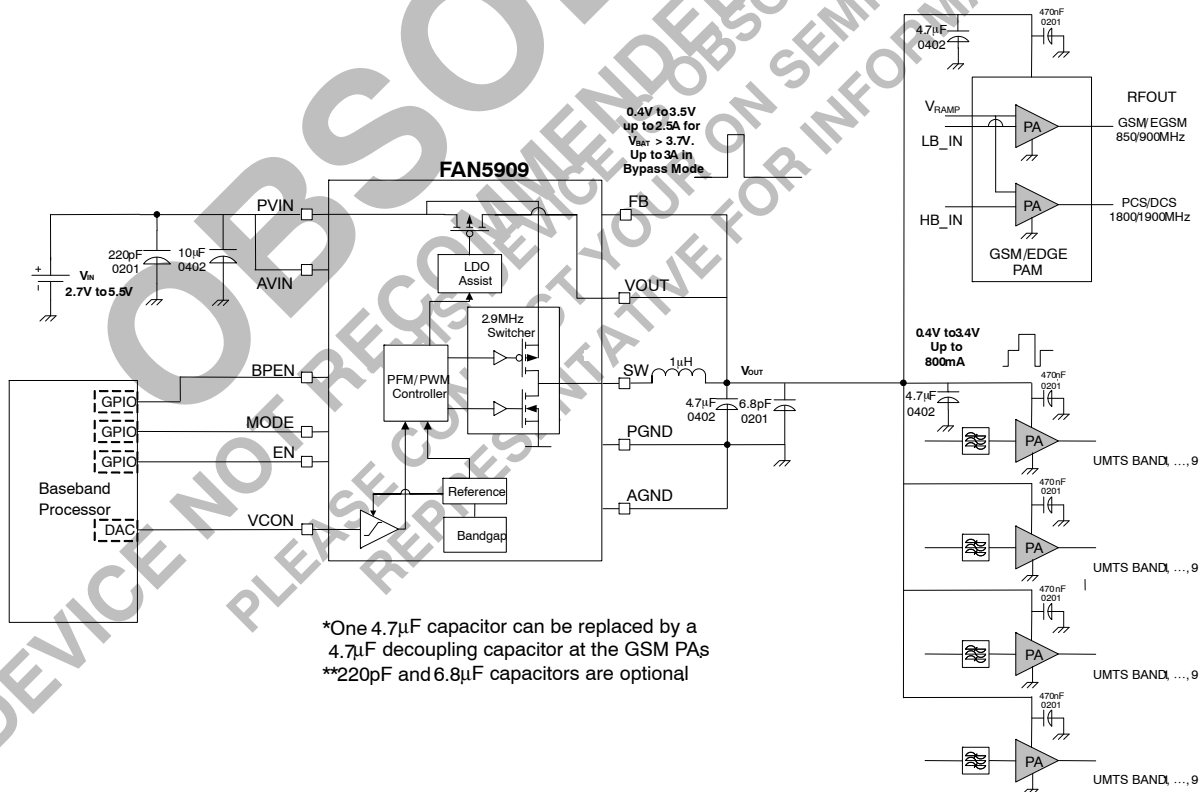

Figure 26. Typical Application Diagram with GSM/EDGE/WCDMA Transmitters

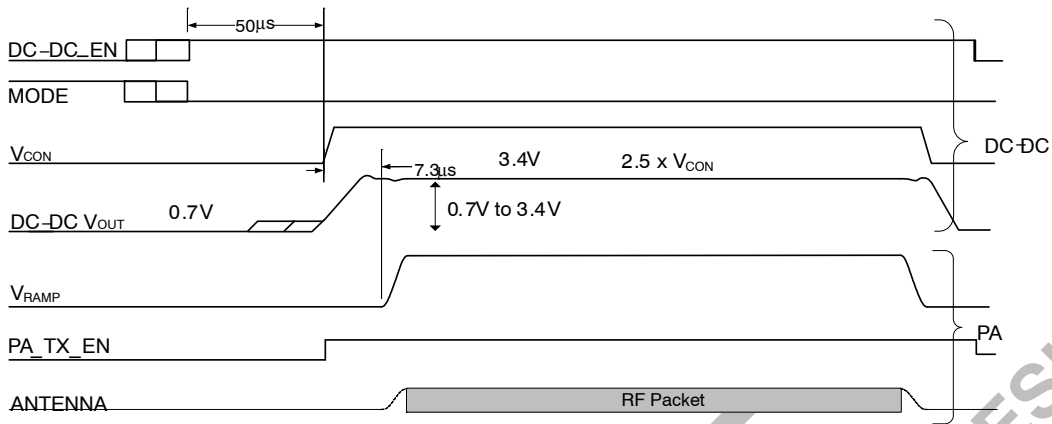

Figure 27. Timing Diagram for GSM/EDGE Transmitters



Figure 28. Timing Diagram for WCDMA Transmitters

Inductor Selection

The FAN5909 operates at 2.9 MHz switching frequency, allowing 1.0 µH or 1.5 µH inductors to be used in designs. For applications requiring the smallest possible PCB area, use a 1.0 µH 2012 inductor or a 1.0 µH 2016 inductor for optimum efficiency performance.

Table 5. RECOMMENDED INDUCTORS

Inductor	Description
L	1.0 µH ±20%, 2.1 A, 2012 Case Size Cynotec: PSK20121T-1R0MS-63
	1.0 µH ±20%, 2.2 A, 2016 Case Size Tokko: DFE201610R-H-1R0M

Capacitor Selection

The minimum required output capacitor C_{OUT} should be one (1) 4.7 µF, 6.3 V, X5R with an ESR of 10 mΩ or lower and an ESL of 0.3 nH or lower in parallel after inductor L1. Larger case sizes result in increased loop parasitic inductance and higher noise. One 4.7 µF capacitor should be used as a decoupling capacitor at the GSM/EDGE PA V_{CC} pin and another 4.7 µF capacitor should be placed at V_{CC} pin of the 3 G/4 G PA.

A 6.8 pF capacitor may be added in parallel with C_{OUT} to reduce the capacitor’s parasitic inductance.

Table 6. RECOMMENDED CAPACITOR VALUES

Capacitor	Description
C_{IN}	10 µF, ±20%, X5R, 6.3 V, 0402 (1005 metric) TDK C1005X5R0J106M
C_{OUT}	4.7 µF, ±20%, X5R, 6.3 V, 0402 (1005 metric) TDK C1005X5R0J475K

PCB Layout and Component Placement

- The key point in the placement is the power ground (PGND) connection shared between the FAN5909, C_{IN} , and C_{OUT} . This minimizes the parasitic inductance of the switching loop paths.
- Place the inductor away from the feedback pins to prevent unpredictable loop behavior.
- Ensure the traces are wide enough to handle the maximum current value, especially in Bypass Mode.
- Ensure the vias are able to handle the current density. Use filled vias if available.

FAN5909

PACKAGE DIMENSIONS

WLCSP16 1.615x1.615x0.586
CASE 567SD
ISSUE O

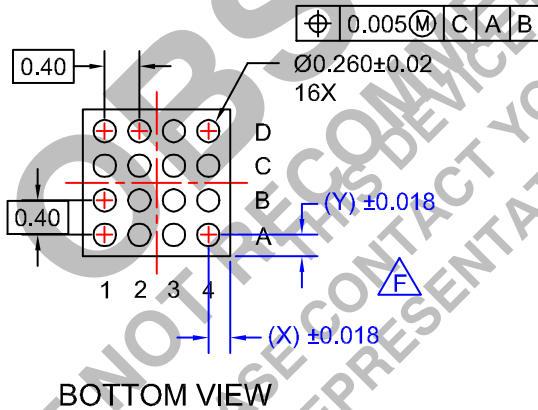
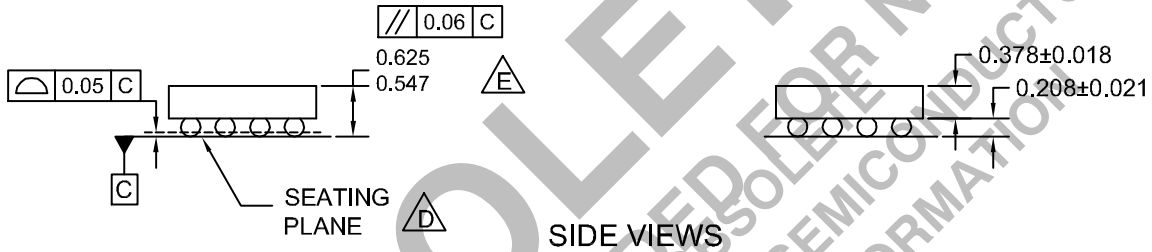
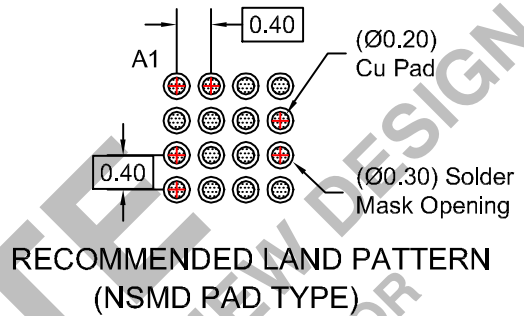
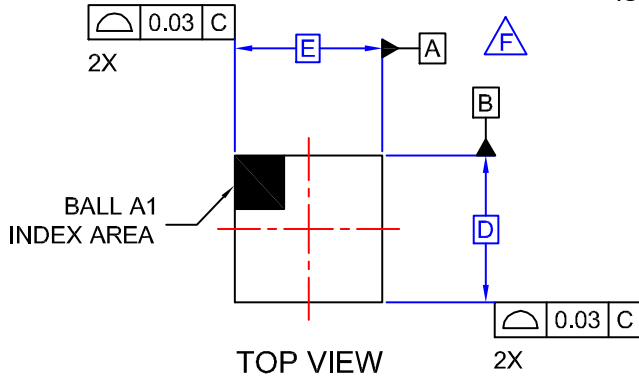

NOTES:

- A. NO JEDEC REGISTRATION APPLIES.
- B. DIMENSIONS ARE IN MILLIMETERS.
- C. DIMENSIONS AND TOLERANCE PER ASME Y14.5M, 1994.
- DATUM C IS DEFINED BY THE SPHERICAL CROWNS OF THE BALLS.
- PACKAGE NOMINAL HEIGHT IS 586 MICRONS ±39 MICRONS (547-625 MICRONS).
- FOR DIMENSIONS D, E, X, AND Y SEE PRODUCT DATASHEET.

PRODUCT SPECIFIC DIMENSIONS

D	E	X	Y	Unit
1.615 ± 0.030	1.615 ± 0.030	0.2075	0.2075	mm

OBSOLETE
 DO NOT RECOMMENDED FOR NEW DESIGN
 THIS DEVICE IS OBSOLETE FOR NEW DESIGN
 PLEASE CONTACT YOUR ON SEMICONDUCTOR
 REPRESENTATIVE FOR INFORMATION

ON Semiconductor and  are trademarks of Semiconductor Components Industries, LLC dba ON Semiconductor or its subsidiaries in the United States and/or other countries. ON Semiconductor owns the rights to a number of patents, trademarks, copyrights, trade secrets, and other intellectual property. A listing of ON Semiconductor's product/patent coverage may be accessed at www.onsemi.com/site/pdf/Patent-Marking.pdf. ON Semiconductor reserves the right to make changes without further notice to any products herein. ON Semiconductor makes no warranty, representation or guarantee regarding the suitability of its products for any particular purpose, nor does ON Semiconductor assume any liability arising out of the application or use of any product or circuit, and specifically disclaims any and all liability, including without limitation special, consequential or incidental damages. Buyer is responsible for its products and applications using ON Semiconductor products, including compliance with all laws, regulations and safety requirements or standards, regardless of any support or applications information provided by ON Semiconductor. "Typical" parameters which may be provided in ON Semiconductor data sheets and/or specifications can and do vary in different applications and actual performance may vary over time. All operating parameters, including "Typicals" must be validated for each customer application by customer's technical experts. ON Semiconductor does not convey any license under its patent rights nor the rights of others. ON Semiconductor products are not designed, intended, or authorized for use as a critical component in life support systems or any FDA Class 3 medical devices or medical devices with a same or similar classification in a foreign jurisdiction or any devices intended for implantation in the human body. Should Buyer purchase or use ON Semiconductor products for any such unintended or unauthorized application, Buyer shall indemnify and hold ON Semiconductor and its officers, employees, subsidiaries, affiliates, and distributors harmless against all claims, costs, damages, and expenses, and reasonable attorney fees arising out of, directly or indirectly, any claim of personal injury or death associated with such unintended or unauthorized use, even if such claim alleges that ON Semiconductor was negligent regarding the design or manufacture of the part. ON Semiconductor is an Equal Opportunity/Affirmative Action Employer. This literature is subject to all applicable copyright laws and is not for resale in any manner.

PUBLICATION ORDERING INFORMATION

LITERATURE FULFILLMENT:

Literature Distribution Center for ON Semiconductor
 19521 E. 32nd Pkwy, Aurora, Colorado 80011 USA
Phone: 303-675-2175 or 800-344-3860 Toll Free USA/Canada
Fax: 303-675-2176 or 800-344-3867 Toll Free USA/Canada
Email: orderlit@onsemi.com

N. American Technical Support: 800-282-9855 Toll Free
 USA/Canada
Europe, Middle East and Africa Technical Support:
 Phone: 421 33 790 2910
Japan Customer Focus Center
 Phone: 81-3-5817-1050

ON Semiconductor Website: www.onsemi.com

Order Literature: <http://www.onsemi.com/orderlit>

For additional information, please contact your local
 Sales Representative