



Is Now Part of



ON Semiconductor®

To learn more about ON Semiconductor, please visit our website at
www.onsemi.com

Please note: As part of the Fairchild Semiconductor integration, some of the Fairchild orderable part numbers will need to change in order to meet ON Semiconductor's system requirements. Since the ON Semiconductor product management systems do not have the ability to manage part nomenclature that utilizes an underscore (_), the underscore (_) in the Fairchild part numbers will be changed to a dash (-). This document may contain device numbers with an underscore (_). Please check the ON Semiconductor website to verify the updated device numbers. The most current and up-to-date ordering information can be found at www.onsemi.com. Please email any questions regarding the system integration to Fairchild_questions@onsemi.com.

ON Semiconductor and the ON Semiconductor logo are trademarks of Semiconductor Components Industries, LLC dba ON Semiconductor or its subsidiaries in the United States and/or other countries. ON Semiconductor owns the rights to a number of patents, trademarks, copyrights, trade secrets, and other intellectual property. A listing of ON Semiconductor's product/patent coverage may be accessed at www.onsemi.com/site/pdf/Patent-Marking.pdf. ON Semiconductor reserves the right to make changes without further notice to any products herein. ON Semiconductor makes no warranty, representation or guarantee regarding the suitability of its products for any particular purpose, nor does ON Semiconductor assume any liability arising out of the application or use of any product or circuit, and specifically disclaims any and all liability, including without limitation special, consequential or incidental damages. Buyer is responsible for its products and applications using ON Semiconductor products, including compliance with all laws, regulations and safety requirements or standards, regardless of any support or applications information provided by ON Semiconductor. "Typical" parameters which may be provided in ON Semiconductor data sheets and/or specifications can and do vary in different applications and actual performance may vary over time. All operating parameters, including "Typicals" must be validated for each customer application by customer's technical experts. ON Semiconductor does not convey any license under its patent rights nor the rights of others. ON Semiconductor products are not designed, intended, or authorized for use as a critical component in life support systems or any FDA Class 3 medical devices or medical devices with a same or similar classification in a foreign jurisdiction or any devices intended for implantation in the human body. Should Buyer purchase or use ON Semiconductor products for any such unintended or unauthorized application, Buyer shall indemnify and hold ON Semiconductor and its officers, employees, subsidiaries, affiliates, and distributors harmless against all claims, costs, damages, and expenses, and reasonable attorney fees arising out of, directly or indirectly, any claim of personal injury or death associated with such unintended or unauthorized use, even if such claim alleges that ON Semiconductor was negligent regarding the design or manufacture of the part. ON Semiconductor is an Equal Opportunity/Affirmative Action Employer. This literature is subject to all applicable copyright laws and is not for resale in any manner.



FAN8831

Sinusoidal Piezoelectric Actuator Driver with Step-Up DC-DC Converter

Features

Step-Up DC-DC Converter

- Integrated Step-up Power Switch up to 36 V
- Wide Operating Voltage Range of 2.7 to 5.5 V
- Adjustable Step-up Output Voltage
- Adjustable Step-up Current Limit
- Zero Current Detector (ZCD)
- Internal Soft-Start
- Built-in Protection Circuit
 - Over Voltage Protection (OVP)
 - Thermal Shutdown (TSD)

Piezo Actuator Driver

- Integrated Full-Bridge Switches ($V_{DS}=75\text{ V}$)
- Digitally Implemented Sine Modulator

Package Information

- Small 4.0 mm × 4.0 mm MLP

Applications

- Piezo Actuator

Description

The FAN8831 is a single-chip piezoelectric actuator driver consisting of step-up DC-DC converter with integrated 36 V boost switch and a full-bridge output stage. The device is capable of driving a Piezo bi-directionally at 120 V peak-to-peak from a single 3 V lithium cell. The step-up DC-DC converter operates in Critical Conduction Mode (CRM) and is optimized to work in a coupled inductor configuration to provide output voltages in excess of 60 V. Over-voltage protection, over-current protection and thermal shutdown are all provided. An internal ready is used to enable the full-bridge gate driver when step-up DC-DC converter output voltage reaches the proper level with hysteresis.

The boost voltage is set using external resistors, and step-up current limit is programmable via the external resistor at OCP pin.

The output H-bridge features four integrated 75 V P and N-channel for sine wave drive of the Piezo actuator.

Ordering Information

Part Number	Operating Temperature Range	Package	Packing Method
FAN8831MPX	-40°C to +125°C	24-Lead, MLP	Tape & Reel

Application Diagram

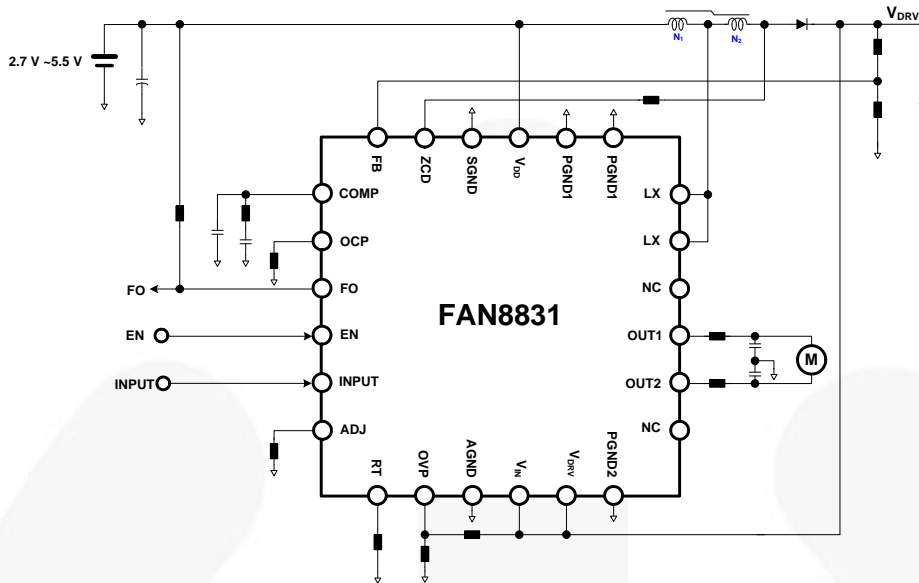

Figure 1. Typical Application Circuit for Piezo Actuator Driver

Internal Block Diagram

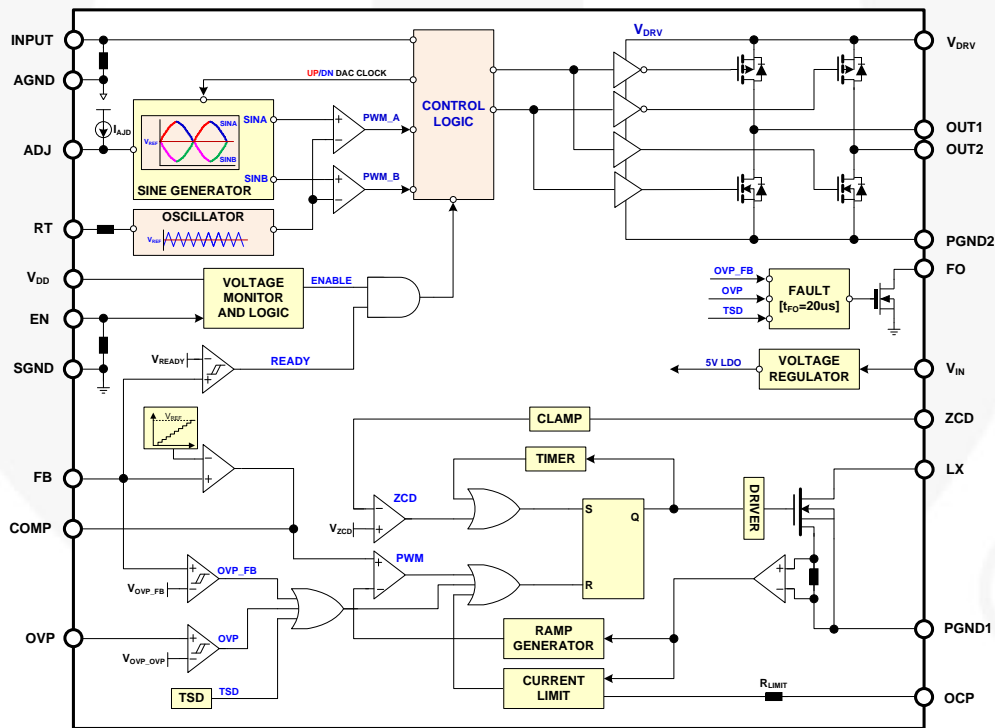

Figure 2. Functional Block Diagram

Pin Configuration

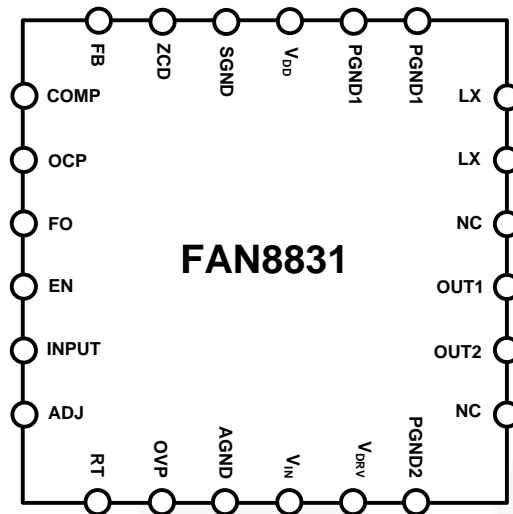

Figure 3. Pin Assignments

Pin Definitions

Pin #	Name	Description
1,2	PGND1	Power Ground 1. It is connected to the source of the step-up switch.
3	V _{DD}	Power supply of step-up DC-DC converter.
4	SGND	Signal Ground. The signal ground for step-up DC-DC converter circuitry.
5	ZCD	The input of the zero current detection.
6	FB	Step-up DC-DC converter output voltage feedback input.
7	COMP	Output of the transconductance error amplifier.
8	OCP	Sets Step-up DC-DC converter current limit.
9	FO	Fault Output.
10	EN	Enable pin to turn on and off the overall system. (Active Low Shutdown Mode).
11	INPUT	Logic input for sinusoidal waveform.
12	ADJ	Output voltage adjust control pin. Connect to internal current source to change output voltage using an external resistor. Connect a small capacitor (1 nF).
13	RT	Oscillator frequency control pin.
14	OVP	Voltage sense input of Step-up DC-DC converter for Over-Voltage Protection.
15	AGND	Analog Ground. The signal ground for full-bridge driver circuitry.
16	V _{IN}	Power supply of 5 V LDO.
17	V _{DRV}	Power supply of full-bridge driver.
18	PGND2	Power Ground 2. The power ground for full-bridge driver .
19	NC	Not Connected
20	OUT2	Output 2 for full-bridge driver.
21	OUT1	Output 1 for full-bridge driver.
22	NC	Not Connected
23, 24	L _x	Switch Node. This pin is connected to the inductor.

Absolute Maximum Ratings

Stresses exceeding the absolute maximum ratings may damage the device. The device may not function or be operable above the recommended operating conditions and stressing the parts to these levels is not recommended. In addition, extended exposure to stresses above the recommended operating conditions may affect device reliability. The absolute maximum ratings are stress ratings only.

Symbol	Parameter		Min.	Max.	Unit
V _{DRV}	DC Link Input Voltage Drain-Source Voltage of each MOSFET			75	V
V _{DD}	DC Supply Voltage for DC-DC Converter		-0.3	5.5	V
V _{IN,DCDC}	EN, INPUT, FB and COMP to SGND		-0.3	V _{DD} +0.3	V
V _{IN}	DC Supply Voltage for LDO		-0.3	75	V
V _{LX}	LX to PGND		-0.3	36	V
P _D	Power Dissipation ⁽²⁾	1S0P with thermal vias ⁽³⁾		0.98	W
		1S2P with thermal vias ⁽⁴⁾		2.9	
θ _{JA}	Thermal Resistance Junction-Air ⁽²⁾	1S0P with thermal vias ⁽³⁾		127	°C/W
		1S2P with thermal vias ⁽⁴⁾		43	
T _A	Operating Ambient Temperature Range		-40	125	°C
T _J	Operating Junction Temperature		-55	150	°C
T _{STG}	Storage Temperature Range		-55	150	°C
ESD	Electrostatic Discharge Capability	Human Body Model, JESD22-A114		2	KV
		Charged Device Model, JESD22-C101		500	V

Notes:

1. All voltage values, except differential voltages, are given with respect to SGND, AGND and PGND pin.
2. JEDEC standard: JESD51-2, JESD51-3. Mounted on 76.2x114.3x1.6mm PCB (FR-4 glass epoxy material).
3. 1S0P with thermal vias: one signal layer with zero power plane and thermal vias.
4. 1S2P with thermal vias: one signal layer with two power plane and thermal vias.

Recommended Operating Conditions

The Recommended Operating Conditions table defines the conditions for actual device operation. Recommended operating conditions are specified to ensure optimal performance to the datasheet specifications. Fairchild does not recommend exceeding them or designing to absolute maximum ratings.

Symbol	Parameter	Min.	Typ.	Max.	Unit
V _{DRV}	Supply Voltage for Full-Bridge Driver	30		60	V
V _{LX}	Boost Switch Voltage	10		30	V
V _{DD}	Operating Voltage for DC-DC Converter	2.7	3.0	3.3	V
V _{IN}	Operating Voltage for Voltage Regulator	10		60	V
R _{OCP}	Current Limit Control Resistor	7.0		150	kΩ

Electrical Characteristics

$V_{DD}=3.0\text{ V}$, $V_{IN}=15.0\text{ V}$, $V_{DRV}=60\text{ V}$, $R_T=70\text{ K}\Omega$ and $T_A=-40^\circ\text{C}$ to $+125^\circ\text{C}$. Typical values $T_A=25^\circ\text{C}$, unless otherwise specified.

Symbol	Parameter	Conditions	Min.	Typ.	Max.	Unit
Power Supply Section						
$I_{Q,DD}$	Quiescent Current for V_{DD} ⁽⁵⁾	$V_{EN}=V_{COMP}=V_{DD}$, $V_{FB}=1.0\text{ V}$ Device not switching		700	1200	μA
$I_{Q,IN}$	Quiescent Current for V_{IN}			300	500	μA
$I_{Q,DRV}$	Quiescent Current for V_{DRV}			200	300	μA
$I_{SD,DD}$	Shutdown Current for V_{DD}	$V_{EN}=0\text{ V}$, $V_{DD}=V_{IN}=V_{DRV}=3\text{ V}$			1	μA
$I_{SD,IN}$	Shutdown Current for V_{IN}				1	μA
$I_{SD,DRV}$	Shutdown Current for V_{DRV}			5	10	μA
$V_{DDSTART}$	Start Threshold Voltage		2.6	2.7	2.8	V
$V_{DDUVHYS}$	V_{DD} UVLO Hysteresis Voltage		0.1	0.2	0.3	V
Error Amplifier Section						
V_{FB}	Feedback Reference Voltage	$T_A=25^\circ\text{C}$	0.99	1.0	1.01	V
I_{FB}	FB pin Bias Current	$V_{FB}=0\text{ V} \sim 2\text{ V}$			1	μA
ΔV_{FB1}	Feedback Voltage Line Regulation ⁽⁶⁾	$2.7\text{ V} < V_{DD} < 5\text{ V}$		0.5	1.5	%/V
G_m	Transconductance	$T_A=25^\circ\text{C}$		800		μmho
Zero Current Detect Section						
V_{ZCD}	Input Voltage Threshold ⁽⁷⁾		1.65	1.83	2.00	V
V_{CLAMPH}	Input High Clamp Voltage	$I_{DET}=2.3\text{ mA}$	3.0	3.5	4.0	V
V_{CLAMPL}	Input Low Clamp Voltage	$I_{DET}=-2.3\text{ mA}$	-0.30	0.12	0.50	V
$I_{ZCD,SR}$	Source Current Capability				-2.3	mA
$I_{ZCD,SK}$	Sink Current Capability				2.3	mA
$t_{ZCD,D}$	Delay From ZCD to Output Turn-On ⁽⁷⁾			50	200	ns
Maximum On-Time Section						
$t_{ON,MAX}$	Maximum On-Time		15	25	35	μs
Restart / Maximum Switching Frequency Limit Section						
t_{RST}	Restart Timer		15	25	35	μs
f_{MAX}	Maximum Switching Frequency ⁽⁷⁾			900	1000	KHz
Soft-Start Timer Section						
t_{SS}	Internal Soft-Start		16	28	40	ms
Current Limit Comparator Section						
I_{OCP}	OCP Trip Current	$R_{OCP}=3.3\text{ K}\Omega$, $V_{DD}=3.3\text{ V}$	1.85	2.00	2.15	A
		$R_{OCP}=22\text{ K}\Omega$, $V_{DD}=3.3\text{ V}$	0.9	1.0	1.1	A
t_{CS_BLANK}	Comparator Leading-Edge Blanking Time ⁽⁷⁾		80	130	180	ns

Notes:

5. This is the V_{DD} current consumed when active but not switching. Does not include gate-drive current

$$\frac{\Delta V_{OUT}}{\Delta V_{IN}} \times \frac{1}{V_{OUT}}$$

6. The line regulation is calculated based on

7. This parameter, although guaranteed by design, is not tested in production.

Electrical Characteristics

$V_{DD}=3.0\text{ V}$, $V_{IN}=15.0\text{ V}$, $V_{DRV}=60\text{ V}$, $R_T=70\text{ K}\Omega$ and $T_A=-40^\circ\text{C}$ to $+125^\circ\text{C}$. Typical values $T_A=25^\circ\text{C}$, unless otherwise specified.

Symbol	Parameter	Conditions	Min.	Typ.	Max.	Unit
Step-Up Switch Section						
$R_{DS(on)}$	N-Channel On Resistance	$V_{DD}=3.3\text{ V}$, $T_A=25^\circ\text{C}$		0.2	0.5	Ω
I_{LK_LX}	LX Leakage Current	$V_{LX}=36\text{ V}$			1.0	μA
Oscillator Section						
f_{OSC}	Operating Frequency	$R_T=58\text{ K}\Omega$	40	50	60	KHz
		$R_T=121\text{ K}\Omega$	20	25	30	KHz
Logic (EN and INPUT) Section						
V_{INPUT+}	INPUT Logic High Threshold Voltage		1.34			V
V_{INPUT-}	INPUT Logic Low Threshold Voltage				0.5	V
I_{INPUT-}	Input Low Current for INPUT and EN	$V_{EN}=0\text{ V}$			1	μA
I_{INPUT+}	Input High Current for INPUT and EN	$V_{EN}=V_{DD}$	8	12	16	μA
R_{INPUT}	Input Logic Pull-Down Resistance	$V_{EN}=V_{INPUT}=3\text{ V}$		250	375	$\text{K}\Omega$
f_{INPUT}	Input Logic Operating Frequency ⁽⁸⁾		20		1000	Hz
Full-Bridge Switch Section						
$R_{DS,ONP}$	Output Upper-Side On Resistance	$T_A=25^\circ\text{C}$		3.0	5.0	Ω
$R_{DS,ONN}$	Output Low-Side On Resistance	$T_A=25^\circ\text{C}$		3.0	5.0	Ω
Output Control Section						
$V_{ADJ,MAX}$	Analog Output Control Maximum Voltage ⁽⁸⁾	$V_{DRV}=100\%$ of Target		1.0		V
$V_{ADJ,MIN}$	Analog Output Control Minimum Voltage ⁽⁸⁾			0.1		V
I_{ADJ+}	Internal Current Source for ADJ Pin	$T_A=25^\circ\text{C}$	9	10	11	μA
Protection (Ready, OVP and TSD)						
V_{READY}	Output Ready Threshold Voltage		0.75	0.80	0.85	V
HY_{READY}	Output Ready Hysteresis			0.2		V
V_{OVP_FB}	OVP Threshold Voltage at FB Pin		1.05	1.10	1.15	V
HY_{OVP_FB}	OVP Hysteresis Voltage at FB Pin			0.1		V
V_{OVP_OVP}	OVP Threshold Voltage at OVP Pin		1.10	1.15	1.20	V
HY_{OVP_OVP}	OVP Hysteresis Voltage at OVP Pin			0.15		V
T_{SD}	Thermal Shutdown Temperature ⁽⁸⁾			150		$^\circ\text{C}$
T_{HYS}	Hysteresis Temperature of TSD ⁽⁸⁾			50		$^\circ\text{C}$
T_{FO}	Fault Output Duration			20	30	μs
V_{FOL}	Fault Output Low Level Voltage	$R_{PU}=50\text{ K}\Omega$, $V_{PU}=3\text{ V}$		0.1	0.4	V

Note:

8. This parameter, although guaranteed by design, is not tested in production.

Typical Performance Characteristics

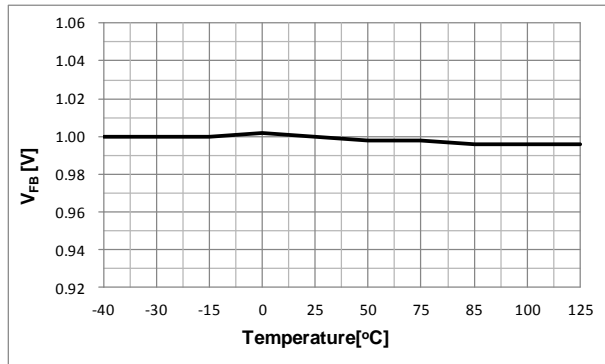

Figure 4. Reference Voltage vs. Temperature

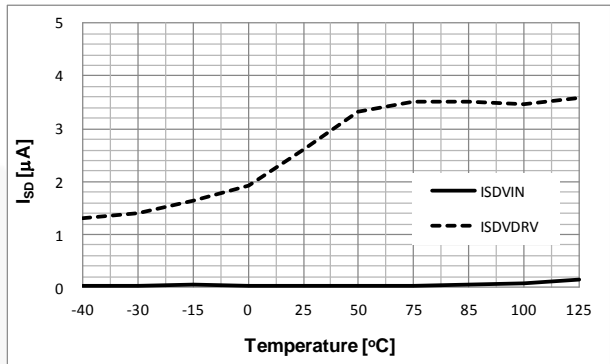

Figure 5. Shutdown Current for V_{DRV} & V_{IN} vs. Temperature

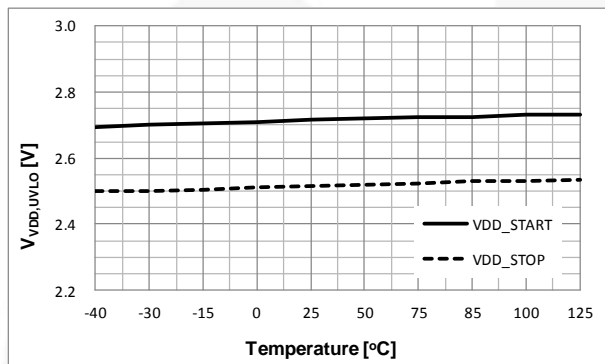

Figure 6. V_{DD} UVLO vs. Temperature

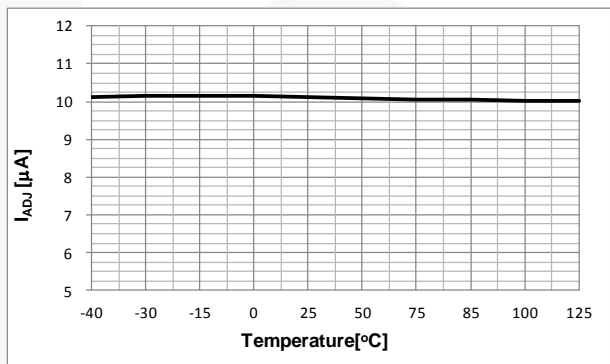

Figure 7. ADJ Current vs. Temperature

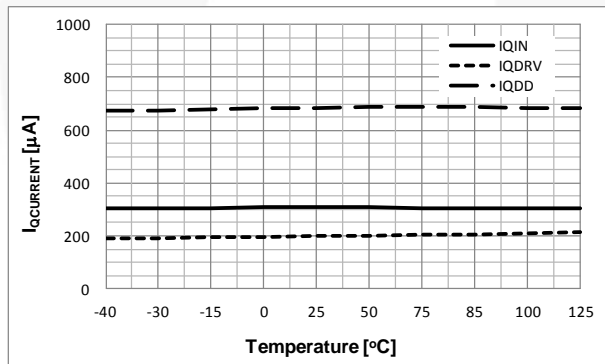

Figure 8. Quiescent Current for V_{DD}, V_{DRV}, & V_{IN} vs. Temperature

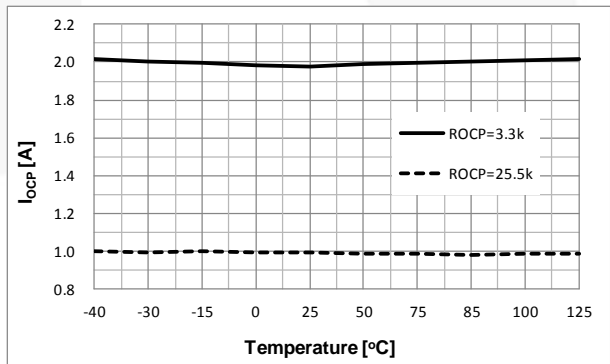

Figure 9. OCP Current vs. Temperature

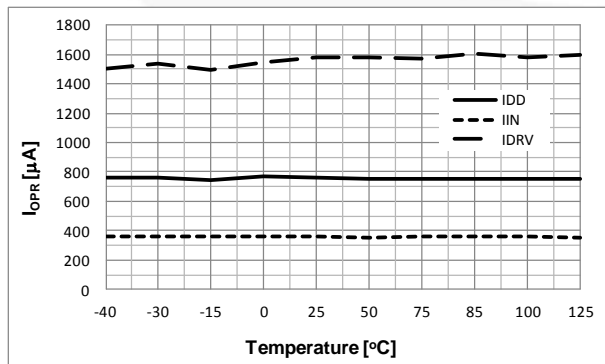

Figure 10. Operating Current for V_{DD}, V_{DRV}, & V_{IN} vs. Temperature

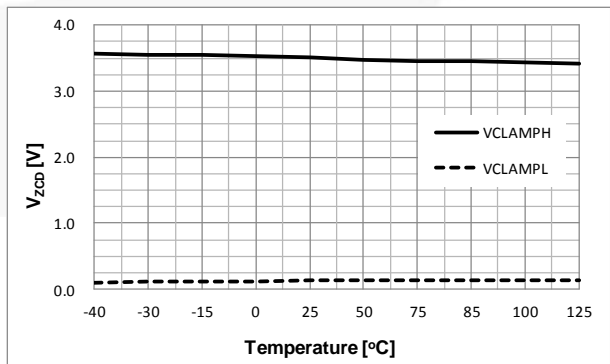

Figure 11. ZDC Clamp Voltage vs. Temperature

Typical Performance Characteristics

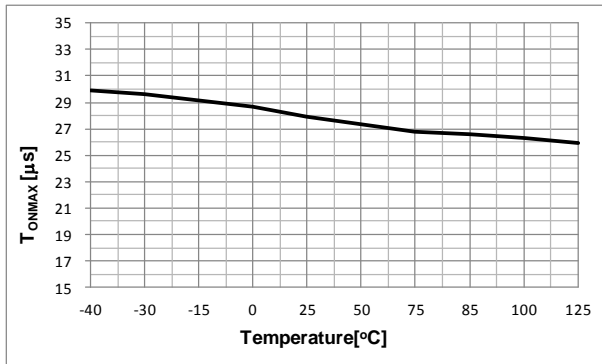

Figure 12. Maximum On-Time vs. Temperature

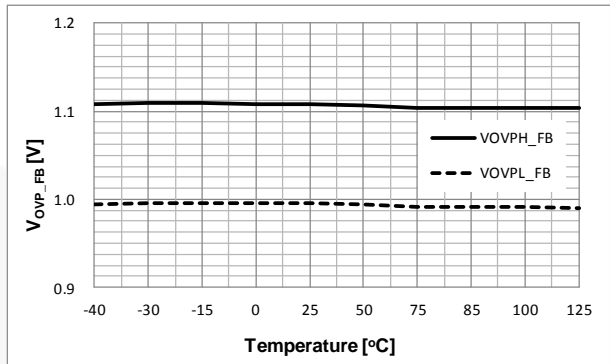

Figure 13. First OVP (FB) vs. Temperature

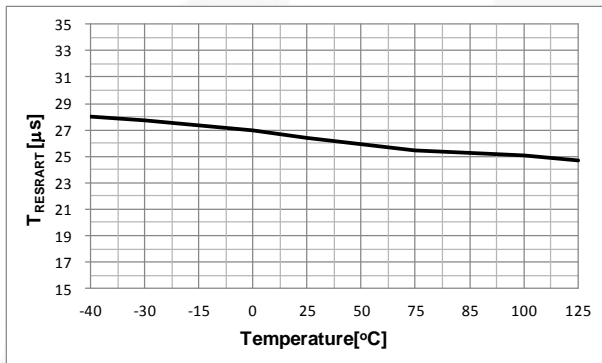

Figure 14. Restart-Time vs. Temperature

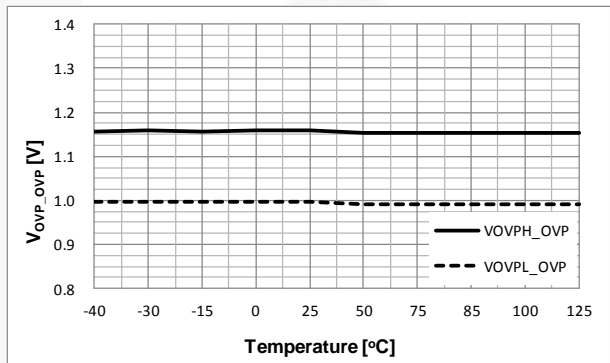

Figure 15. Second (OVP) vs. Temperature

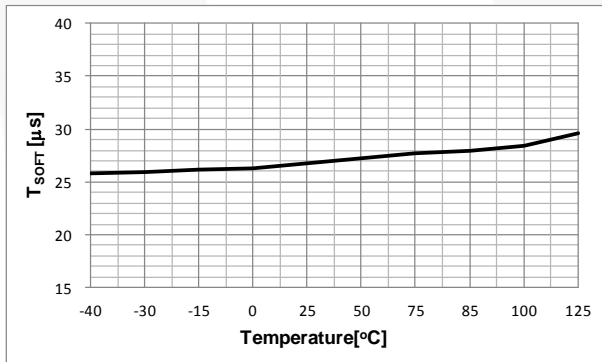

Figure 16. Soft-Start Time vs. Temperature

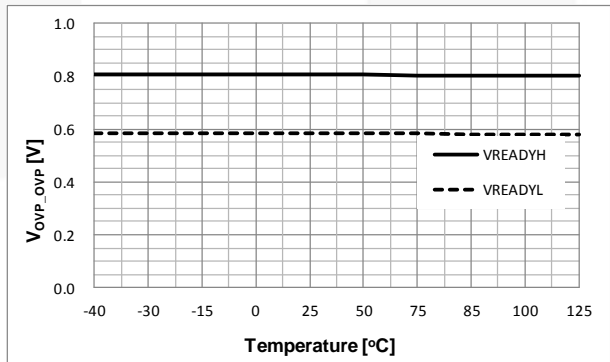

Figure 17. Ready Voltage vs. Temperature

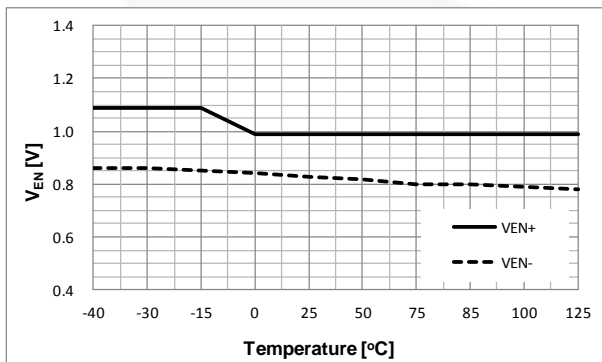

Figure 18. Enable (EN) Threshold Voltage vs. Temperature

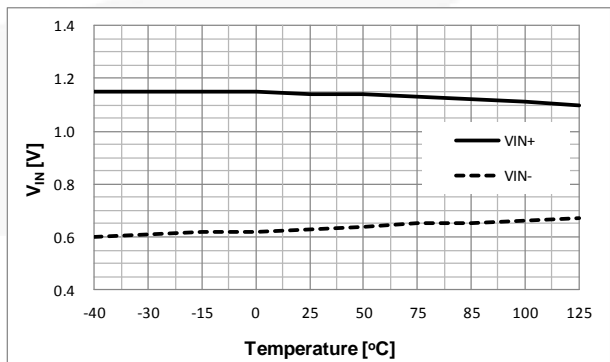

Figure 19. INPUT Threshold Voltage vs. Temperature

Typical Performance Characteristics

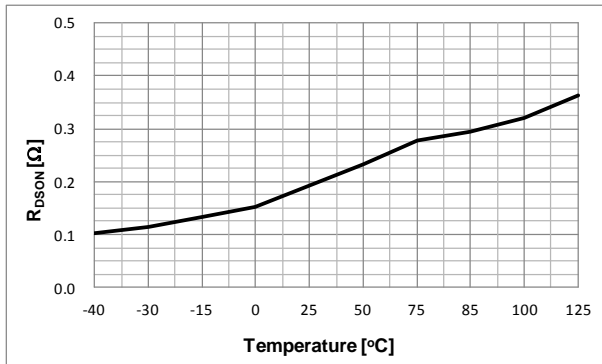

Figure 20. Boost Switch R_{DS(on)} vs. Temperature

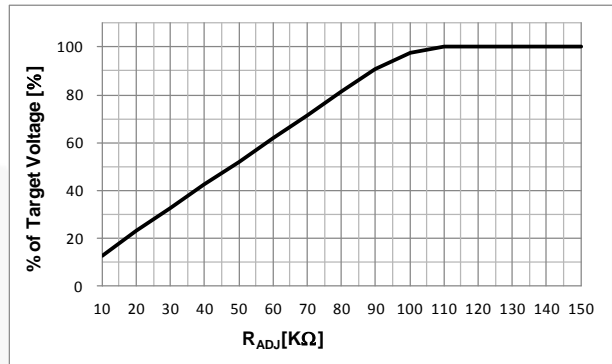

Figure 21. % of Sine Amplitude vs. R_{ADJ}

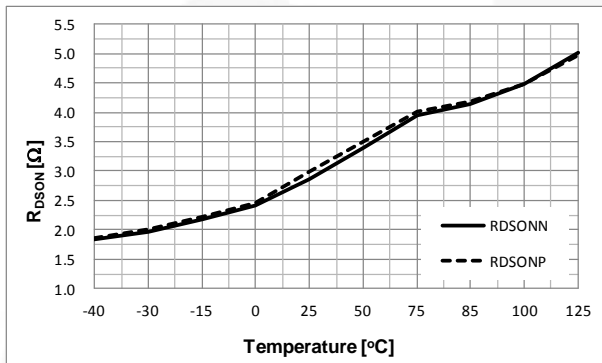

Figure 22. Full-Bridge Switch R_{DS(on)} vs. Temperature

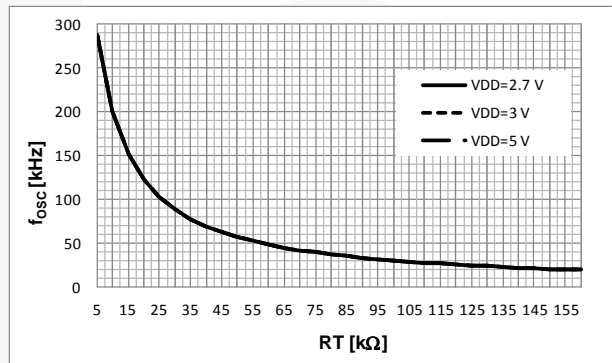

Figure 23. f_{osc} vs. RT

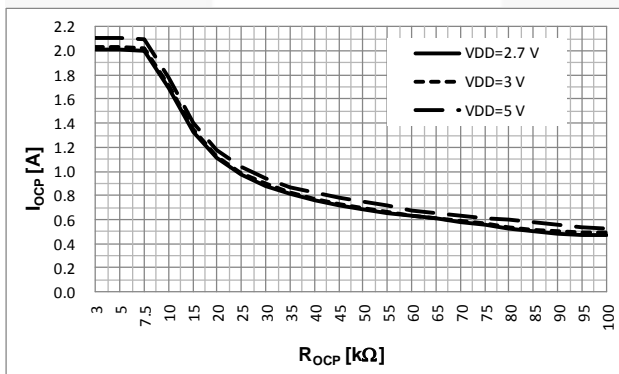
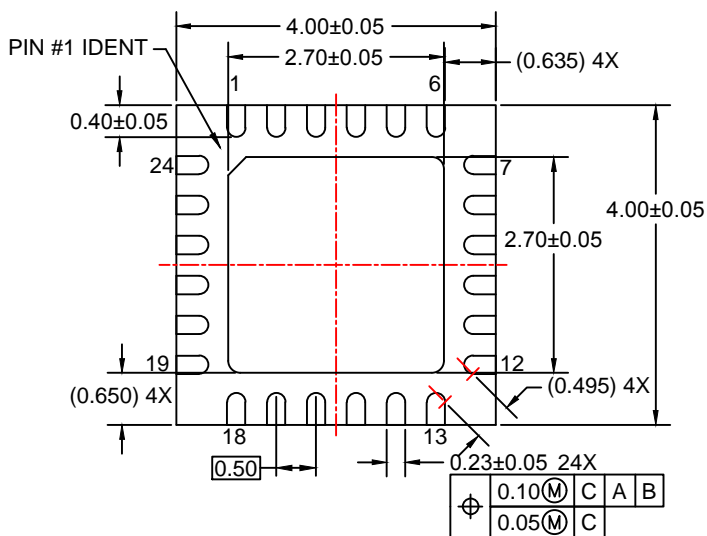
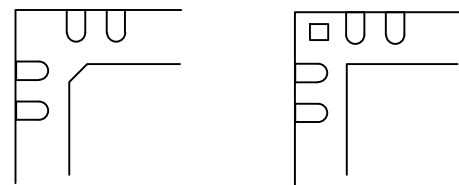
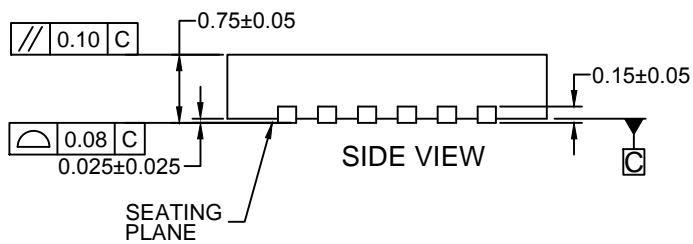
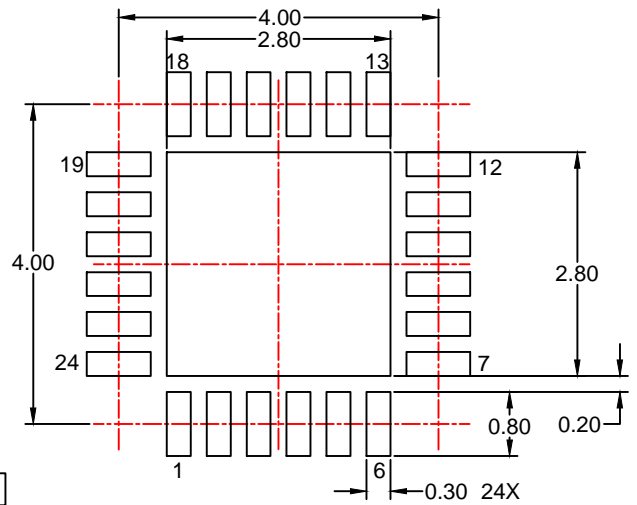
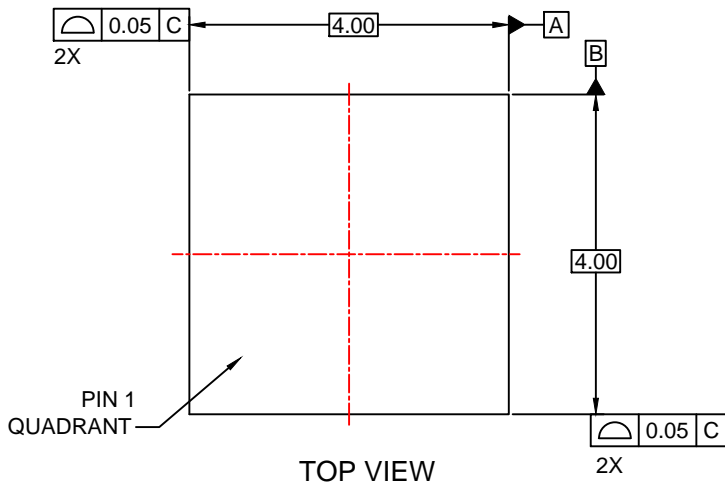

Figure 24. I_{OCP} vs. R_{OCP}



NOTES:

- A. CONFORMS TO JEDEC REGISTRATION MO-220, VARIATION WGGD-6.
- B. DIMENSIONS ARE IN MILLIMETERS.
- C. DIMENSIONS AND TOLERANCES PER ASME Y14.5M, 2009.
- D. LAND PATTERN IPC REFERENCE : QFN50P400X400X80-25W6N.
- E. DRAWING FILENAME: MKT-MLP24Erev5.



ON Semiconductor and  are trademarks of Semiconductor Components Industries, LLC dba ON Semiconductor or its subsidiaries in the United States and/or other countries. ON Semiconductor owns the rights to a number of patents, trademarks, copyrights, trade secrets, and other intellectual property. A listing of ON Semiconductor's product/patent coverage may be accessed at www.onsemi.com/site/pdf/Patent-Marking.pdf. ON Semiconductor reserves the right to make changes without further notice to any products herein. ON Semiconductor makes no warranty, representation or guarantee regarding the suitability of its products for any particular purpose, nor does ON Semiconductor assume any liability arising out of the application or use of any product or circuit, and specifically disclaims any and all liability, including without limitation special, consequential or incidental damages. Buyer is responsible for its products and applications using ON Semiconductor products, including compliance with all laws, regulations and safety requirements or standards, regardless of any support or applications information provided by ON Semiconductor. "Typical" parameters which may be provided in ON Semiconductor data sheets and/or specifications can and do vary in different applications and actual performance may vary over time. All operating parameters, including "Typicals" must be validated for each customer application by customer's technical experts. ON Semiconductor does not convey any license under its patent rights nor the rights of others. ON Semiconductor products are not designed, intended, or authorized for use as a critical component in life support systems or any FDA Class 3 medical devices or medical devices with a same or similar classification in a foreign jurisdiction or any devices intended for implantation in the human body. Should Buyer purchase or use ON Semiconductor products for any such unintended or unauthorized application, Buyer shall indemnify and hold ON Semiconductor and its officers, employees, subsidiaries, affiliates, and distributors harmless against all claims, costs, damages, and expenses, and reasonable attorney fees arising out of, directly or indirectly, any claim of personal injury or death associated with such unintended or unauthorized use, even if such claim alleges that ON Semiconductor was negligent regarding the design or manufacture of the part. ON Semiconductor is an Equal Opportunity/Affirmative Action Employer. This literature is subject to all applicable copyright laws and is not for resale in any manner.

PUBLICATION ORDERING INFORMATION

LITERATURE FULFILLMENT:

Literature Distribution Center for ON Semiconductor
19521 E. 32nd Pkwy, Aurora, Colorado 80011 USA
Phone: 303-675-2175 or 800-344-3860 Toll Free USA/Canada
Fax: 303-675-2176 or 800-344-3867 Toll Free USA/Canada
Email: orderlit@onsemi.com

N. American Technical Support: 800-282-9855 Toll Free
USA/Canada
Europe, Middle East and Africa Technical Support:
Phone: 421 33 790 2910
Japan Customer Focus Center
Phone: 81-3-5817-1050

ON Semiconductor Website: www.onsemi.com
Order Literature: <http://www.onsemi.com/orderlit>
For additional information, please contact your local
Sales Representative