

MOSFET – N-Channel, POWERTRENCH[®]

80 V, 100 A, 4.2 mΩ

FDD86367

Features

- Typical $R_{DS(on)} = 3.3\text{ m}\Omega$ at $V_{GS} = 10\text{ V}$, $I_D = 80\text{ A}$
- Typical $Q_{g(tot)} = 68\text{ nC}$ at $V_{GS} = 10\text{ V}$, $I_D = 80\text{ A}$
- UIS Capability
- This Device is Pb-Free, Halogen Free/BFR Free and is RoHS Compliant

Applications

- PowerTrain Management
- Solenoid and Motor Drivers
- Integrated Starter/Alternator
- Primary Switch for 12 V Systems

MOSFET MAXIMUM RATINGS ($T_J = 25^\circ\text{C}$ unless otherwise noted)

Symbol	Parameter	Ratings	Unit
V_{DS}	Drain-to-Source Voltage	80	V
V_{GS}	Gate-to-Source Voltage	± 20	V
I_D	Drain Current – Continuous ($V_{GS} = 10$) (Note 1) $T_C = 25^\circ\text{C}$	100	A
	Pulsed Drain Current $T_C = 25^\circ\text{C}$	See Figure 4	
EAS	Single Pulse Avalanche Energy (Note 2)	82	mJ
P_D	Power Dissipation	227	W
	Derate Above 25°C	1.52	W/ $^\circ\text{C}$
T_J, T_{STG}	Operating and Storage Temperature	-55 to $+175$	$^\circ\text{C}$
$R_{\theta JC}$	Thermal Resistance, Junction to Case	0.66	$^\circ\text{C}/\text{W}$
$R_{\theta JA}$	Maximum Thermal Resistance, Junction to Ambient (Note 3)	52	$^\circ\text{C}/\text{W}$

Stresses exceeding those listed in the Maximum Ratings table may damage the device. If any of these limits are exceeded, device functionality should not be assumed, damage may occur and reliability may be affected.

1. Current is limited by bondwire configuration.
2. Starting $T_J = 25^\circ\text{C}$, $L = 40\text{ }\mu\text{H}$, $I_{AS} = 64\text{ A}$, $V_{DD} = 80\text{ V}$ during inductor charging and $V_{DD} = 0\text{ V}$ during time in avalanche.
3. $R_{\theta JA}$ is the sum of the junction-to-case and case-to-ambient thermal resistance, where the case thermal reference is defined as the solder mounting surface of the drain pins. $R_{\theta JC}$ is guaranteed by design, while $R_{\theta JA}$ is determined by the board design. The maximum rating presented here is based on mounting on a 1 in² pad of 2oz copper.



ON Semiconductor[®]

www.onsemi.com

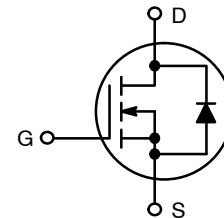

N-Channel

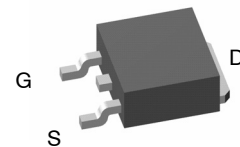

**DPAK3 (TO-252 3 LD)
CASE 369AS**

MARKING DIAGRAM

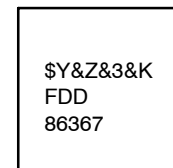

FDD86367 = Specific Device Code
 \$Y = ON Semiconductor Logo
 &Z = Assembly Plant Code
 &3 = 3-Digit Date Code
 &K = 2-Digits Lot Run Traceability Code

ORDERING INFORMATION

See detailed ordering and shipping information on page 2 of this data sheet.

PACKAGE MARKING AND ORDERING INFORMATION

Device	Device Marking	Package	Reel Size	Tape Width	Shipping†
FDD86367	FDD86367	DPAK3 (TO-252 3 LD) (Pb-Free)	13"	16 mm	2500 / Tape & Reel

†For information on tape and reel specifications, including part orientation and tape sizes, please refer to our Tape and Reel Packaging Specifications Brochure, BRD8011/D.

ELECTRICAL CHARACTERISTICS ($T_J = 25^\circ\text{C}$ unless otherwise noted)

Symbol	Parameter	Condition	Min	Typ	Max	Unit
--------	-----------	-----------	-----	-----	-----	------

OFF CHARACTERISTICS

$B_{V_{DS}}$	Drain-to-Source Breakdown Voltage	$I_D = 250 \mu\text{A}$, $V_{GS} = 0 \text{ V}$	80	-	-	V	
I_{DSS}	Drain-to-Source Leakage Current	$V_{DS} = 80 \text{ V}$, $V_{GS} = 0 \text{ V}$	$T_J = 25^\circ\text{C}$	-	-	1	mA
			$T_J = 175^\circ\text{C}$ (Note 4)	-	-	1	mA
I_{GSS}	Gate-to-Source Leakage Current	$V_{GS} = \pm 20 \text{ V}$	-	-	± 100	nA	

ON CHARACTERISTICS

$V_{GS(th)}$	Gate to Source Threshold Voltage	$V_{GS} = V_{DS}$, $I_D = 250 \mu\text{A}$	2	3	4	V	
$R_{DS(on)}$	Drain to Source On Resistance	$I_D = 80 \text{ A}$, $V_{GS} = 10 \text{ V}$	$T_J = 25^\circ\text{C}$	-	3.3	4.2	m Ω
			$T_J = 175^\circ\text{C}$ (Note 4)	-	6.6	8.4	m Ω

DYNAMIC CHARACTERISTICS

C_{iss}	Input Capacitance	$V_{DS} = 40 \text{ V}$, $V_{GS} = 0 \text{ V}$, $f = 1 \text{ MHz}$	-	4840	-	pF
C_{oss}	Output Capacitance		-	814	-	pF
C_{rss}	Reverse Transfer Capacitance		-	31	-	pF
R_g	Gate Resistance	$V_{GS} = 0.5 \text{ V}$, $f = 1 \text{ MHz}$	-	2.3	-	Ω
$Q_{g(TOT)}$	Total Gate Charge	$V_{GS} = 0$ to 10 V	-	68	88	nC
$Q_{g(th)}$	Threshold Gate Charge	$V_{GS} = 0$ to 2 V				
Q_{gs}	Gate-to-Source Gate Charge	$V_{DD} = 40 \text{ V}$, $I_D = 80 \text{ A}$	-	22	-	nC
Q_{gd}	Gate-to-Drain "Miller" Charge		-	14	-	nC

SWITCHING CHARACTERISTICS

t_{on}	Turn-On Time	$V_{DD} = 40 \text{ V}$, $I_D = 80 \text{ A}$, $V_{GS} = 10 \text{ V}$, $R_{GEN} = 6 \Omega$	-	-	104	ns
$t_{d(on)}$	Turn-On Delay		-	20	-	ns
t_r	Rise Time		-	49	-	ns
$t_{d(off)}$	Turn-Off Delay		-	36	-	ns
t_f	Fall Time		-	16	-	ns
t_{off}	Turn-Off Time		-	-	80	ns

DRAIN-SOURCE DIODE CHARACTERISTICS

V_{SD}	Source-to-Drain Diode Voltage	$I_{SD} = 80 \text{ A}$, $V_{GS} = 0 \text{ V}$	-	-	1.3	V
		$I_{SD} = 40 \text{ A}$, $V_{GS} = 0 \text{ V}$	-	-	1.2	V
t_{rr}	Reverse-Recovery Time	$V_{DD} = 64 \text{ V}$, $I_F = 80 \text{ A}$, $dI_{SD}/dt = 100 \text{ A}/\mu\text{s}$	-	68	102	ns
Q_{rr}	Reverse-Recovery Charge		-	66	106	nC

Product parametric performance is indicated in the Electrical Characteristics for the listed test conditions, unless otherwise noted. Product performance may not be indicated by the Electrical Characteristics if operated under different conditions.

4. The maximum value is specified by design at $T_J = 175^\circ\text{C}$. Product is not tested to this condition in production.

TYPICAL CHARACTERISTICS

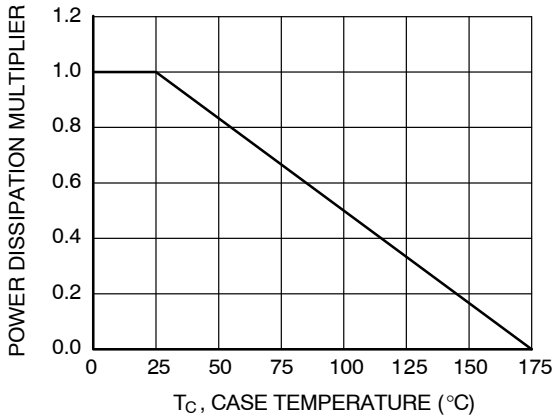

Figure 1. Normalized Power Dissipation vs. Case Temperature

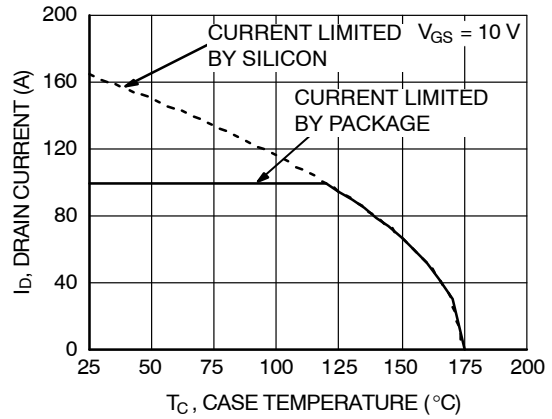

Figure 2. Maximum Continuous Drain Current vs. Case Temperature

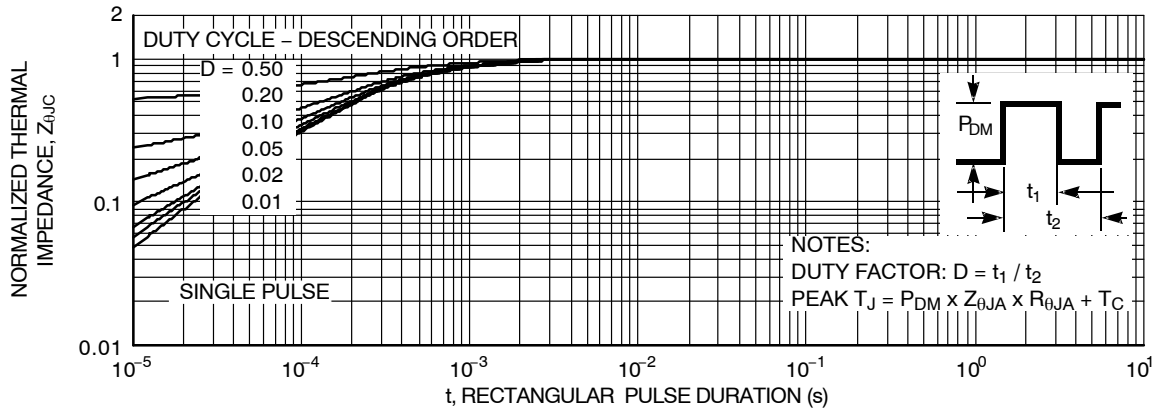

Figure 3. Normalized Maximum Transient Thermal Impedance

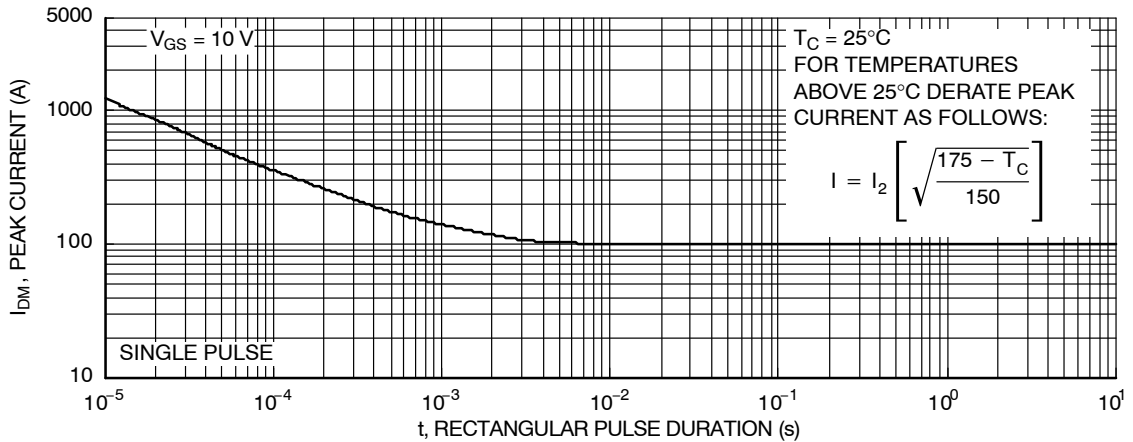

Figure 4. Peak Current Capability

TYPICAL CHARACTERISTICS (continued)

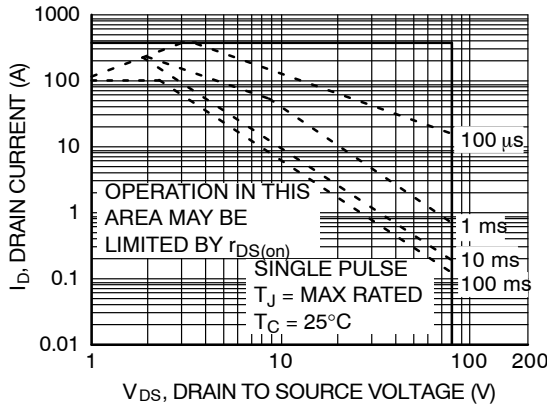
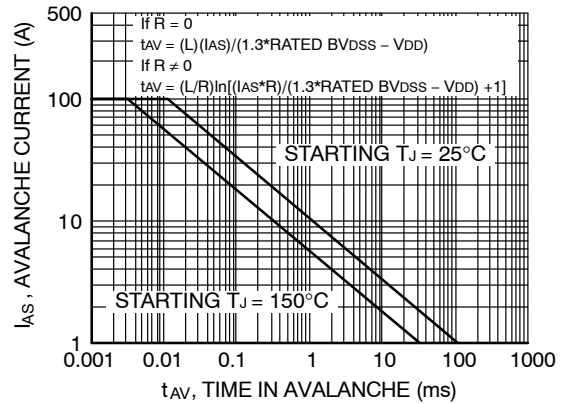

Figure 5. Forward Bias Safe Operating Area



NOTE: Refer to ON Application Notes [AN7514](#) and [AN7515](#)

Figure 6. Unclamped Inductive Switching Capability

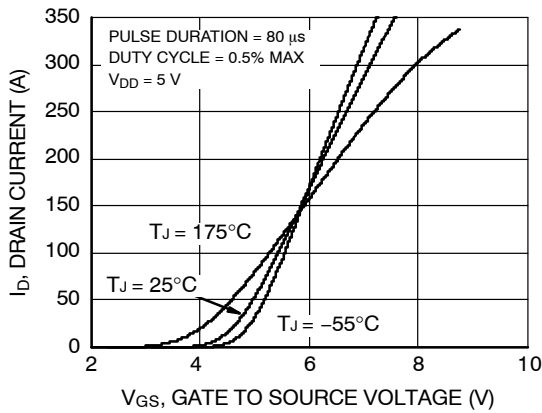

Figure 7. Transfer Characteristics

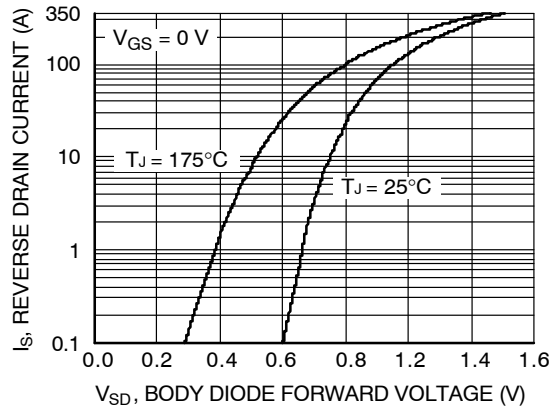

Figure 8. Forward Diode Characteristics

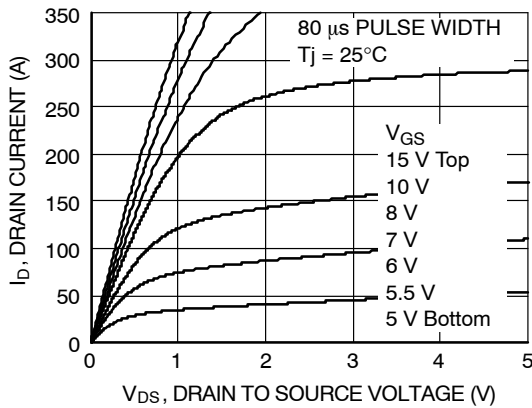

Figure 9. Saturation Characteristics

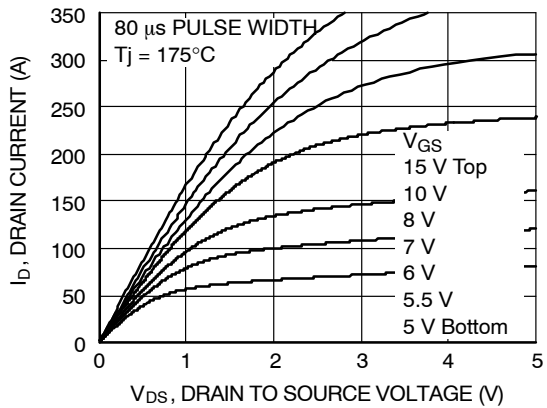

Figure 10. Saturation Characteristics

TYPICAL CHARACTERISTICS (continued)

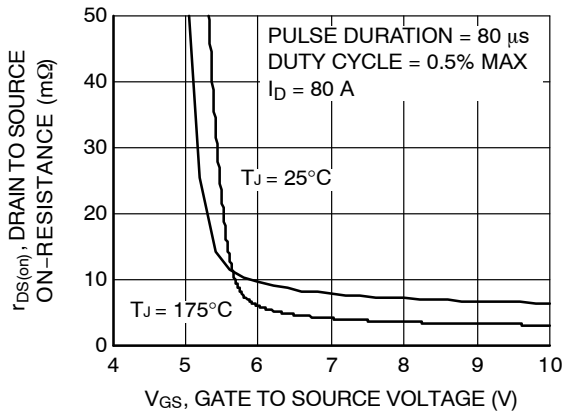

Figure 11. $R_{DS(on)}$ vs. Gate Voltage

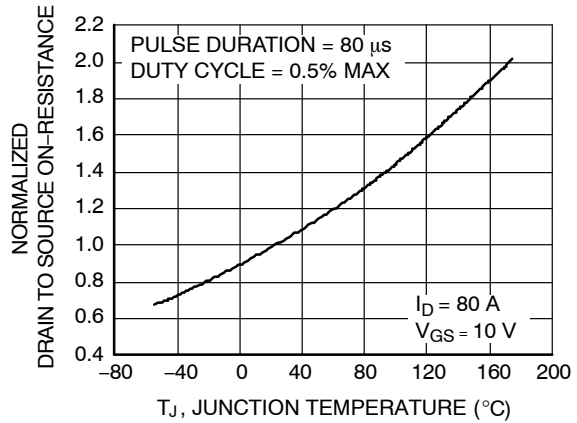

Figure 12. Normalized $R_{DS(on)}$ vs. Junction Temperature

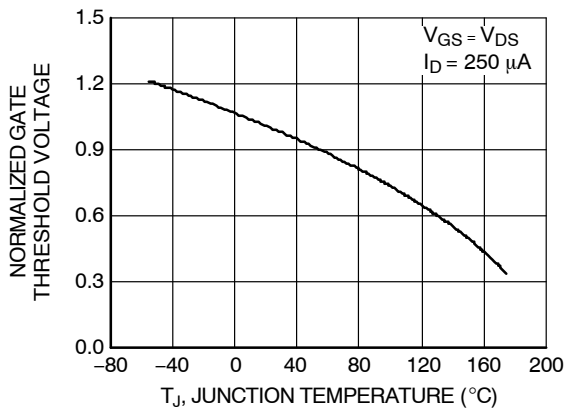

Figure 13. Normalized Gate Threshold Voltage vs. Temperature

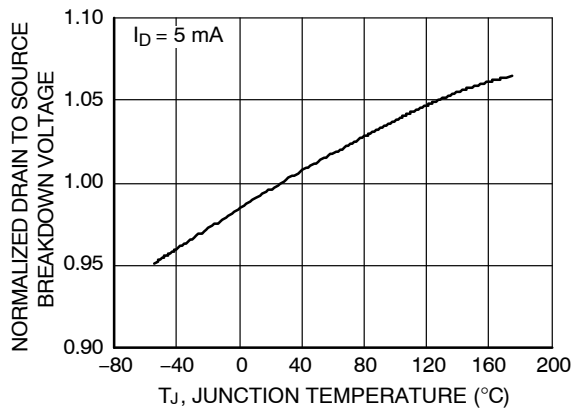

Figure 14. Normalized Drain to Source Breakdown Voltage vs. Junction Temperature

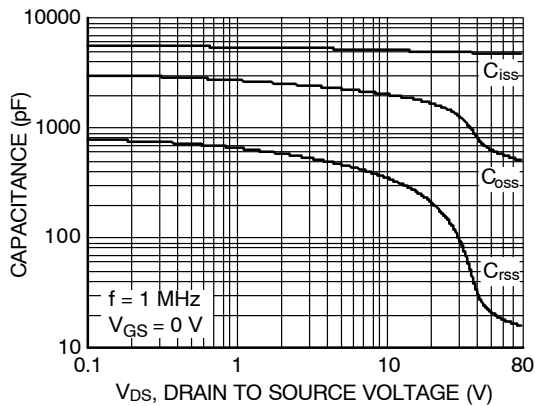

Figure 15. Capacitance vs. Drain to Source Voltage

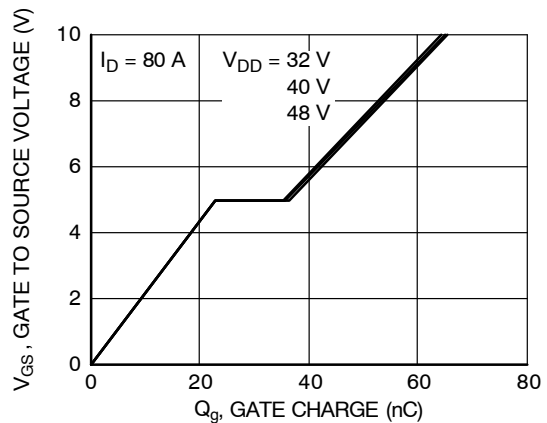

Figure 16. Gate Charge vs. Gate to Source Voltage

POWERTRENCH is registered trademarks of Semiconductor Components Industries, LLC (SCILLC) or its subsidiaries in the United States and/or other countries.

MECHANICAL CASE OUTLINE PACKAGE DIMENSIONS



DPAK3 6.10x6.54x2.29, 4.57P CASE 369AS ISSUE B

DATE 20 DEC 2023

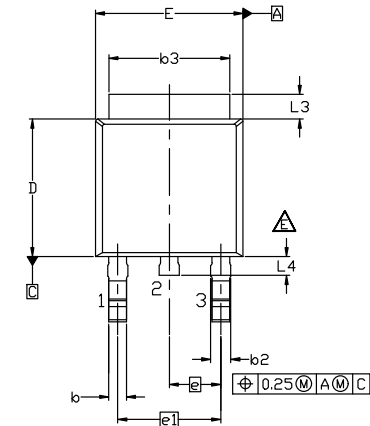

- NOTES: UNLESS OTHERWISE SPECIFIED
- A) THIS PACKAGE CONFORMS TO JEDEC, TO-252, ISSUE F, VARIATION AA.
 - B) ALL DIMENSIONS ARE IN MILLIMETERS.
 - C) DIMENSIONING AND TOLERANCING PER ASME Y14.5M-2018.
 - D) SUPPLIER DEPENDENT MOLD LOCKING HOLES OR CHAMFERED CORNERS OR EDGE PROTRUSION.
 - E) FOR DIODE PRODUCTS, L4 IS 0.25 MM MAX PLASTIC BODY STUB WITHOUT CENTER LEAD.
 - F) DIMENSIONS ARE EXCLUSIVE OF BURRS, MOLD FLASH AND TIE BAR EXTRUSIONS.
 - G) LAND PATTERN RECOMMENDATION IS BASED ON IPC7351A STD TD228P991X239-3N.

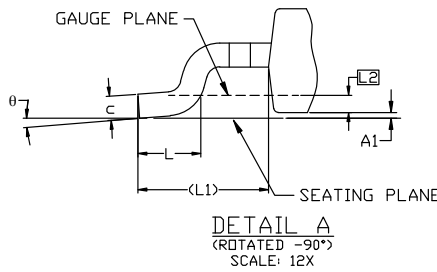
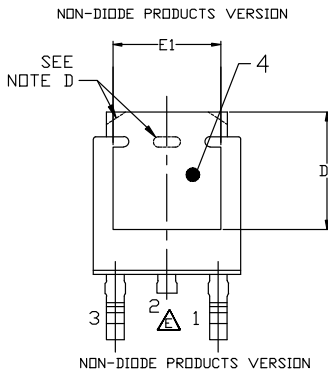

DIM	MILLIMETERS		
	MIN.	NOM.	MAX.
A	2.18	2.29	2.39
A1	0.00	-	0.127
b	0.64	0.77	0.89
b2	0.76	0.95	1.14
b3	5.21	5.34	5.46
c	0.45	0.53	0.61
c2	0.45	0.52	0.58
D	5.97	6.10	6.22
D1	5.21	---	---
E	6.35	6.54	6.73
E1	4.32	---	---
e	2.286 BSC		
e1	4.572 BSC		
H	9.40	9.91	10.41
L	1.40	1.59	1.78
L1	2.90 REF		
L2	0.51 BSC		
L3	0.89	1.08	1.27
L4	---	---	1.02
θ	0°	---	10°

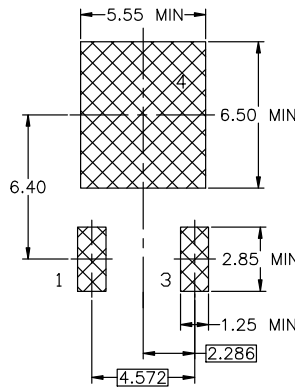

LAND PATTERN RECOMMENDATION

*FOR ADDITIONAL INFORMATION ON OUR PB-FREE STRATEGY AND SOLDERING DETAILS, PLEASE DOWNLOAD THE ON SEMICONDUCTOR SOLDERING AND MOUNTING TECHNIQUES REFERENCE MANUAL, SOLDERM/D.

GENERIC MARKING DIAGRAM*

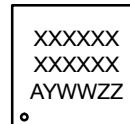

*This information is generic. Please refer to device data sheet for actual part marking. Pb-free indicator, "G" or microdot "•", may or may not be present. Some products may not follow the Generic Marking.

XXXX = Specific Device Code
 A = Assembly Location
 Y = Year
 WW = Work Week
 ZZ = Assembly Lot Code

DOCUMENT NUMBER:	98AON13810G	Electronic versions are uncontrolled except when accessed directly from the Document Repository. Printed versions are uncontrolled except when stamped "CONTROLLED COPY" in red.
DESCRIPTION:	DPAK3 6.10x6.54x2.29, 4.57P	PAGE 1 OF 1

onsemi and ONSEMI are trademarks of Semiconductor Components Industries, LLC dba onsemi or its subsidiaries in the United States and/or other countries. onsemi reserves the right to make changes without further notice to any products herein. onsemi makes no warranty, representation or guarantee regarding the suitability of its products for any particular purpose, nor does onsemi assume any liability arising out of the application or use of any product or circuit, and specifically disclaims any and all liability, including without limitation special, consequential or incidental damages. onsemi does not convey any license under its patent rights nor the rights of others.

onsemi, **Onsemi**, and other names, marks, and brands are registered and/or common law trademarks of Semiconductor Components Industries, LLC dba "**onsemi**" or its affiliates and/or subsidiaries in the United States and/or other countries. **onsemi** owns the rights to a number of patents, trademarks, copyrights, trade secrets, and other intellectual property. A listing of **onsemi**'s product/patent coverage may be accessed at www.onsemi.com/site/pdf/Patent-Marking.pdf. **onsemi** reserves the right to make changes at any time to any products or information herein, without notice. The information herein is provided "as-is" and **onsemi** makes no warranty, representation or guarantee regarding the accuracy of the information, product features, availability, functionality, or suitability of its products for any particular purpose, nor does **onsemi** assume any liability arising out of the application or use of any product or circuit, and specifically disclaims any and all liability, including without limitation special, consequential or incidental damages. Buyer is responsible for its products and applications using **onsemi** products, including compliance with all laws, regulations and safety requirements or standards, regardless of any support or applications information provided by **onsemi**. "Typical" parameters which may be provided in **onsemi** data sheets and/or specifications can and do vary in different applications and actual performance may vary over time. All operating parameters, including "Typicals" must be validated for each customer application by customer's technical experts. **onsemi** does not convey any license under any of its intellectual property rights nor the rights of others. **onsemi** products are not designed, intended, or authorized for use as a critical component in life support systems or any FDA Class 3 medical devices or medical devices with a same or similar classification in a foreign jurisdiction or any devices intended for implantation in the human body. Should Buyer purchase or use **onsemi** products for any such unintended or unauthorized application, Buyer shall indemnify and hold **onsemi** and its officers, employees, subsidiaries, affiliates, and distributors harmless against all claims, costs, damages, and expenses, and reasonable attorney fees arising out of, directly or indirectly, any claim of personal injury or death associated with such unintended or unauthorized use, even if such claim alleges that **onsemi** was negligent regarding the design or manufacture of the part. **onsemi** is an Equal Opportunity/Affirmative Action Employer. This literature is subject to all applicable copyright laws and is not for resale in any manner.

ADDITIONAL INFORMATION

TECHNICAL PUBLICATIONS:

Technical Library: www.onsemi.com/design/resources/technical-documentation
onsemi Website: www.onsemi.com

ONLINE SUPPORT: www.onsemi.com/support

For additional information, please contact your local Sales Representative at www.onsemi.com/support/sales