

# MOSFET – N-Channel, POWERTRENCH<sup>®</sup>, SyncFET™

**30 V, 14.8 A, 6.0 mΩ**

## FDMC7672S

### General Description

This FDMC7672S is produced using onsemi's advanced POWERTRENCH process that has been especially tailored to minimize the on-state resistance. This device is well suited for Power Management and load switching applications common in Notebook Computers and Portable Battery packs.

### Features

- Max  $R_{DS(on)}$  = 6.0 mΩ at  $V_{GS} = 10\text{ V}$ ,  $I_D = 14.8\text{ A}$
- Max  $R_{DS(on)}$  = 7.1 mΩ at  $V_{GS} = 4.5\text{ V}$ ,  $I_D = 12.4\text{ A}$
- High Performance Technology for Extremely Low  $R_{DS(on)}$
- Pb-Free, Halide Free and RoHS Compliant

### Applications

- DC-DC Buck Converters
- Notebook Battery Power Management
- Load Switch in Notebook

### MAXIMUM RATINGS ( $T_A = 25^\circ\text{C}$ unless otherwise noted)

Symbol	Parameter	Value	Unit
$V_{DS}$	Drain to Source Voltage	30	V
$V_{GS}$	Gate to Source Voltage	±20	V
$I_D$	Drain Current:		A
	Continuous, $T_C = 25^\circ\text{C}$	18	
	Continuous, $T_A = 25^\circ\text{C}$ (Note 1a)	14.8	
	Pulsed	45	
$E_{AS}$	Single Pulse Avalanche Energy (Note 3)	60	mJ
$P_D$	Power Dissipation:		W
	$T_C = 25^\circ\text{C}$ $T_A = 25^\circ\text{C}$ (Note 1a)	36 2.3	
$T_J, T_{STG}$	Operating and Storage Junction Temperature Range	-55 to +150	°C

Stresses exceeding those listed in the Maximum Ratings table may damage the device. If any of these limits are exceeded, device functionality should not be assumed, damage may occur and reliability may be affected.

$V_{DS}$	$R_{DS(on)}$ MAX	$I_D$ MAX
30 V	6.0 mΩ @ 10 V	14.8 A
	7.1 mΩ @ 4.5 V	

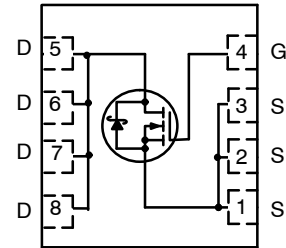

N-CHANNEL MOSFET

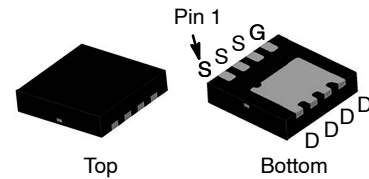

WDFN8 3.3 × 3.3, 0.65P  
CASE 511DQ  
(Option A)

### MARKING DIAGRAM

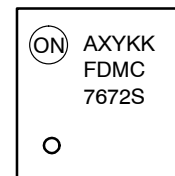

A = Assembly Location  
XY = 2-Digit Date Code  
KK = 2-Digit Lot Run Traceability Code  
FDMC7672S = Specific Device Code

### ORDERING INFORMATION

Device	Package	Shipping†
FDMC7672S	WDFN8 (Pb-Free, Halide Free)	3000 / Tape & Reel

†For information on tape and reel specifications, including part orientation and tape sizes, please refer to our Tape and Reel Packaging Specification Brochure, [BRD8011/D](#).

# FDMC7672S

## THERMAL CHARACTERISTICS

Symbol	Parameter	Value	Unit
$R_{\theta JC}$	Thermal Resistance, Junction to Case	3.5	°C/W
$R_{\theta JA}$	Thermal Resistance, Junction to Ambient (Note 1a)	53	

## ELECTRICAL CHARACTERISTICS ( $T_J = 25^\circ\text{C}$ unless otherwise noted)

Symbol	Parameter	Test Condition	Min	Typ	Max	Unit
--------	-----------	----------------	-----	-----	-----	------

### OFF CHARACTERISTICS

$BV_{DSS}$	Drain to Source Breakdown Voltage	$I_D = 1\text{ mA}, V_{GS} = 0\text{ V}$	30	–	–	V
$\Delta BV_{DSS} / \Delta T_J$	Breakdown Voltage Temperature Coefficient	$I_D = 10\text{ mA}$ , referenced to $25^\circ\text{C}$	–	12	–	mV/°C
$I_{DSS}$	Zero Gate Voltage Drain Current	$V_{DS} = 24\text{ V}, V_{GS} = 0\text{ V}$	–	–	1	mA
$I_{GSS}$	Gate to Source Leakage Current	$V_{GS} = 20\text{ V}, V_{DS} = 0\text{ V}$	–	–	100	nA

### ON CHARACTERISTICS (Note 2)

$V_{GS(th)}$	Gate to Source Threshold Voltage	$V_{GS} = V_{DS}, I_D = 1\text{ mA}$	1.2	1.6	3.0	V
$\Delta V_{GS(th)} / \Delta T_J$	Gate to Source Threshold Voltage Temperature Coefficient	$I_D = 10\text{ mA}$ , referenced to $25^\circ\text{C}$	–	–6	–	mV/°C
$R_{DS(on)}$	Static Drain to Source On Resistance	$V_{GS} = 10\text{ V}, I_D = 14.8\text{ A}$	–	5.0	6.0	mΩ
		$V_{GS} = 4.5\text{ V}, I_D = 12.4\text{ A}$	–	6.1	7.1	
		$V_{GS} = 10\text{ V}, I_D = 14.8\text{ A}, T_J = 125^\circ\text{C}$	–	5.9	9.0	
$g_{FS}$	Forward Transconductance	$V_{DS} = 5\text{ V}, I_D = 14.8\text{ A}$	–	78	–	S

### DYNAMIC CHARACTERISTICS

$C_{iss}$	Input Capacitance	$V_{DS} = 15\text{ V}, V_{GS} = 0\text{ V}, f = 1\text{ MHz}$	–	1895	2520	pF
$C_{oss}$	Output Capacitance		–	770	1025	pF
$C_{rss}$	Reverse Transfer Capacitance		–	85	130	pF
$R_g$	Gate Resistance	$f = 1\text{ MHz}$	–	1.2	3.2	Ω

### SWITCHING CHARACTERISTICS

$t_{d(on)}$	Turn-On Delay Time	$V_{DD} = 15\text{ V}, I_D = 14.8\text{ A}, V_{GS} = 10\text{ V}, R_{GEN} = 6\ \Omega$	–	11	21	ns
$t_r$	Rise Time		–	4	10	ns
$t_{d(off)}$	Turn-Off Delay Time		–	26	42	ns
$t_f$	Fall Time		–	3	10	ns
$Q_g$	Total Gate Charge	$V_{GS} = 0\text{ V to } 10\text{ V}, V_{DD} = 15\text{ V}, I_D = 14.8\text{ A}$	–	30	42	nC
		$V_{GS} = 0\text{ V to } 4.5\text{ V}, V_{DD} = 15\text{ V}, I_D = 14.8\text{ A}$	–	14	20	nC
$Q_{gs}$	Gate to Source Gate Charge	$V_{DD} = 15\text{ V}, I_D = 14.8\text{ A}$	–	5.3	–	nC
$Q_{gd}$	Gate to Drain "Miller" Charge	$V_{DD} = 15\text{ V}, I_D = 14.8\text{ A}$	–	4.0	–	nC

# FDMC7672S

## ELECTRICAL CHARACTERISTICS ( $T_J = 25^\circ\text{C}$ unless otherwise noted) (continued)

Symbol	Parameter	Test Condition	Min	Typ	Max	Unit
<b>DRAIN-SOURCE DIODE CHARACTERISTICS</b>						
$V_{SD}$	Source to Drain Diode Forward Voltage	$V_{GS} = 0\text{ V}, I_S = 14.8\text{ A}$ (Note 2)	–	0.8	1.3	V
		$V_{GS} = 0\text{ V}, I_S = 1.9\text{ A}$ (Note 2)	–	0.5	1.2	
$t_{rr}$	Reverse Recovery Time	$I_F = 14.8\text{ A}, di/dt = 300\text{ A}/\mu\text{s}$	–	29	45	ns
$Q_{rr}$	Reverse Recovery Charge		–	28	44	nC

Product parametric performance is indicated in the Electrical Characteristics for the listed test conditions, unless otherwise noted. Product performance may not be indicated by the Electrical Characteristics if operated under different conditions.

### NOTES:

- $R_{\theta JA}$  is determined with the device mounted on a 1 in<sup>2</sup> pad 2 oz copper pad on a 1.5 x 1.5 in. board of FR-4 material.  $R_{\theta JC}$  is guaranteed by design while  $R_{\theta CA}$  is determined by the user's board design.

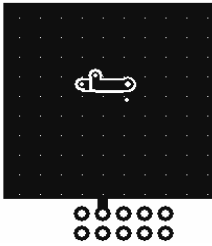

- a)  $53^\circ\text{C}/\text{W}$  when mounted on a 1 in<sup>2</sup> pad of 2 oz copper.

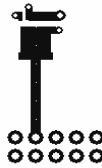

- b)  $125^\circ\text{C}/\text{W}$  when mounted on a minimum pad of 2 oz copper.

- Pulse Test: Pulse Width < 300  $\mu\text{s}$ , Duty cycle < 2.0%.
- $E_{AS}$  of 60 mJ is based on starting  $T_J = 25^\circ\text{C}$ ,  $L = 1\text{ mH}$ ,  $I_{AS} = 11\text{ A}$ ,  $V_{DD} = 27\text{ V}$ ,  $V_{GS} = 10\text{ V}$ . 100% test at  $L = 3\text{ mH}$ ,  $I_{AS} = 4.8\text{ A}$ .

TYPICAL CHARACTERISTICS

( $T_J = 25^\circ\text{C}$  unless otherwise noted)

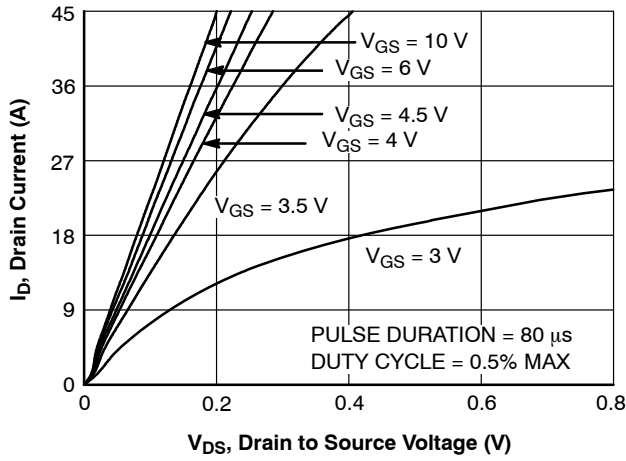

Figure 1. On-Region Characteristics

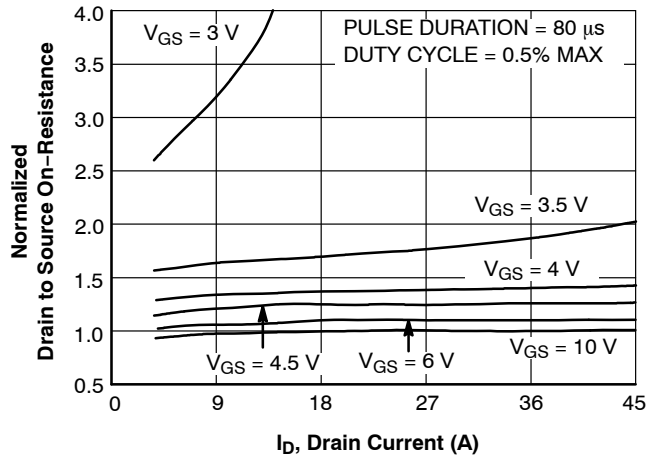

Figure 2. Normalized On-Resistance vs. Drain Current and Gate Voltage

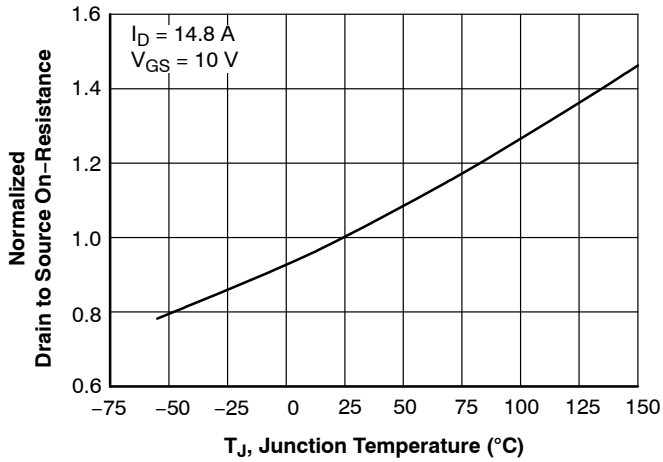

Figure 3. Normalized On-Resistance vs. Junction Temperature

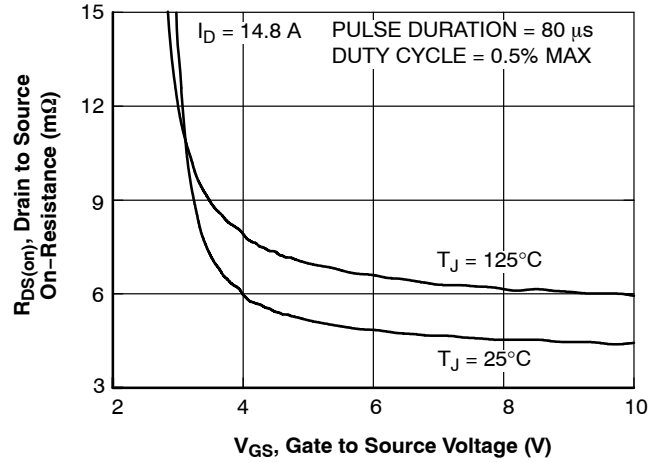

Figure 4. On-Resistance vs. Gate to Source Voltage

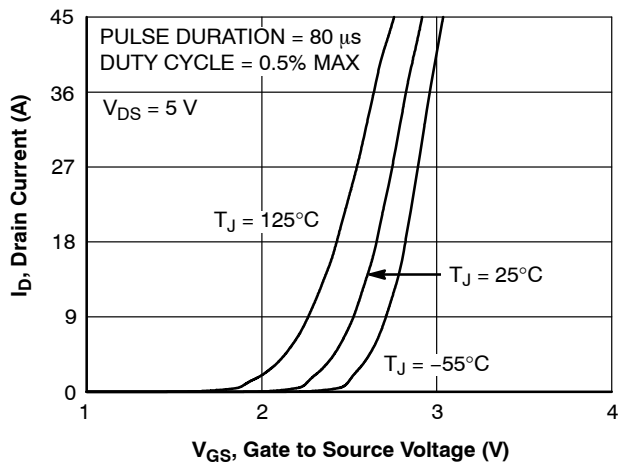

Figure 5. Transfer Characteristics

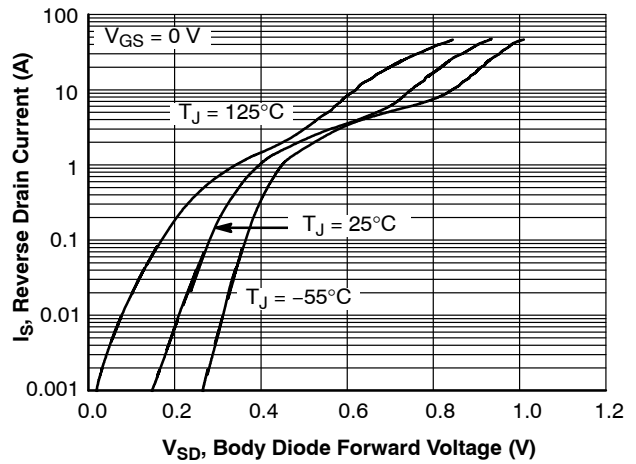

Figure 6. Source to Drain Diode Forward Voltage vs. Source Current

# FDMC7672S

## TYPICAL CHARACTERISTICS (continued)

( $T_J = 25^\circ\text{C}$  unless otherwise noted)

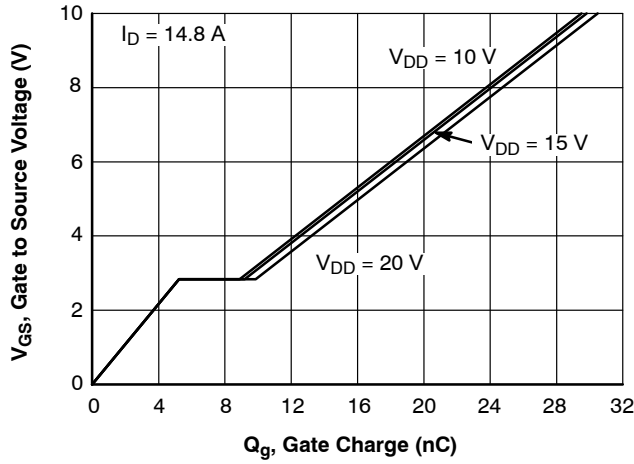

Figure 7. Gate Charge Characteristics

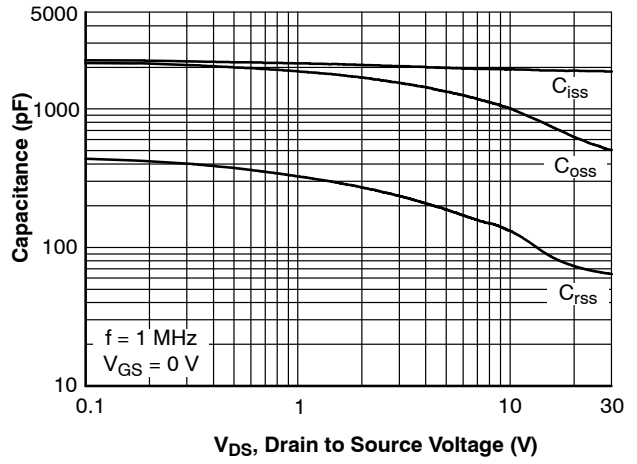

Figure 8. Capacitance vs. Drain to Source Voltage

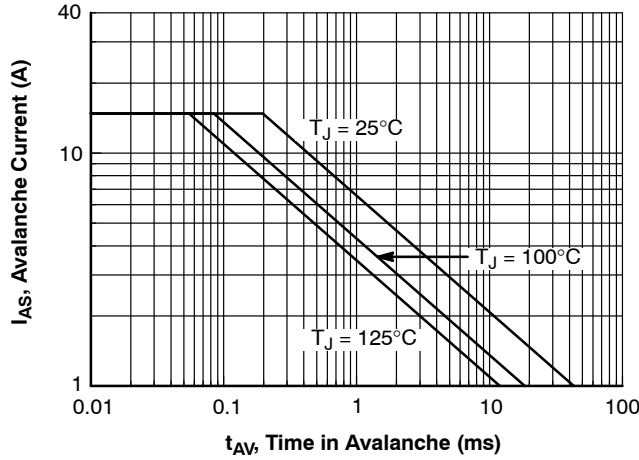

Figure 9. Unclamped Inductive Switching Capability

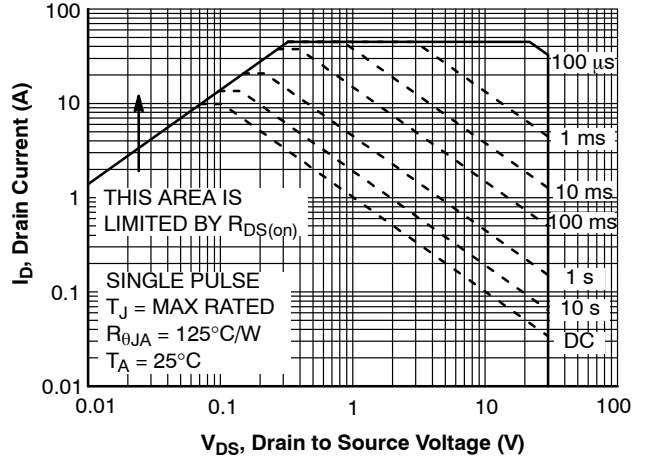

Figure 10. Forward Bias Safe Operating Area

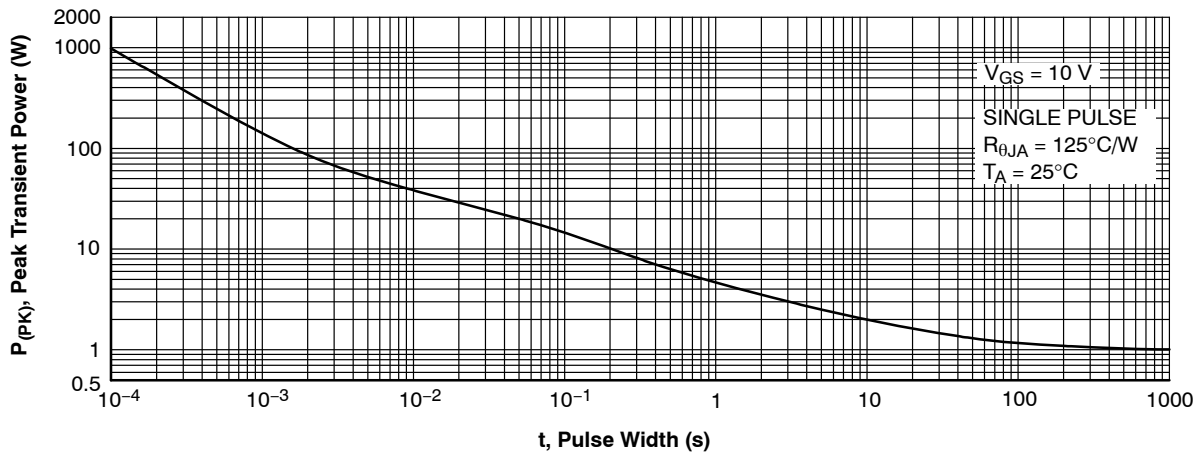

Figure 11. Single Pulse Maximum Power Dissipation

# FDMC7672S

## TYPICAL CHARACTERISTICS (continued)

( $T_J = 25^\circ\text{C}$  unless otherwise noted)

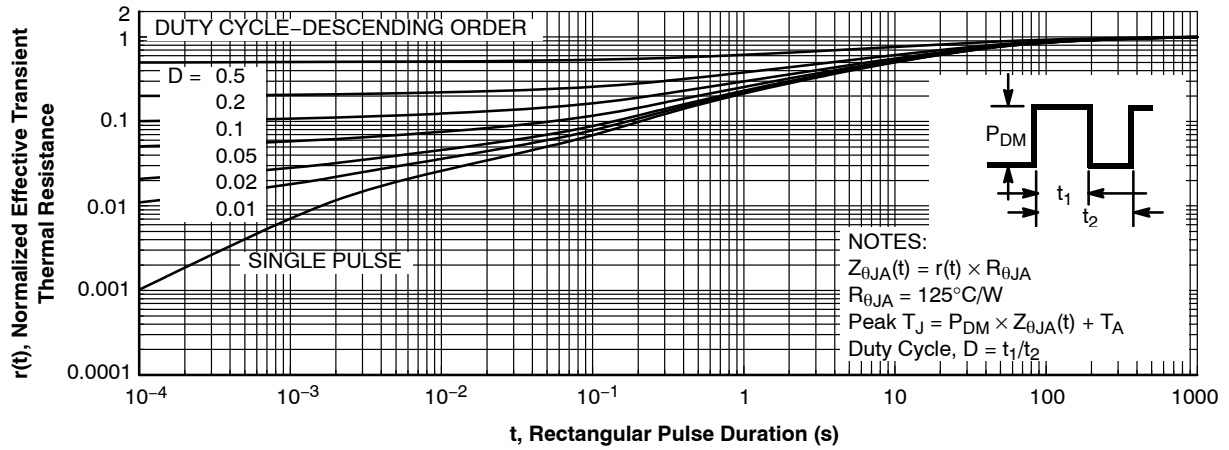

Figure 12. Junction-to-Ambient Transient Thermal Response Curve

TYPICAL CHARACTERISTICS (continued)

**SyncFET Schottky Body Diode Characteristics**

onsemi's SyncFET process embeds a Schottky diode in parallel with POWERTRENCH MOSFET. This diode exhibits similar characteristics to a discrete external Schottky diode in parallel with a MOSFET. Figure 13 shows the reverse recovery characteristic of the FDMC7672S.

Schottky barrier diodes exhibit significant leakage at high temperature and high reverse voltage. This will increase the power in the device.

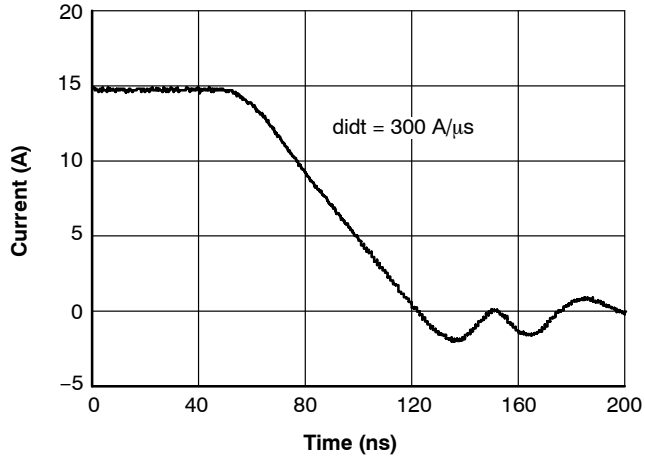

**Figure 13. SyncFET Body Diode Reverse Recovery Characteristics**

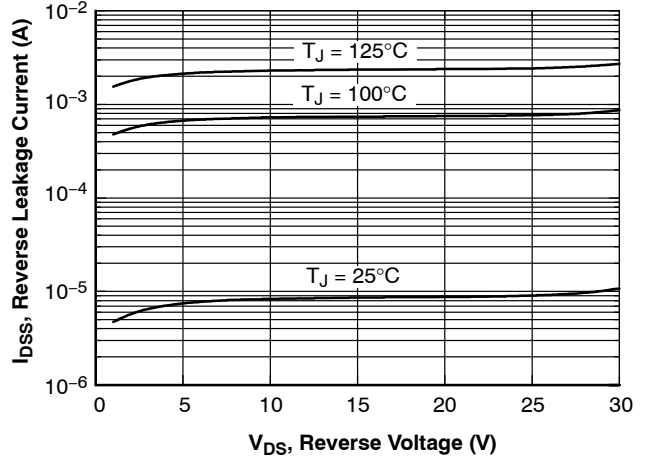

**Figure 14. SyncFET Body Diode Reverse Leakage vs. Drain-Source Voltage**

POWERTRENCH is a registered trademark of Semiconductor Components Industries, LLC dba "onsemi" or its affiliates and/or subsidiaries in the United States and/or other countries.

SyncFET is a trademark of Semiconductor Components Industries, LLC dba "onsemi" or its affiliates and/or subsidiaries in the United States and/or other countries.

# MECHANICAL CASE OUTLINE

## PACKAGE DIMENSIONS

ON Semiconductor®



### WDFN8 3.3x3.3, 0.65P

#### CASE 511DQ

#### ISSUE O

DATE 31 OCT 2016

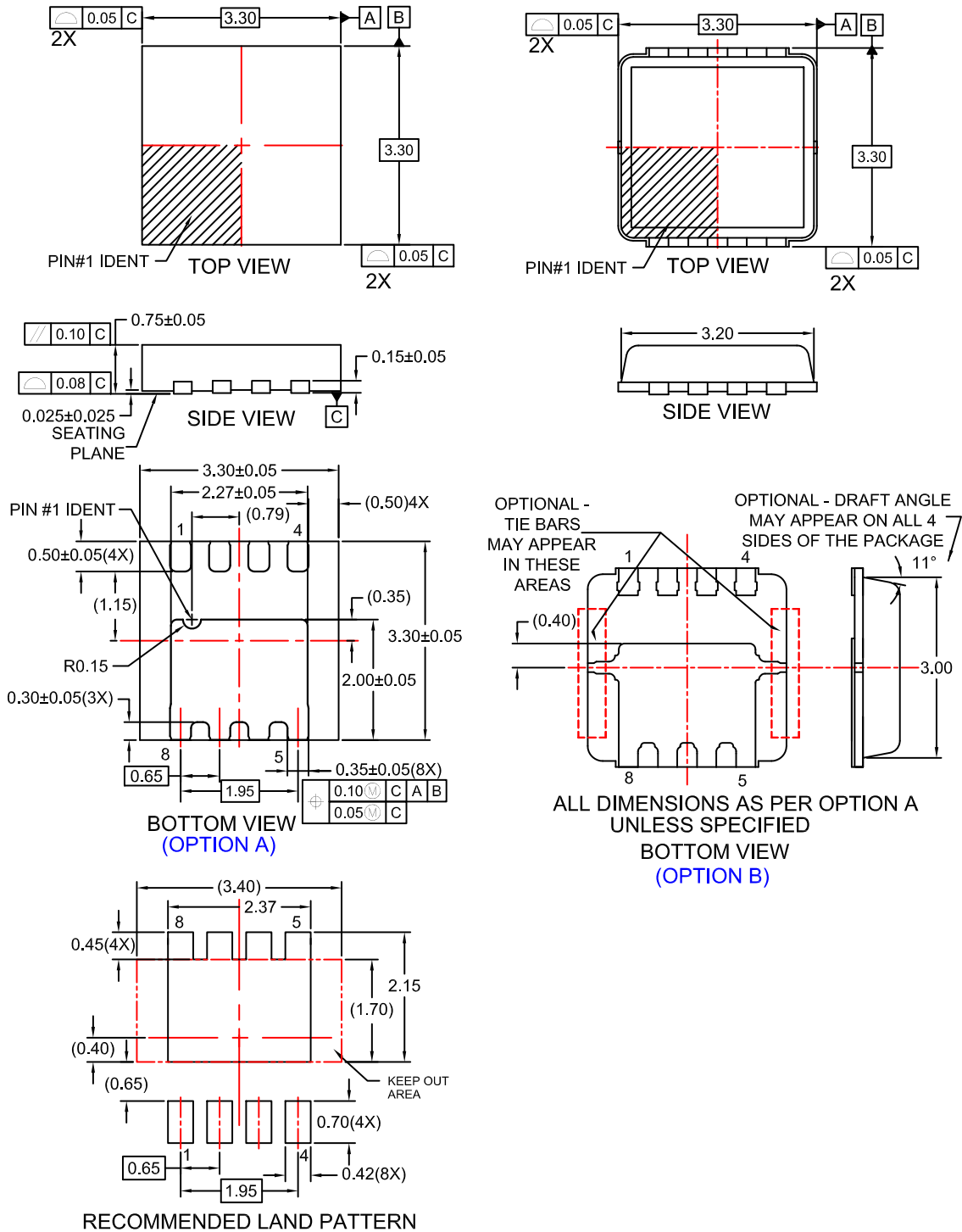

<b>DOCUMENT NUMBER:</b>	<b>98AON13648G</b>	Electronic versions are uncontrolled except when accessed directly from the Document Repository. Printed versions are uncontrolled except when stamped "CONTROLLED COPY" in red.
<b>DESCRIPTION:</b>	<b>WDFN8 3.3X3.3, 0.65P</b>	<b>PAGE 1 OF 2</b>

ON Semiconductor and are trademarks of Semiconductor Components Industries, LLC dba ON Semiconductor or its subsidiaries in the United States and/or other countries. ON Semiconductor reserves the right to make changes without further notice to any products herein. ON Semiconductor makes no warranty, representation or guarantee regarding the suitability of its products for any particular purpose, nor does ON Semiconductor assume any liability arising out of the application or use of any product or circuit, and specifically disclaims any and all liability, including without limitation special, consequential or incidental damages. ON Semiconductor does not convey any license under its patent rights nor the rights of others.



**WDFN8 3.3x3.3, 0.65P**  
CASE 511DQ  
ISSUE O

DATE 31 OCT 2016

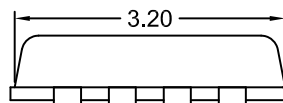
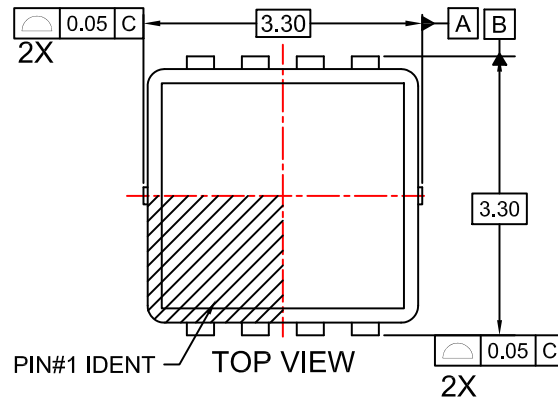

SIDE VIEW

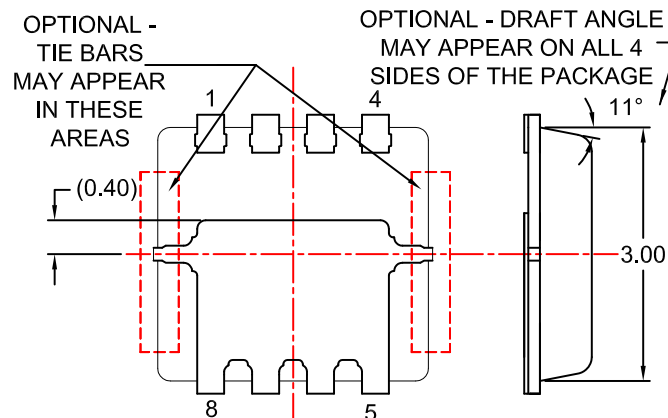

ALL DIMENSIONS AS PER OPTION A  
UNLESS SPECIFIED

BOTTOM VIEW  
(OPTION C)

**NOTES:**

- A. PACKAGE DOES NOT FULLY CONFORM TO JEDEC REGISTRATION MO-240.
- B. DIMENSIONS ARE IN MILLIMETERS.
- C. DIMENSIONS AND TOLERANCES PER ASME Y14.5M, 2009.
- D. LAND PATTERN RECOMMENDATION IS EXISTING INDUSTRY LAND PATTERN
- E. DIMENSIONS DO NOT INCLUDE BURRS OR MOLD FLASH. BURRS OR MOLD FLASH SHALL NOT EXCEED 0.10MM.

<b>DOCUMENT NUMBER:</b>	<b>98AON13648G</b>	Electronic versions are uncontrolled except when accessed directly from the Document Repository. Printed versions are uncontrolled except when stamped "CONTROLLED COPY" in red.
<b>DESCRIPTION:</b>	<b>WDFN8 3.3X3.3, 0.65P</b>	<b>PAGE 2 OF 2</b>

ON Semiconductor and are trademarks of Semiconductor Components Industries, LLC dba ON Semiconductor or its subsidiaries in the United States and/or other countries. ON Semiconductor reserves the right to make changes without further notice to any products herein. ON Semiconductor makes no warranty, representation or guarantee regarding the suitability of its products for any particular purpose, nor does ON Semiconductor assume any liability arising out of the application or use of any product or circuit, and specifically disclaims any and all liability, including without limitation special, consequential or incidental damages. ON Semiconductor does not convey any license under its patent rights nor the rights of others.

**onsemi**, **Onsemi**, and other names, marks, and brands are registered and/or common law trademarks of Semiconductor Components Industries, LLC dba "**onsemi**" or its affiliates and/or subsidiaries in the United States and/or other countries. **onsemi** owns the rights to a number of patents, trademarks, copyrights, trade secrets, and other intellectual property. A listing of **onsemi**'s product/patent coverage may be accessed at [www.onsemi.com/site/pdf/Patent-Marking.pdf](http://www.onsemi.com/site/pdf/Patent-Marking.pdf). **onsemi** reserves the right to make changes at any time to any products or information herein, without notice. The information herein is provided "as-is" and **onsemi** makes no warranty, representation or guarantee regarding the accuracy of the information, product features, availability, functionality, or suitability of its products for any particular purpose, nor does **onsemi** assume any liability arising out of the application or use of any product or circuit, and specifically disclaims any and all liability, including without limitation special, consequential or incidental damages. Buyer is responsible for its products and applications using **onsemi** products, including compliance with all laws, regulations and safety requirements or standards, regardless of any support or applications information provided by **onsemi**. "Typical" parameters which may be provided in **onsemi** data sheets and/or specifications can and do vary in different applications and actual performance may vary over time. All operating parameters, including "Typicals" must be validated for each customer application by customer's technical experts. **onsemi** does not convey any license under any of its intellectual property rights nor the rights of others. **onsemi** products are not designed, intended, or authorized for use as a critical component in life support systems or any FDA Class 3 medical devices or medical devices with a same or similar classification in a foreign jurisdiction or any devices intended for implantation in the human body. Should Buyer purchase or use **onsemi** products for any such unintended or unauthorized application, Buyer shall indemnify and hold **onsemi** and its officers, employees, subsidiaries, affiliates, and distributors harmless against all claims, costs, damages, and expenses, and reasonable attorney fees arising out of, directly or indirectly, any claim of personal injury or death associated with such unintended or unauthorized use, even if such claim alleges that **onsemi** was negligent regarding the design or manufacture of the part. **onsemi** is an Equal Opportunity/Affirmative Action Employer. This literature is subject to all applicable copyright laws and is not for resale in any manner.

## ADDITIONAL INFORMATION

### TECHNICAL PUBLICATIONS:

Technical Library: [www.onsemi.com/design/resources/technical-documentation](http://www.onsemi.com/design/resources/technical-documentation)  
onsemi Website: [www.onsemi.com](http://www.onsemi.com)

### ONLINE SUPPORT: [www.onsemi.com/support](http://www.onsemi.com/support)

For additional information, please contact your local Sales Representative at [www.onsemi.com/support/sales](http://www.onsemi.com/support/sales)