



Is Now Part of



ON Semiconductor®

To learn more about ON Semiconductor, please visit our website at
www.onsemi.com

Please note: As part of the Fairchild Semiconductor integration, some of the Fairchild orderable part numbers will need to change in order to meet ON Semiconductor's system requirements. Since the ON Semiconductor product management systems do not have the ability to manage part nomenclature that utilizes an underscore (_), the underscore (_) in the Fairchild part numbers will be changed to a dash (-). This document may contain device numbers with an underscore (_). Please check the ON Semiconductor website to verify the updated device numbers. The most current and up-to-date ordering information can be found at www.onsemi.com. Please email any questions regarding the system integration to Fairchild_questions@onsemi.com.

ON Semiconductor and the ON Semiconductor logo are trademarks of Semiconductor Components Industries, LLC dba ON Semiconductor or its subsidiaries in the United States and/or other countries. ON Semiconductor owns the rights to a number of patents, trademarks, copyrights, trade secrets, and other intellectual property. A listing of ON Semiconductor's product/patent coverage may be accessed at www.onsemi.com/site/pdf/Patent-Marking.pdf. ON Semiconductor reserves the right to make changes without further notice to any products herein. ON Semiconductor makes no warranty, representation or guarantee regarding the suitability of its products for any particular purpose, nor does ON Semiconductor assume any liability arising out of the application or use of any product or circuit, and specifically disclaims any and all liability, including without limitation special, consequential or incidental damages. Buyer is responsible for its products and applications using ON Semiconductor products, including compliance with all laws, regulations and safety requirements or standards, regardless of any support or applications information provided by ON Semiconductor. "Typical" parameters which may be provided in ON Semiconductor data sheets and/or specifications can and do vary in different applications and actual performance may vary over time. All operating parameters, including "Typicals" must be validated for each customer application by customer's technical experts. ON Semiconductor does not convey any license under its patent rights nor the rights of others. ON Semiconductor products are not designed, intended, or authorized for use as a critical component in life support systems or any FDA Class 3 medical devices or medical devices with a same or similar classification in a foreign jurisdiction or any devices intended for implantation in the human body. Should Buyer purchase or use ON Semiconductor products for any such unintended or unauthorized application, Buyer shall indemnify and hold ON Semiconductor and its officers, employees, subsidiaries, affiliates, and distributors harmless against all claims, costs, damages, and expenses, and reasonable attorney fees arising out of, directly or indirectly, any claim of personal injury or death associated with such unintended or unauthorized use, even if such claim alleges that ON Semiconductor was negligent regarding the design or manufacture of the part. ON Semiconductor is an Equal Opportunity/Affirmative Action Employer. This literature is subject to all applicable copyright laws and is not for resale in any manner.

FDY4000CZ

Complementary N & P-Channel PowerTrench® MOSFET

Features

Q1: N-Channel

- Max $r_{DS(on)}$ = 0.7Ω at $V_{GS} = 4.5V$, $I_D = 600mA$
- Max $r_{DS(on)}$ = 0.85Ω at $V_{GS} = 2.5V$, $I_D = 500mA$
- Max $r_{DS(on)}$ = 1.25Ω at $V_{GS} = 1.8V$, $I_D = 150 mA$

Q2: P-Channel

- Max $r_{DS(on)}$ = 1.2Ω at $V_{GS} = -4.5V$, $I_D = -350mA$
- Max $r_{DS(on)}$ = 1.6Ω at $V_{GS} = -2.5V$, $I_D = -300mA$
- Max $r_{DS(on)}$ = 2.7Ω at $V_{GS} = -1.8V$, $I_D = -150mA$
- ESD protection diode (note 3)
- RoHS Compliant



General Description

This Complementary N & P-Channel MOSFET has been designed using Fairchild Semiconductor's advanced PowerTrench® process to optimize the $r_{DS(on)}$ @ $V_{GS} = 2.5V$ and specify the $r_{DS(on)}$ @ $V_{GS} = 1.8V$.

Applications

- Level shifting
- Power Supply Converter Circuits
- Load/Power Switching Cell Phones, Pagers

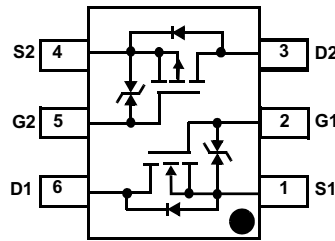
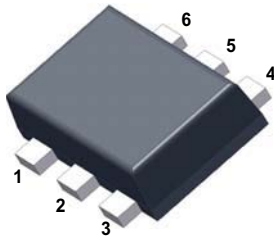

MOSFET Maximum Ratings $T_C = 25^\circ C$ unless otherwise noted

Symbol	Parameter	Q1	Q2	Units
V_{DS}	Drain to Source Voltage	20	-20	V
V_{GS}	Gate to Source Voltage	±12	±8	V
I_D	Drain Current -Continuous (Note 1a)	600	-350	mA
	-Pulsed	1000	-1000	
P_D	Power Dissipation (Steady State) (Note 1a) (Note 1b)	625		mW
		446		
T_J, T_{STG}	Operating and Storage Jaunting Temperature Range	-55 to 150		°C

Thermal Characteristics

$R_{\theta JA}$	Thermal Resistance, Junction to Ambient (Note 1a)	200	°C/W
$R_{\theta JA}$	Thermal Resistance, Junction to Ambient (Note 1b)	280	

Package Marking and Ordering Information

Device Marking	Device	Package	Reel Size	Tape Width	Quantity
E	FDY4000CZ	SC89-6	7"	8mm	3000units

Electrical Characteristics $T_J = 25^\circ\text{C}$ unless otherwise noted

Symbol	Parameter	Test Conditions	Type	Min	Typ	Max	Units
Off Characteristics							
B_{VDSS}	Drain to Source Breakdown Voltage	$I_D = 250\mu\text{A}, V_{GS} = 0\text{V}$ $I_D = -250\mu\text{A}, V_{GS} = 0\text{V}$	Q1 Q2	20 -20			V
$\frac{\Delta B_{VDSS}}{\Delta T_J}$	Breakdown Voltage Temperature Coefficient	$I_D = 250\mu\text{A}$, referenced to 25°C $I_D = -250\mu\text{A}$, referenced to 25°C	Q1 Q2		15 -15		mV/ $^\circ\text{C}$
I_{DSS}	Zero Gate Voltage Drain Current	$V_{DS} = 16\text{V}, V_{GS} = 0\text{V}$ $V_{DS} = -16\text{V}, V_{GS} = 0\text{V}$	Q1 Q2			1 -3	μA
I_{GSS}	Gate-Body Leakage	$V_{GS} = \pm 12\text{V}, V_{DS} = 0\text{V}$ $V_{GS} = \pm 4.5\text{V}, V_{DS} = 0\text{V}$ $V_{GS} = \pm 8\text{V}, V_{DS} = 0\text{V}$	Q1 Q1 Q2			± 10 ± 1 ± 10	μA

On Characteristics (note 2)

$V_{GS(th)}$	Gate to Source Threshold Voltage	$V_{GS} = V_{DS}, I_D = 250\mu\text{A}$ $V_{GS} = V_{DS}, I_D = -250\mu\text{A}$	Q1 Q2	0.6 -0.6	1.0 -1.0	1.5 -1.5	V
$\frac{\Delta V_{GS(th)}}{\Delta T_J}$	Gate to Source Threshold Voltage Temperature Coefficient	$I_D = 250\mu\text{A}$, referenced to 25°C $I_D = -250\mu\text{A}$, referenced to 25°C	Q1 Q2		-3 3		mV/ $^\circ\text{C}$
$r_{DS(on)}$	Drain to Source On Resistance	$V_{GS} = 4.5\text{V}, I_D = 600\text{mA}$ $V_{GS} = 2.5\text{V}, I_D = 500\text{mA}$ $V_{GS} = 1.8\text{V}, I_D = 150\text{mA}$, $V_{GS} = 4.5\text{V}, I_D = 600\text{mA}, T_J = 125^\circ\text{C}$ $V_{GS} = -4.5\text{V}, I_D = -350\text{mA}$ $V_{GS} = -2.5\text{V}, I_D = -300\text{mA}$ $V_{GS} = -1.8\text{V}, I_D = -150\text{mA}$ $V_{GS} = -4.5\text{V}, I_D = -350\text{mA}, T_J = 125^\circ\text{C}$	Q1 Q2		0.30 0.40 0.80 0.35 0.5 0.8 1.3 0.7	0.70 0.85 1.25 1.00 1.2 1.6 2.7 1.6	Ω
g_{FS}	Forward Transconductance	$V_{DS} = 5\text{V}, I_D = 600\text{mA}$ $V_{DS} = -5\text{V}, I_D = -350\text{mA}$	Q1 Q2		1.8 1		S

Dynamic Characteristics

C_{iss}	Input Capacitance	Q1 $V_{DS} = 10\text{V}, V_{GS} = 0\text{V}, f = 1\text{MHz}$	Q1 Q2		60 100		pF
C_{oss}	Output Capacitance	Q2	Q1 Q2		20 30		pF
C_{rss}	Reverse Transfer Capacitance	$V_{DS} = -10\text{V}, V_{GS} = 0\text{V}, f = 1\text{MHz}$	Q1 Q2		10 15		pF

Switching Characteristics

$t_{d(on)}$	Turn-On Delay Time	Q1 $V_{DD} = 10\text{V}, I_D = 1\text{A}$, $V_{GS} = 4.5\text{V}, R_g = 6\Omega$	Q1 Q2		6 6	12 12	ns
t_r	Rise Time		Q1 Q2		8 13	16 23	ns
$t_{d(off)}$	Turn-Off Delay Time	Q2 $V_{DD} = -10\text{V}, I_D = -0.5\text{A}$, $V_{GS} = -4.5\text{V}, R_g = 6\Omega$	Q1 Q2		8 8	16 16	ns
t_f	Fall Time		Q1 Q2		2.4 1	4.8 2	ns
Q_g	Total Gate Charge	Q1 $V_{DS} = 10\text{V}, I_D = 600\text{mA}, V_{GS} = 4.5\text{V}$	Q1 Q2		0.8 1.0	1.1 1.4	nC
Q_{gs}	Gate to Source Gate Charge	Q1 Q2	Q1 Q2		0.16 0.2		nC
Q_{gd}	Gate to Drain "Miller" Charge	Q1 Q2 $V_{DS} = -10\text{V}, I_D = -350\text{mA}, V_{GS} = -4.5\text{V}$	Q1 Q2		0.26 0.3		nC

Electrical Characteristics $T_J = 25^\circ\text{C}$ unless otherwise noted

Symbol	Parameter	Test Conditions	Type	Min	Typ	Max	Units
--------	-----------	-----------------	------	-----	-----	-----	-------

Drain-Source Diode Characteristics

V_{SD}	Source to Drain Diode Forward Voltage	$V_{GS} = 0\text{V}, I_S = 150\text{mA}$ (Note 2) $V_{GS} = 0\text{V}, I_S = -150\text{mA}$ (Note 2)	Q1 Q2		0.7 -0.8	1.2 -1.2	V
t_{rr}	Reverse Recovery Time	Q1 $I_F = 600\text{mA}, di/dt = 100\text{A}/\mu\text{s}$	Q1 Q2		8 11		ns
Q_{rr}	Reverse Recovery Charge	Q2 $I_F = -350\text{mA}, di/dt = 100\text{A}/\mu\text{s}$	Q1 Q2		1 2		nC

Notes:

1: $R_{\theta JA}$ is the sum of the junction-to-case and case-to-ambient thermal resistance where the case thermal reference is defined as the solder mounting surface of the drain pins. $R_{\theta JC}$ is guaranteed by design while $R_{\theta JA}$ is determined by the user's board design.



a) $200^\circ\text{C}/\text{W}$ when mounted on a 1 in^2 pad of 2 oz copper

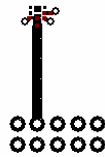

b) $280^\circ\text{C}/\text{W}$ when mounted on a minimum pad of 2 oz copper

Scale 1:1 on letter size paper

2: Pulse Test : Pulse Width < 300us, Duty Cycle < 2.0%

3: The diode connected between the gate and source serves only as protection against ESD. No gate overvoltage rating is implied.

Typical Characteristics Q1 (N-Channel)

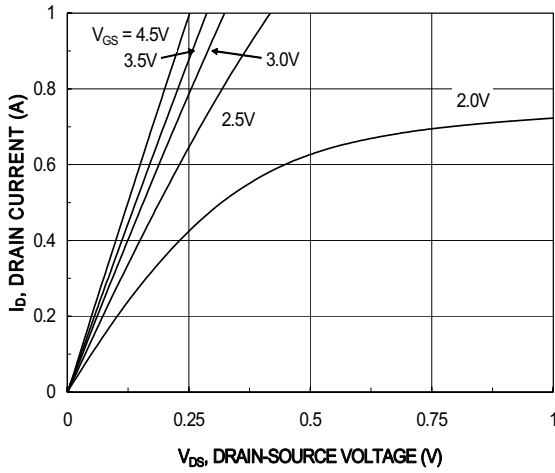

Figure 1. On-Region Characteristics

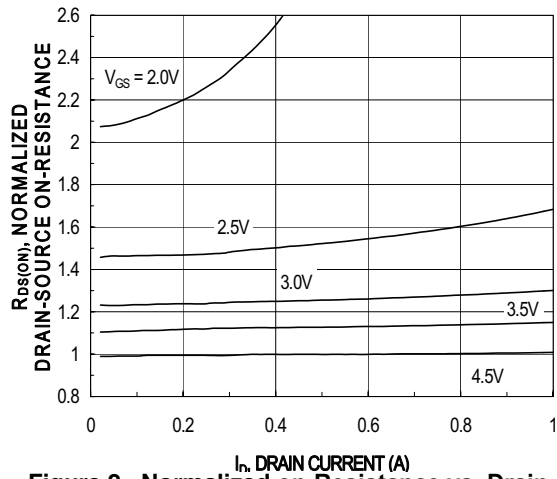

Figure 2. Normalized on-Resistance vs. Drain Current and Gate Voltage

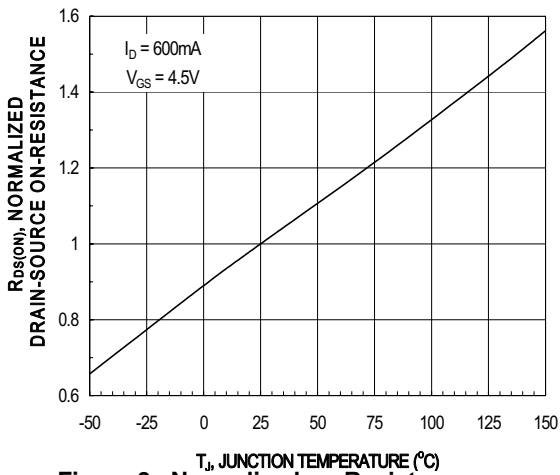

Figure 3. Normalized on-Resistance vs. Temperature

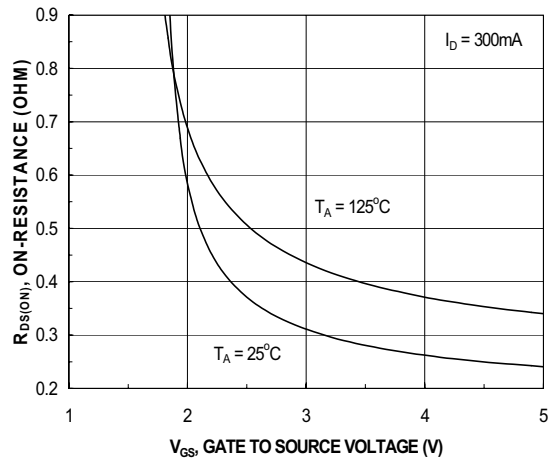

Figure 4. On-Resistance vs. Gate-to-Source Voltage

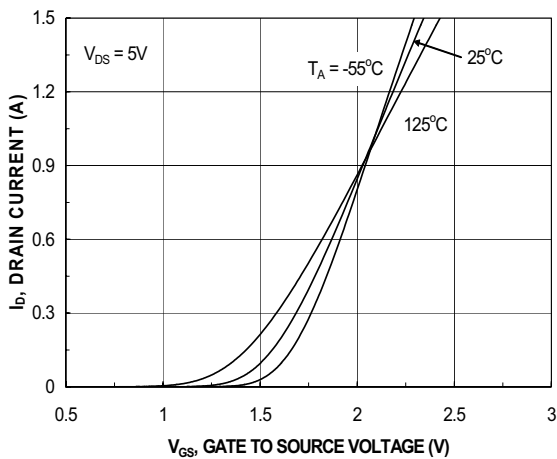

Figure 5. Transfer Characteristics

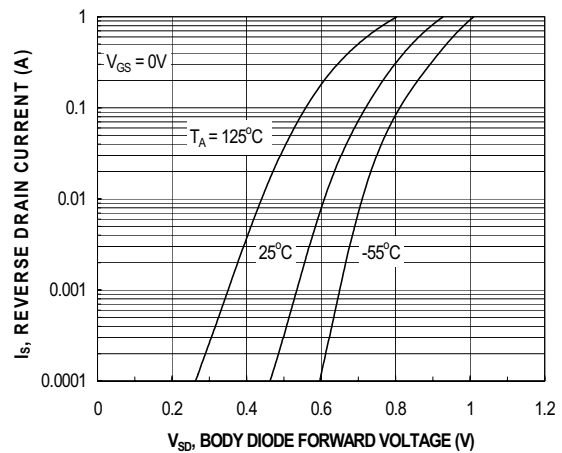

Figure 6. Source to Drain Diode Forward Voltage vs. Source Current and Temperature

Typical Characteristics Q1 (N-Channel)

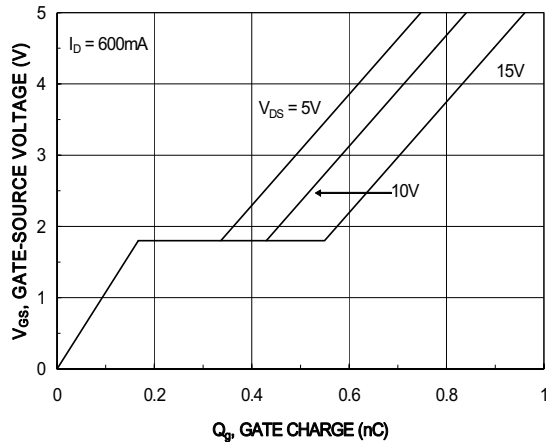

Figure 7. Gate Charge Characteristics

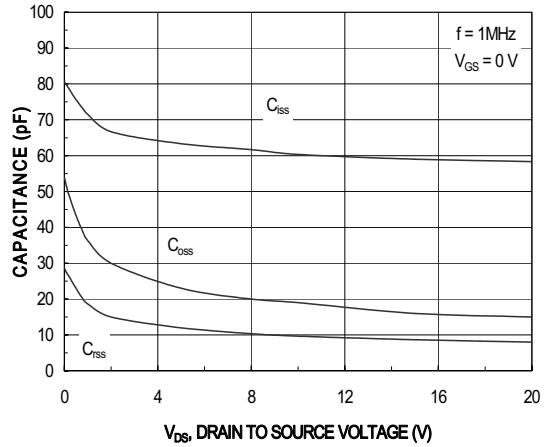

Figure 8. Capacitance vs. Drain to source voltage

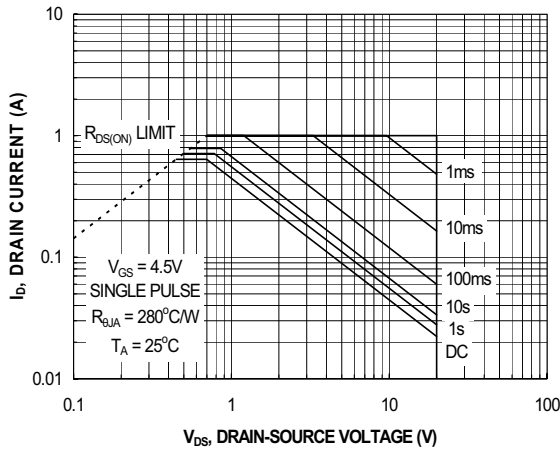

Figure 9. Maximum Safe Operating Area

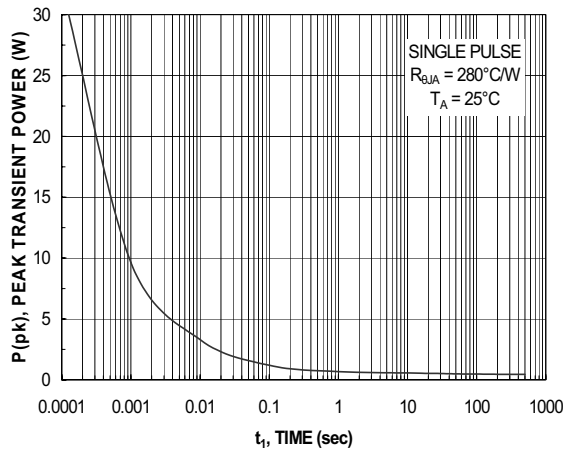

Figure 10. Single Pulse Maximum Power Dissipation

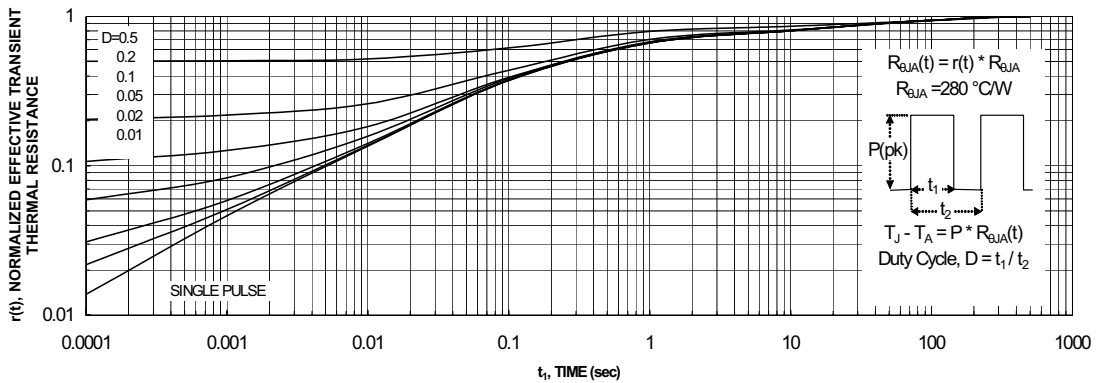

Figure 11. Transient Thermal Response Curve
Thermal characterization performed using the conditions described in Note 1b.
Transient thermal response will change depending on the circuit board design.

Typical Characteristics Q2 (P-Channel)

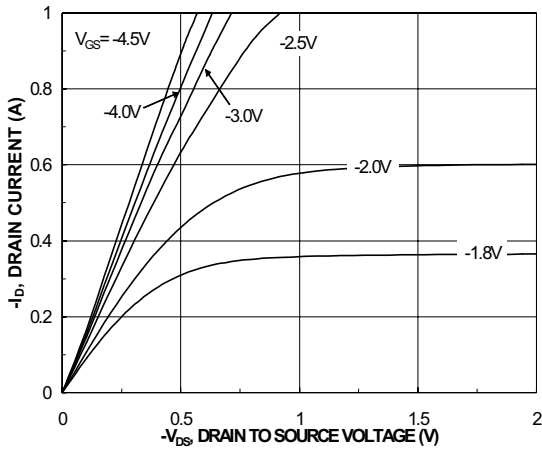

Figure 12. On-Region Characteristics

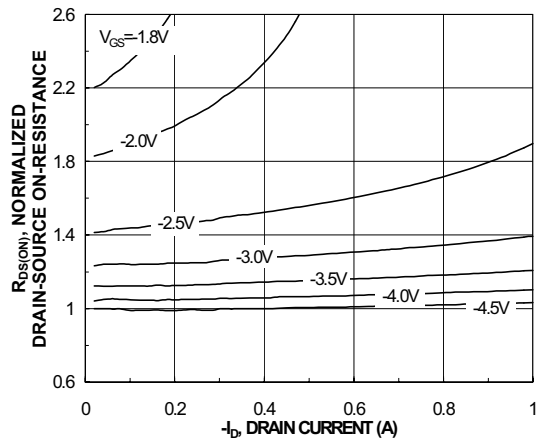

Figure 13. Normalized on-Resistance vs. Drain Current and Gate Voltage

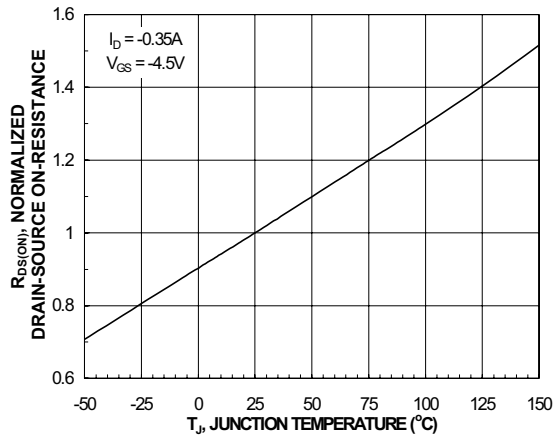

Figure 14. Normalized on-Resistance vs. Temperature

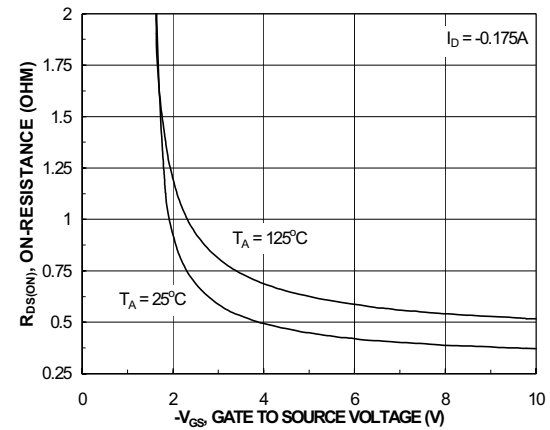

Figure 15. On-Resistance vs. Gate-to-Source Voltage

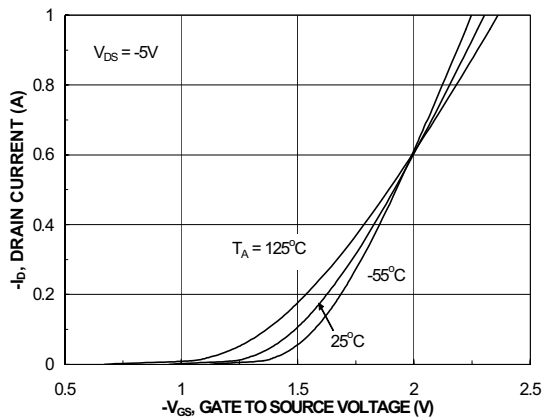

Figure 16. Transfer Characteristics

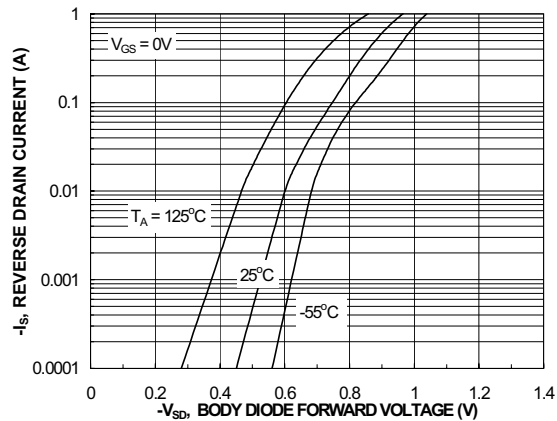

Figure 17. Source to Drain Diode Forward Voltage vs. Source Current and Temperature

Typical Characteristics Q2 (P-Channel)

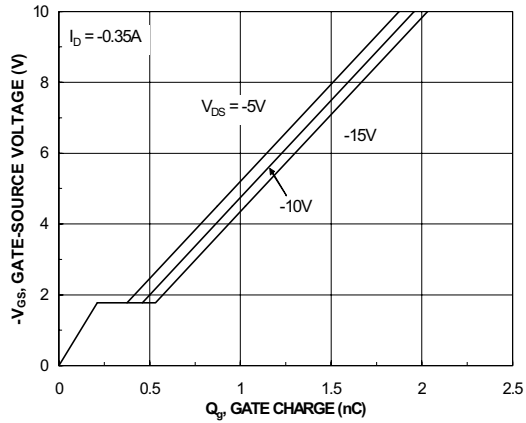

Figure 18. Gate Charge Characteristics

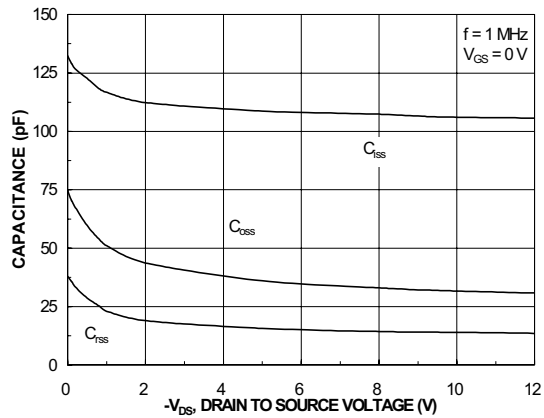

Figure 19. Capacitance vs. Drain to source voltage

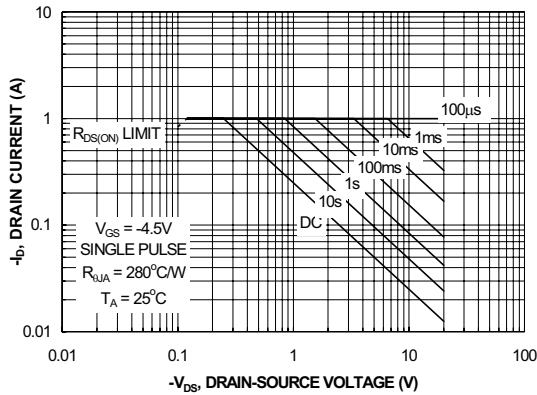

Figure 20. Maximum Safe Operating Area

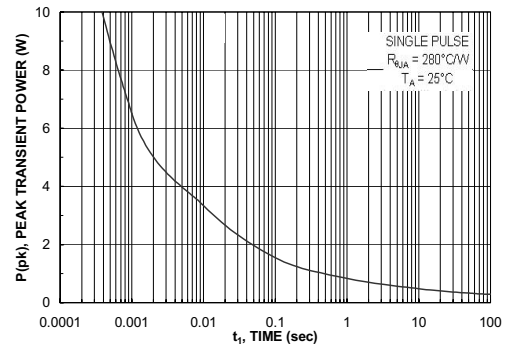

Figure 21. Single Pulse Maximum Power Dissipation

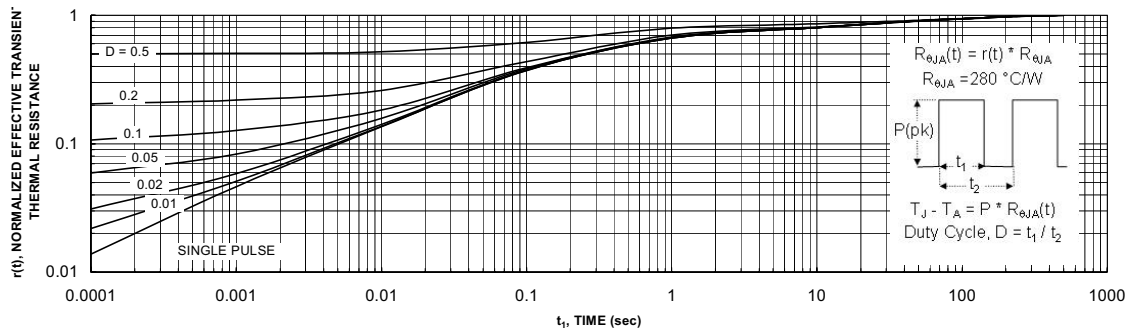
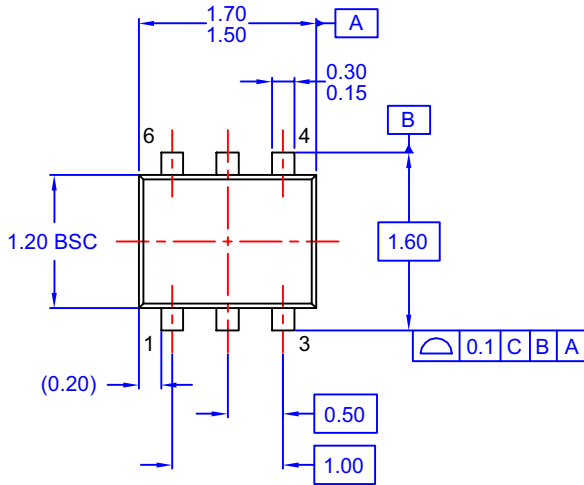
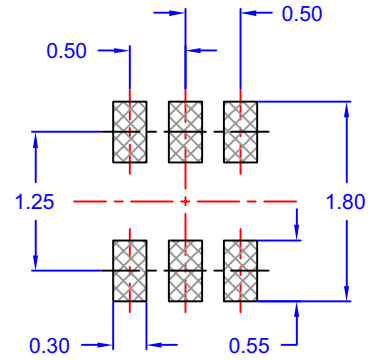

Figure 22. Transient Thermal Response Curve
 Thermal characterization performed using the conditions described in Note 1b.
 Transient thermal response will change depending on the circuit board design.

Dimensional Outline and Pad Layout



TOP VIEW



LAND PATTERN RECOMMENDATION

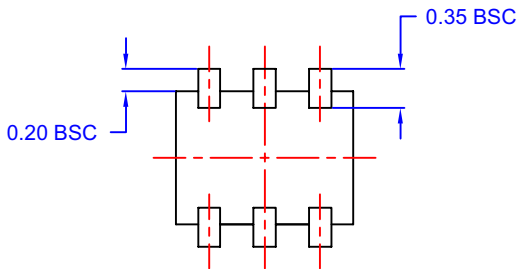
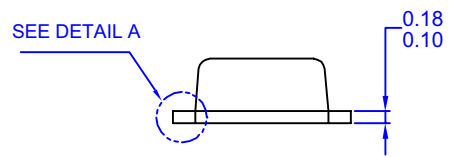
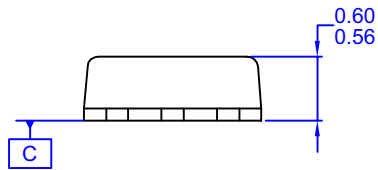

BOTTOM VIEW

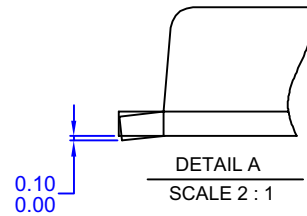

NOTES:





- A) THIS PACKAGE CONFORMS TO EIAJ SC89 PACKAGING STANDARD.
- B) ALL DIMENSIONS ARE IN MILLIMETERS.
- C) DRAWING CONFORMS TO ASME Y14.5M-1994
- D) DIMENSIONS ARE EXCLUSIVE OF BURRS, MOLD FLASH, AND TIE BAR EXTRUSIONS.

MAD06ArevA



TRADEMARKS

The following includes registered and unregistered trademarks and service marks, owned by Fairchild Semiconductor and/or its global subsidiaries, and is not intended to be an exhaustive list of all such trademarks.

- | | | | |
|---|---|--|---|
| AccuPower™ | FPS™ | PowerTrench® | The Power Franchise® |
| Auto-SPM™ | F-PFS™ | PowerXS™ | the power® |
| Build it Now™ | FRFET® | Programmable Active Droop™ | franchise |
| CorePLUS™ | Global Power ResourceSM | QFET® | TinyBoost™ |
| CorePOWER™ | Green FPS™ | QS™ | TinyBuck™ |
| CROSSVOLT™ | Green FPS™ e-Series™ | Quiet Series™ | TinyCalc™ |
| CTL™ | Gmax™ | RapidConfigure™ | TinyLogic® |
| Current Transfer Logic™ | GTO™ |  ™ | TINYOPTO™ |
| EcoSPARK® | IntelliMAX™ | Saving our world, 1mW /W /kW at a time™ | TinyPower™ |
| EfficientMax™ | ISOPLANAR™ | SmartMax™ | TinyPWM™ |
| EZSWITCH™* | MegaBuck™ | SMART START™ | TinyWire™ |
|  ™ | MICROCOUPLER™ | SPM® | TriFault Detect™* |
|  ™ | MicroFET™ | STEALTH™ | TRUECURRENT™* |
| Fairchild® | MicroPak™ | SuperFET™ |  ™ |
| Fairchild Semiconductor® | MillerDrive™ | SuperSOT™-3 | UHC® |
| FACT Quiet Series™ | MotionMax™ | SuperSOT™-6 | Ultra FRFET™ |
| FACT® | Motion-SPM™ | SuperSOT™-8 | UniFET™ |
| FAST® | OPTOLOGIC® | SupreMOS™ | VCX™ |
| FastvCore™ | OPTOPLANAR® | SyncFET™ | VisualMax™ |
| FETBench™ |  ™ | Sync-Lock™ | XS™ |
| FlashWriter®* | PDP SPM™ |  ™* | |
| | Power-SPM™ | | |

*Trademarks of System General Corporation, used under license by Fairchild Semiconductor.

DISCLAIMER

FAIRCHILD SEMICONDUCTOR RESERVES THE RIGHT TO MAKE CHANGES WITHOUT FURTHER NOTICE TO ANY PRODUCTS HEREIN TO IMPROVE RELIABILITY, FUNCTION, OR DESIGN. FAIRCHILD DOES NOT ASSUME ANY LIABILITY ARISING OUT OF THE APPLICATION OR USE OF ANY PRODUCT OR CIRCUIT DESCRIBED HEREIN; NEITHER DOES IT CONVEY ANY LICENSE UNDER ITS PATENT RIGHTS, NOR THE RIGHTS OF OTHERS. THESE SPECIFICATIONS DO NOT EXPAND THE TERMS OF FAIRCHILD'S WORLDWIDE TERMS AND CONDITIONS, SPECIFICALLY THE WARRANTY THEREIN, WHICH COVERS THESE PRODUCTS.

LIFE SUPPORT POLICY

FAIRCHILD'S PRODUCTS ARE NOT AUTHORIZED FOR USE AS CRITICAL COMPONENTS IN LIFE SUPPORT DEVICES OR SYSTEMS WITHOUT THE EXPRESS WRITTEN APPROVAL OF FAIRCHILD SEMICONDUCTOR CORPORATION.

As used herein:

1. Life support devices or systems are devices or systems which, (a) are intended for surgical implant into the body or (b) support or sustain life, and (c) whose failure to perform when properly used in accordance with instructions for use provided in the labeling, can be reasonably expected to result in a significant injury of the user.
2. A critical component in any component of a life support, device, or system whose failure to perform can be reasonably expected to cause the failure of the life support device or system, or to affect its safety or effectiveness.

ANTI-COUNTERFEITING POLICY

Fairchild Semiconductor Corporation's Anti-Counterfeiting Policy. Fairchild's Anti-Counterfeiting Policy is also stated on our external website, www.Fairchildsemi.com, under Sales Support.

Counterfeiting of semiconductor parts is a growing problem in the industry. All manufactures of semiconductor products are experiencing counterfeiting of their parts. Customers who inadvertently purchase counterfeit parts experience many problems such as loss of brand reputation, substandard performance, failed application, and increased cost of production and manufacturing delays. Fairchild is taking strong measures to protect ourselves and our customers from the proliferation of counterfeit parts. Fairchild strongly encourages customers to purchase Fairchild parts either directly from Fairchild or from Authorized Fairchild Distributors who are listed by country on our web page cited above. Products customers buy either from Fairchild directly or from Authorized Fairchild Distributors are genuine parts, have full traceability, meet Fairchild's quality standards for handling and storage and provide access to Fairchild's full range of up-to-date technical and product information. Fairchild and our Authorized Distributors will stand behind all warranties and will appropriately address and warranty issues that may arise. Fairchild will not provide any warranty coverage or other assistance for parts bought from Unauthorized Sources. Fairchild is committed to combat this global problem and encourage our customers to do their part in stopping this practice by buying direct or from authorized distributors.

PRODUCT STATUS DEFINITIONS

Definition of Terms

Datasheet Identification	Product Status	Definition
Advance Information	Formative / In Design	Datasheet contains the design specifications for product development. Specifications may change in any manner without notice.
Preliminary	First Production	Datasheet contains preliminary data; supplementary data will be published at a later date. Fairchild Semiconductor reserves the right to make changes at any time without notice to improve design.
No Identification Needed	Full Production	Datasheet contains final specifications. Fairchild Semiconductor reserves the right to make changes at any time without notice to improve the design.
Obsolete	Not In Production	Datasheet contains specifications on a product that is discontinued by Fairchild Semiconductor. The datasheet is for reference information only.

Rev. 141

ON Semiconductor and  are trademarks of Semiconductor Components Industries, LLC dba ON Semiconductor or its subsidiaries in the United States and/or other countries. ON Semiconductor owns the rights to a number of patents, trademarks, copyrights, trade secrets, and other intellectual property. A listing of ON Semiconductor's product/patent coverage may be accessed at www.onsemi.com/site/pdf/Patent-Marking.pdf. ON Semiconductor reserves the right to make changes without further notice to any products herein. ON Semiconductor makes no warranty, representation or guarantee regarding the suitability of its products for any particular purpose, nor does ON Semiconductor assume any liability arising out of the application or use of any product or circuit, and specifically disclaims any and all liability, including without limitation special, consequential or incidental damages. Buyer is responsible for its products and applications using ON Semiconductor products, including compliance with all laws, regulations and safety requirements or standards, regardless of any support or applications information provided by ON Semiconductor. "Typical" parameters which may be provided in ON Semiconductor data sheets and/or specifications can and do vary in different applications and actual performance may vary over time. All operating parameters, including "Typicals" must be validated for each customer application by customer's technical experts. ON Semiconductor does not convey any license under its patent rights nor the rights of others. ON Semiconductor products are not designed, intended, or authorized for use as a critical component in life support systems or any FDA Class 3 medical devices or medical devices with a same or similar classification in a foreign jurisdiction or any devices intended for implantation in the human body. Should Buyer purchase or use ON Semiconductor products for any such unintended or unauthorized application, Buyer shall indemnify and hold ON Semiconductor and its officers, employees, subsidiaries, affiliates, and distributors harmless against all claims, costs, damages, and expenses, and reasonable attorney fees arising out of, directly or indirectly, any claim of personal injury or death associated with such unintended or unauthorized use, even if such claim alleges that ON Semiconductor was negligent regarding the design or manufacture of the part. ON Semiconductor is an Equal Opportunity/Affirmative Action Employer. This literature is subject to all applicable copyright laws and is not for resale in any manner.

PUBLICATION ORDERING INFORMATION

LITERATURE FULFILLMENT:

Literature Distribution Center for ON Semiconductor
19521 E. 32nd Pkwy, Aurora, Colorado 80011 USA
Phone: 303-675-2175 or 800-344-3860 Toll Free USA/Canada
Fax: 303-675-2176 or 800-344-3867 Toll Free USA/Canada
Email: orderlit@onsemi.com

N. American Technical Support: 800-282-9855 Toll Free
USA/Canada
Europe, Middle East and Africa Technical Support:
Phone: 421 33 790 2910
Japan Customer Focus Center
Phone: 81-3-5817-1050

ON Semiconductor Website: www.onsemi.com
Order Literature: <http://www.onsemi.com/orderlit>
For additional information, please contact your local
Sales Representative