

MOSFET – P-Channel, POWERTRENCH[®], Common Drain: 1.5 V, WLCSP -20 V, -3 A, 126 mΩ



ON Semiconductor[®]

www.onsemi.com

FDZ1905PZ

General Description

This device is designed specifically as a single package solution for the battery charge switch in cellular handset and other ultra-portable applications. It features two common drain P-channel MOSFETs, which enables bidirectional current flow, on ON Semiconductor's advanced 1.5 V POWERTRENCH process with state of the art "low pitch" WLCSP packaging process, the FDZ1905PZ minimizes both PCB space and $r_{S1S2(on)}$. This advanced WLCSP MOSFET embodies a breakthrough in packaging technology which enables the device to combine excellent thermal transfer characteristics, ultra-low profile packaging, low gate charge, and low $r_{S1S2(on)}$.

Features

- Max $r_{S1S2(on)}$ = 126 mΩ at $V_{GS} = -4.5$ V, $I_{S1S2} = -1$ A
- Max $r_{S1S2(on)}$ = 141 mΩ at $V_{GS} = -2.5$ V, $I_{S1S2} = -1$ A
- Max $r_{S1S2(on)}$ = 198 mΩ at $V_{GS} = -1.8$ V, $I_{S1S2} = -1$ A
- Max $r_{S1S2(on)}$ = 303 mΩ at $V_{GS} = -1.5$ V, $I_{S1S2} = -1$ A
- Occupies only 1.5 mm² of PCB area, less than 50% of the area of 2 x 2 BGA
- Ultra-thin package: less than 0.65 mm height when mounted to PCB
- High power and current handling capability
- HBM ESD protection level > 4 kV (Note 3)
- This Device is Pb-Free and is RoHS Compliant

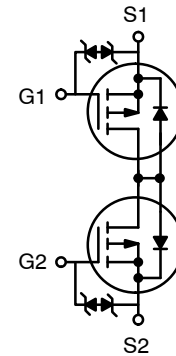

P-Channel MOSFET

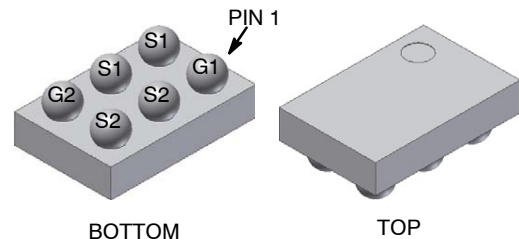

BOTTOM

TOP

WLCSP6 1.5x1x0.6
CASE 567PW

MARKING DIAGRAM

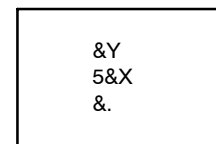

- 5 = Specific Device Code
- &Y = Year Date Code
- &X = Weekly Date Code
- & = Pin Mark

ORDERING INFORMATION

See detailed ordering and shipping information on page 6 of this data sheet.

FDZ1905PZ

MOSFET MAXIMUM RATINGS ($T_A = 25^\circ\text{C}$ unless otherwise specified)

Symbol	Parameter	Rating	Unit
V_{S1S2}	Source1 to Source2 Voltage	-20	V
V_{GS}	Gate to Source Voltage	± 8	V
I_{S1S2}	Source1 to Source2 Current	- Continuous, $T_A = 25^\circ\text{C}$ (Note 1a)	-3
		- Pulsed	-15
P_D	Power Dissipation (Steady State)	$T_A = 25^\circ\text{C}$ (Note 1a)	1.5
	Power Dissipation	$T_A = 25^\circ\text{C}$ (Note 1b)	0.9
T_J, T_{STG}	Operating and Storage Junction Temperature Range	-55 to +150	$^\circ\text{C}$

Stresses exceeding those listed in the Maximum Ratings table may damage the device. If any of these limits are exceeded, device functionality should not be assumed, damage may occur and reliability may be affected.

THERMAL CHARACTERISTICS

Symbol	Parameter	Rating	Unit
$R_{\theta JA}$	Thermal Resistance, Junction to Ambient (Note 1a)	83	$^\circ\text{C}/\text{W}$
$R_{\theta JA}$	Thermal Resistance, Junction to Ambient (Note 1b)	140	

ELECTRICAL CHARACTERISTICS ($T_J = 25^\circ\text{C}$ unless otherwise noted)

Symbol	Parameter	Test Condition	Min.	Typ.	Max.	Unit
--------	-----------	----------------	------	------	------	------

OFF CHARACTERISTICS

I_{S1S2}	Zero Gate Voltage Source1 to Source2 Current	$V_{S1S2} = -16\text{ V}, V_{GS} = 0\text{ V}$	-	-	-1	μA
I_{GSS}	Gate Body Leakage Current	$V_{GS} = \pm 8\text{ V}, V_{S1S2} = 0\text{ V}$	-	-	± 10	μA

ON CHARACTERISTICS (Note 2)

$V_{GS(th)}$	Gate to Source Threshold Voltage	$V_{GS} = V_{S1S2}, I_{S1S2} = -250\text{ mA}$	-0.4	-0.7	-1.0	V
$r_{S1S2(on)}$	Static Source1 to Source2 On Resistance	$V_{GS} = -4.5\text{ V}, I_{S1S2} = -1\text{ A}$	-	99	126	$\text{m}\Omega$
		$V_{GS} = -2.5\text{ V}, I_{S1S2} = -1\text{ A}$	-	112	141	
		$V_{GS} = -1.8\text{ V}, I_{S1S2} = -1\text{ A}$	-	132	198	
		$V_{GS} = -1.5\text{ V}, I_{S1S2} = -1\text{ A}$	-	164	303	
		$V_{GS} = -4.5\text{ V}, I_{S1S2} = -1\text{ A}, T_J = 125^\circ\text{C}$	-	135	195	
g_{FS}	Forward Transconductance	$V_{S1S2} = -5\text{ V}, I_{S1S2} = -1\text{ A}$	-	8	-	S

SWITCHING CHARACTERISTICS (Note 2)

$t_{d(on)}$	Turn-On Delay Time	$V_{S1S2} = -10\text{ V}, I_{S1S2} = -1\text{ A}$ $V_{GS} = -4.5\text{ V}, R_{GEN} = 6\ \Omega$	-	12	22	ns
t_r	Rise Time		-	36	58	ns
$t_{d(off)}$	Turn-Off Delay Time		-	143	229	ns
t_f	Fall Time		-	182	291	ns

Product parametric performance is indicated in the Electrical Characteristics for the listed test conditions, unless otherwise noted. Product performance may not be indicated by the Electrical Characteristics if operated under different conditions.

FDZ1905PZ

NOTES:

1. $R_{\theta JA}$ is determined with the device mounted on a 1 in^2 pad of 2 oz copper on a 1.5×1.5 in. board of FR-4 material. $R_{\theta JC}$ is guaranteed by design while $R_{\theta CA}$ is determined by the user's board design.



a. 83°C/W when mounted on a 1 in^2 pad of 2 oz copper



b. 0°C/W when mounted on a minimum pad of 2 oz copper

2. Pulse Test: Pulse Width < 300 ms, Duty cycle $< 2.0\%$.
3. The diode connected between the gate and source serves only protection against ESD. No gate overvoltage rating is implied.

TYPICAL CHARACTERISTICS ($T_J = 25^\circ\text{C}$ unless otherwise noted)

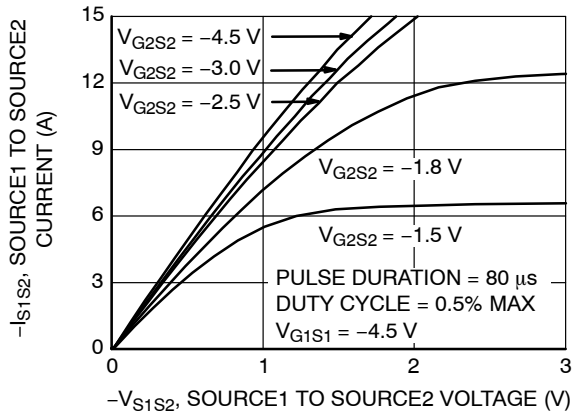

Figure 1. On Region Characteristics

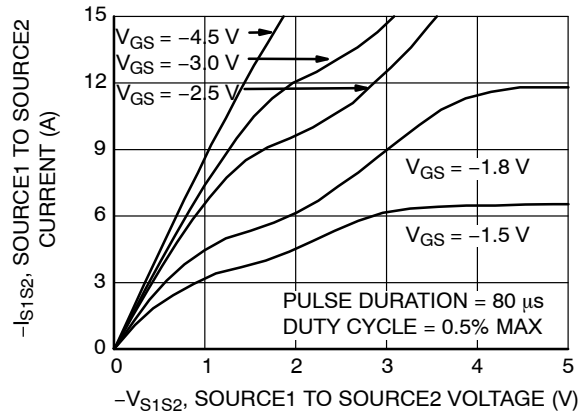

Figure 2. On Region Characteristics

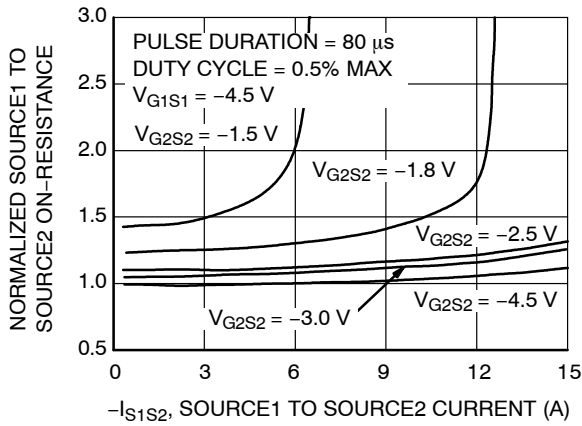

Figure 3. Normalized On-Resistance vs Drain Current and Gate Voltage

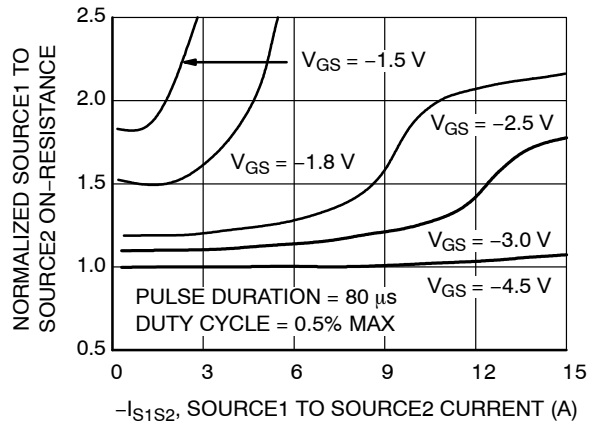

Figure 4. Normalized On-Resistance vs Drain Current and Gate Voltage

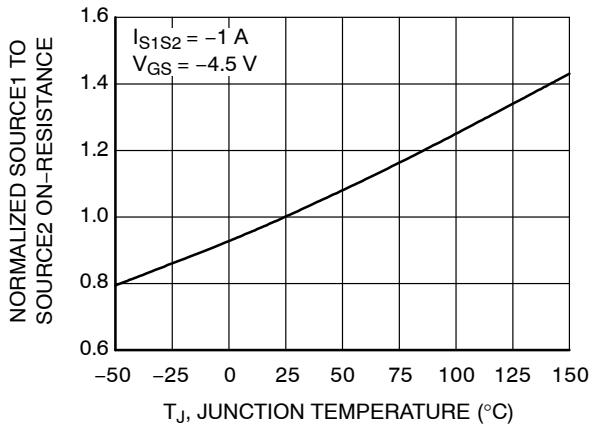

Figure 5. Normalized On-Resistance vs Junction Temperature

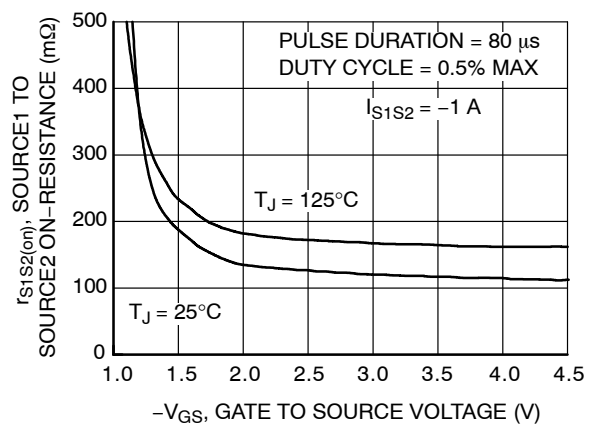

Figure 6. On-Resistance vs Gate to Source Voltage

TYPICAL CHARACTERISTICS ($T_J = 25^\circ\text{C}$ unless otherwise noted)

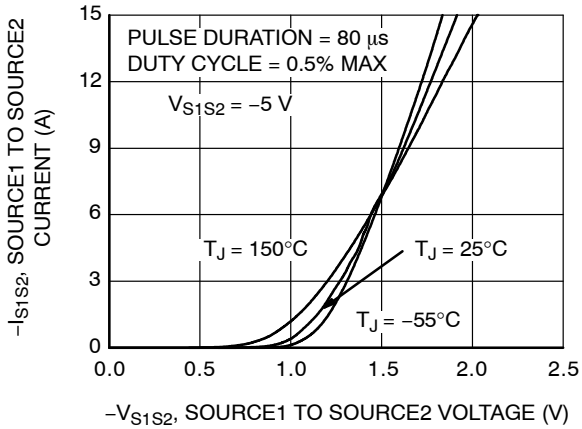

Figure 7. Transfer Characteristics

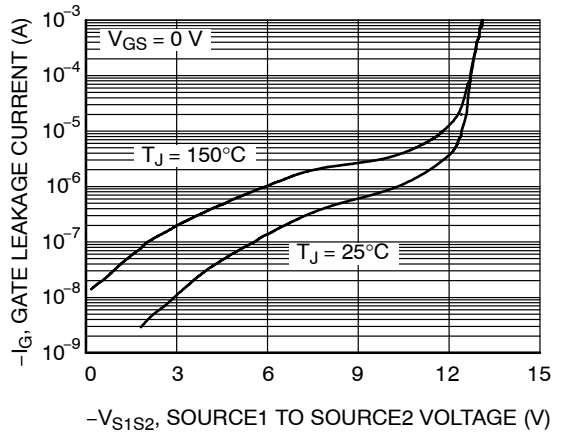

Figure 8. Gate Leakage vs Gate to Source Voltage

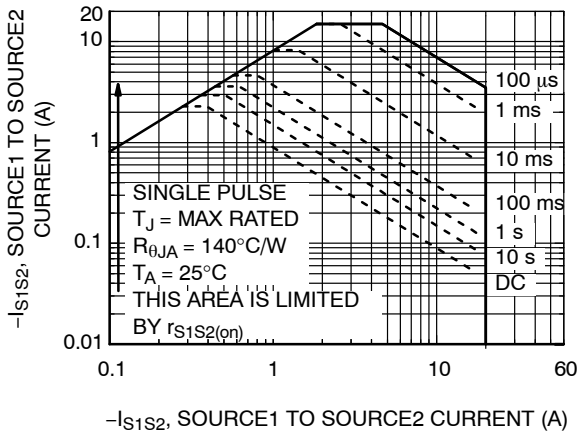

Figure 9. Forward Bias Safe Operating Area

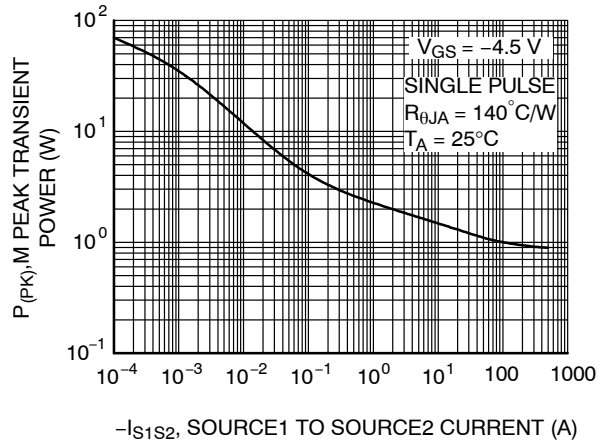

Figure 10. Single Pulse Maximum Power Dissipation

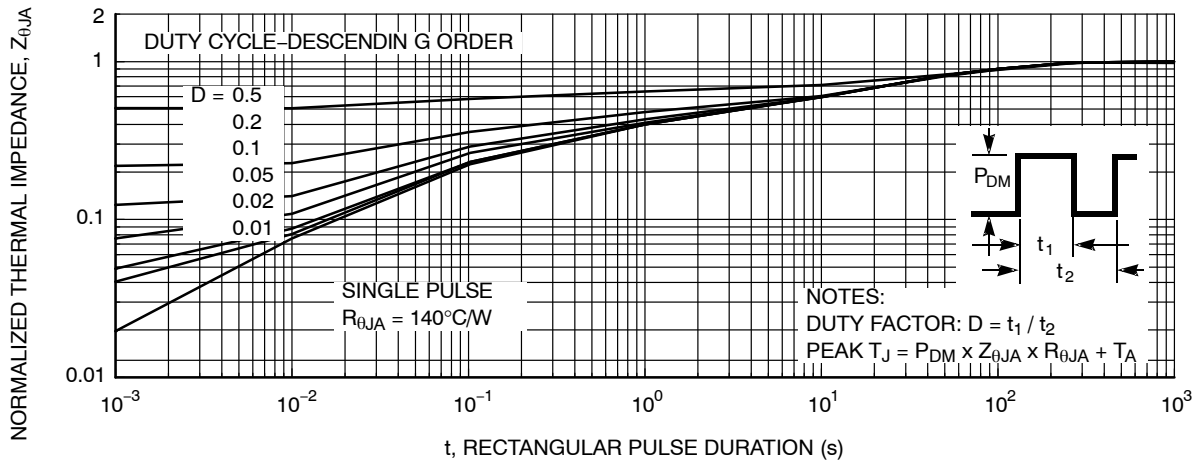

Figure 11. Transient Thermal Response Curve

FDZ1905PZ

ORDERING INFORMATION

Device	Device Marking	Package	Reel Size	Tape Width	Shipping†
FDZ1905PZ	5	WLCSP6 1.5x1x0.6 (Pb-Free)	7"	8 mm	5000 / Tape & Reel

†For information on tape and reel specifications, including part orientation and tape sizes, please refer to our Tape and Reel Packaging Specifications Brochure, BRD8011/D.

POWERTRENCH is registered trademark of Semiconductor Components Industries, LLC (SCILLC) or its subsidiaries in the United States and/or other countries.

MECHANICAL CASE OUTLINE

PACKAGE DIMENSIONS

ON Semiconductor®

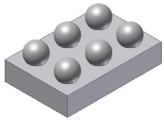

WLCSP6 1.5x1x0.6
CASE 567PW
ISSUE A

DATE 04 AUG 2021

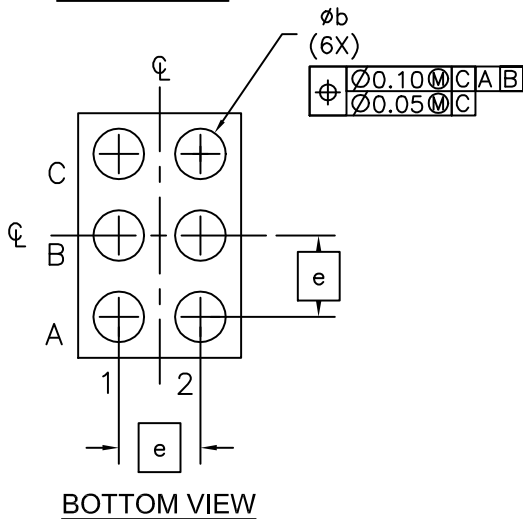
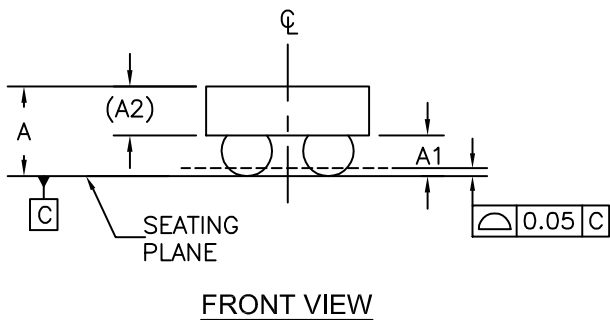
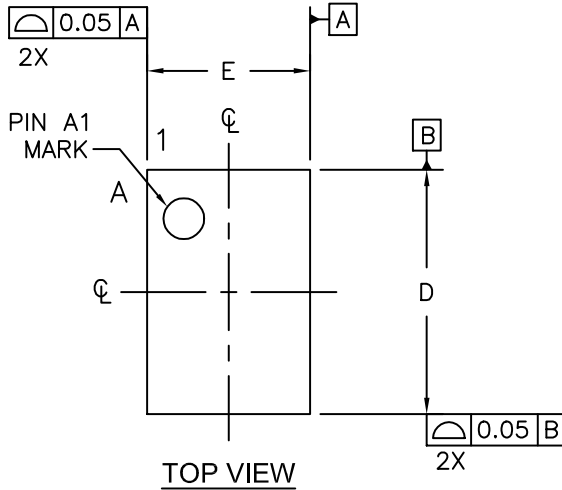

NOTES: UNLESS OTHERWISE SPECIFIED

- A) ALL DIMENSIONS ARE IN MILLIMETERS.
- B) NO JEDEC REGISTRATION REFERENCE AS OF OCTOBER 2005.
- C) DRAWING CONFORMS TO ASME Y14.5M-2009

DIM	MILLIMETERS		
	MIN.	NOM.	MAX.
A	-	-	0.60
A1	0.22	0.25	0.28
A2	0.30 REF		
b	0.24	0.31	0.39
D	1.45	1.50	1.55
E	0.95	1.00	1.05
e	0.50 BSC		

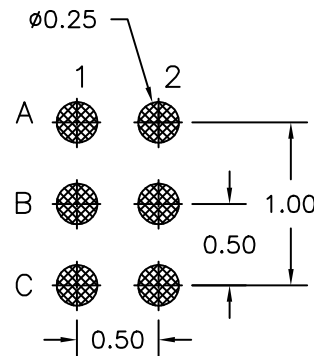

*FOR ADDITIONAL INFORMATION ON OUR PB-FREE STRATEGY AND SOLDERING DETAILS, PLEASE DOWNLOAD THE ON SEMICONDUCTOR SOLDERING AND MOUNTING TECHNIQUES REFERENCE MANUAL, SOLDERRM/D.

DOCUMENT NUMBER:	98AON13306G	Electronic versions are uncontrolled except when accessed directly from the Document Repository. Printed versions are uncontrolled except when stamped "CONTROLLED COPY" in red.
DESCRIPTION:	WLCSP6 1.5x1x0.6	PAGE 1 OF 1

ON Semiconductor and are trademarks of Semiconductor Components Industries, LLC dba ON Semiconductor or its subsidiaries in the United States and/or other countries. ON Semiconductor reserves the right to make changes without further notice to any products herein. ON Semiconductor makes no warranty, representation or guarantee regarding the suitability of its products for any particular purpose, nor does ON Semiconductor assume any liability arising out of the application or use of any product or circuit, and specifically disclaims any and all liability, including without limitation special, consequential or incidental damages. ON Semiconductor does not convey any license under its patent rights nor the rights of others.

onsemi, **Onsemi**, and other names, marks, and brands are registered and/or common law trademarks of Semiconductor Components Industries, LLC dba "**onsemi**" or its affiliates and/or subsidiaries in the United States and/or other countries. **onsemi** owns the rights to a number of patents, trademarks, copyrights, trade secrets, and other intellectual property. A listing of **onsemi**'s product/patent coverage may be accessed at www.onsemi.com/site/pdf/Patent-Marking.pdf. **onsemi** reserves the right to make changes at any time to any products or information herein, without notice. The information herein is provided "as-is" and **onsemi** makes no warranty, representation or guarantee regarding the accuracy of the information, product features, availability, functionality, or suitability of its products for any particular purpose, nor does **onsemi** assume any liability arising out of the application or use of any product or circuit, and specifically disclaims any and all liability, including without limitation special, consequential or incidental damages. Buyer is responsible for its products and applications using **onsemi** products, including compliance with all laws, regulations and safety requirements or standards, regardless of any support or applications information provided by **onsemi**. "Typical" parameters which may be provided in **onsemi** data sheets and/or specifications can and do vary in different applications and actual performance may vary over time. All operating parameters, including "Typicals" must be validated for each customer application by customer's technical experts. **onsemi** does not convey any license under any of its intellectual property rights nor the rights of others. **onsemi** products are not designed, intended, or authorized for use as a critical component in life support systems or any FDA Class 3 medical devices or medical devices with a same or similar classification in a foreign jurisdiction or any devices intended for implantation in the human body. Should Buyer purchase or use **onsemi** products for any such unintended or unauthorized application, Buyer shall indemnify and hold **onsemi** and its officers, employees, subsidiaries, affiliates, and distributors harmless against all claims, costs, damages, and expenses, and reasonable attorney fees arising out of, directly or indirectly, any claim of personal injury or death associated with such unintended or unauthorized use, even if such claim alleges that **onsemi** was negligent regarding the design or manufacture of the part. **onsemi** is an Equal Opportunity/Affirmative Action Employer. This literature is subject to all applicable copyright laws and is not for resale in any manner.

ADDITIONAL INFORMATION

TECHNICAL PUBLICATIONS:

Technical Library: www.onsemi.com/design/resources/technical-documentation
onsemi Website: www.onsemi.com

ONLINE SUPPORT: www.onsemi.com/support

For additional information, please contact your local Sales Representative at www.onsemi.com/support/sales