

Silicon Carbide (SiC) Schottky Diode – EliteSiC, 8 A, 650 V, D1, DPAK

FFSD0865A

Description

Silicon Carbide (SiC) Schottky Diodes use a completely new technology that provides superior switching performance and higher reliability compared to Silicon. No reverse recovery current, temperature independent switching characteristics, and excellent thermal performance sets Silicon Carbide as the next generation of power semiconductor. System benefits include highest efficiency, faster operating frequency, increased power density, reduced EMI, and reduced system size and cost.

Features

- Max Junction Temperature 175°C
- Avalanche Rated 49 mJ
- High Surge Current Capacity
- Positive Temperature Coefficient
- Ease of Paralleling
- No Reverse Recovery/No Forward Recovery
- This Device is Pb-Free, Halogen Free/BFR Free and RoHS Compliant

Applications

- General Purpose
- SMPS, Solar Inverter, UPS
- Power Switching Circuits

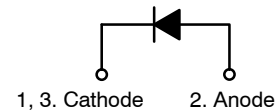

Schottky Diode

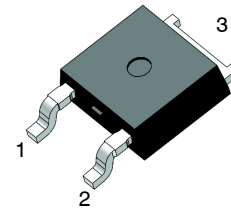

DPAK
 CASE 369AS

MARKING DIAGRAM

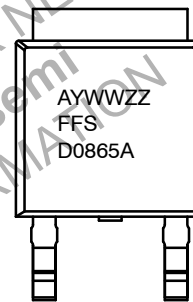

- | | |
|-----------|---------------------------|
| A | = Assembly Plant Code |
| YWW | = Date Code (Year & Week) |
| ZZ | = Lot Code |
| FFSD0865A | = Specific Device Code |

ORDERING INFORMATION

See detailed ordering and shipping information in the package dimensions section on page 2 of this data sheet.

FFSD0865A

Table 1. ABSOLUTE MAXIMUM RATINGS ($T_C = 25^\circ\text{C}$ unless otherwise noted)

Symbol	Parameter	FFSD0865A	Unit	
V_{RRM}	Peak Repetitive Reverse Voltage	650	V	
E_{AS}	Single Pulse Avalanche Energy (Note 1)	49	mJ	
I_F	Continuous Rectified Forward Current @ $T_C < 159^\circ\text{C}$	8	A	
	Continuous Rectified Forward Current @ $T_C < 135^\circ\text{C}$	15		
$I_{F,Max}$	Non-Repetitive Peak Forward Surge Current	$T_C = 25^\circ\text{C}$, 10 μs	750	A
		$T_C = 150^\circ\text{C}$, 10 μs	730	A
$I_{F,SM}$	Non-Repetitive Forward Surge Current	Half-Sine Pulse, $t_p = 8.3$ ms	49	A
$I_{F,RM}$	Repetitive Forward Surge Current	Half-Sine Pulse, $t_p = 8.3$ ms	28	A
P_{tot}	Power Dissipation	$T_C = 25^\circ\text{C}$	125	W
		$T_C = 150^\circ\text{C}$	21	W
T_J, T_{STG}	Operating and Storage Temperature Range	-55 to +175	$^\circ\text{C}$	

Stresses exceeding those listed in the Maximum Ratings table may damage the device. If any of these limits are exceeded, device functionality should not be assumed, damage may occur and reliability may be affected.

1. E_{AS} of 49 mJ is based on starting $T_J = 25^\circ\text{C}$, $L = 0.5$ mH, $I_{AS} = 14$ A, $V = 50$ V.

Table 2. THERMAL CHARACTERISTICS

Symbol	Parameter	Rating	Unit
$R_{\theta JC}$	Thermal Resistance, Junction-to-Case, Max.	1.2	$^\circ\text{C}/\text{W}$

Table 3. OPERATING CHARACTERISTICS ($T_C = 25^\circ\text{C}$, unless otherwise noted)

Symbol	Parameter	Test Conditions	Min	Typ	Max	Unit
V_F	Forward Voltage	$I_F = 8$ A, $T_C = 25^\circ\text{C}$	-	1.50	1.75	V
		$I_F = 8$ A, $T_C = 125^\circ\text{C}$	-	1.6	2.0	
		$I_F = 8$ A, $T_C = 175^\circ\text{C}$	-	1.72	2.4	
I_R	Reverse Current	$V_R = 650$ V, $T_C = 25^\circ\text{C}$	-	-	200	μA
		$V_R = 650$ V, $T_C = 125^\circ\text{C}$	-	-	400	
		$V_R = 650$ V, $T_C = 175^\circ\text{C}$	-	-	600	
Q_C	Total Capacitive Charge	$V = 400$ V	-	27	-	nC
C	Total Capacitance	$V_R = 1$ V, $f = 100$ kHz	-	463	-	pF
		$V_R = 200$ V, $f = 100$ kHz	-	48	-	
		$V_R = 400$ V, $f = 100$ kHz	-	38	-	

Product parametric performance is indicated in the Electrical Characteristics for the listed test conditions, unless otherwise noted. Product performance may not be indicated by the Electrical Characteristics if operated under different conditions.

PART MARKING AND ORDERING INFORMATION

Part Number	Top Mark	Package	Packing Method	Reel Size [†]	Tape Width	Quantity
FFSD0865A	FFSD0865A	DPAK	N/A	13"	N/A	2500 units

[†]For information on tape and reel specifications, including part orientation and tape sizes, please refer to our Tape and Reel Packaging Specifications Brochure, BRD8011/D

TYPICAL CHARACTERISTICS

($T_J = 25^\circ\text{C}$ UNLESS OTHERWISE NOTED)

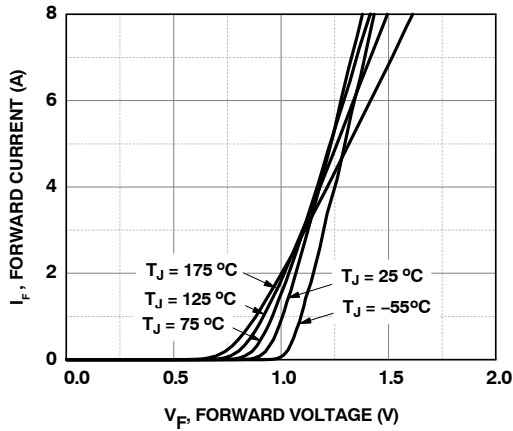

Figure 1. Forward Characteristics

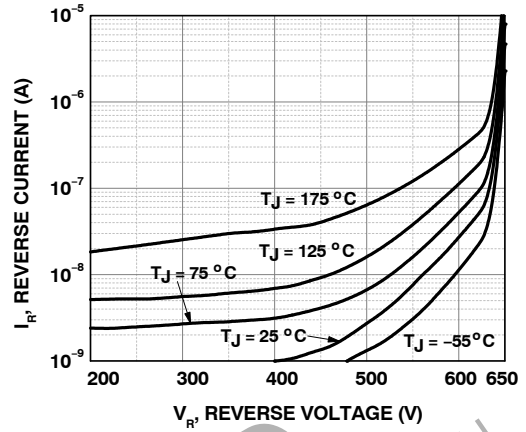

Figure 2. Reverse Characteristics

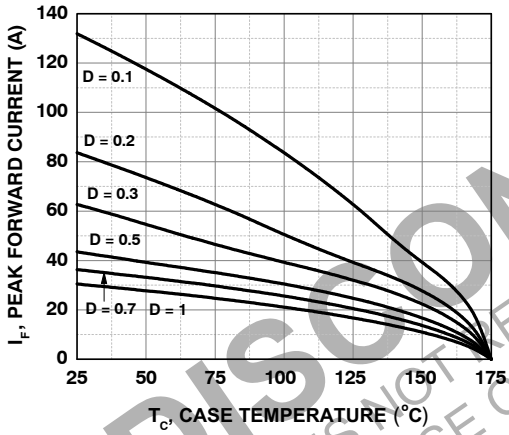

Figure 3. Current Derating

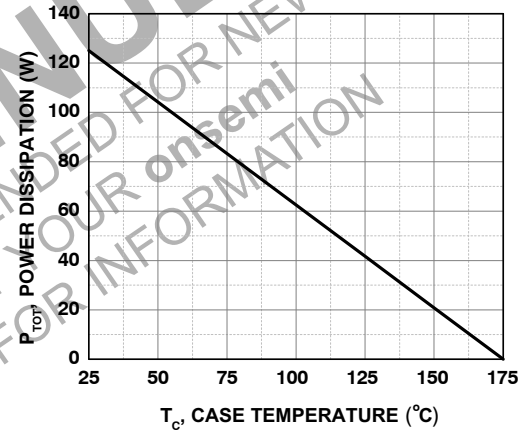

Figure 4. Power Derating

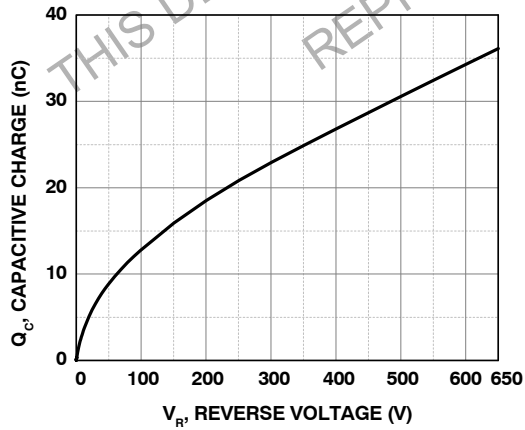

Figure 5. Capacitive Charge vs. Reverse Voltage

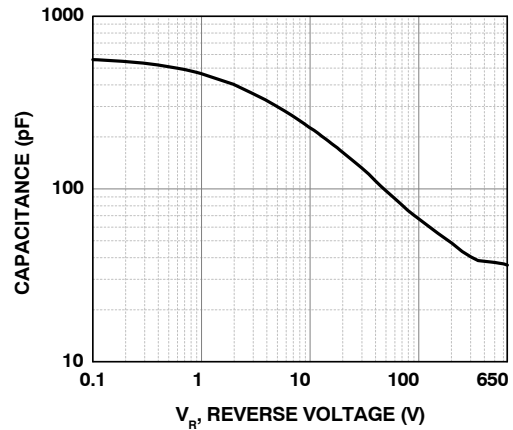

Figure 6. Capacitance vs. Reverse Voltage

TYPICAL CHARACTERISTICS (CONTINUED)

(T_J = 25°C UNLESS OTHERWISE NOTED)

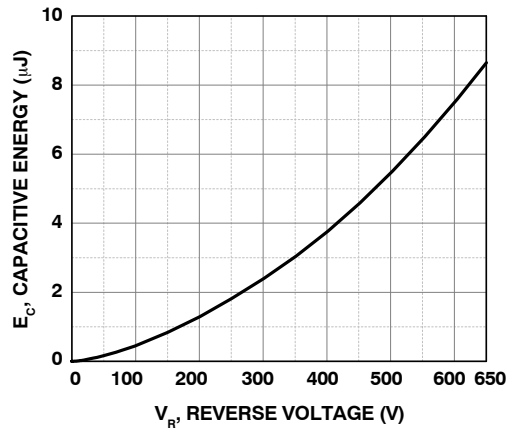

Figure 7. Capacitance Stored Energy

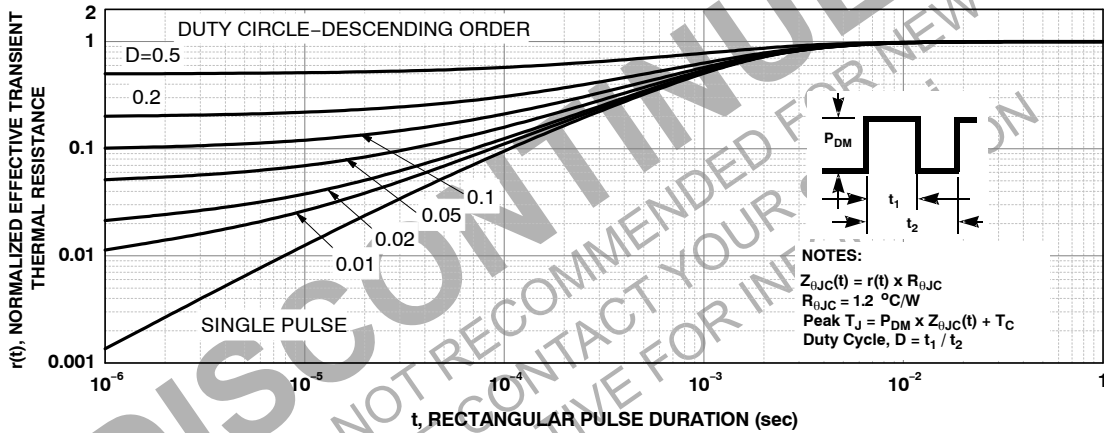

Figure 8. Junction-to-Case Transient Thermal Response Curve

TEST CIRCUIT AND WAVEFORMS

- L = 0.5 mH
- R < 0.1 Ω
- V_{DD} = 50 V
- EAVL = 1/2LI² [V_{R(AVL)} / (V_{R(AVL)} - V_{DD})]
- Q1 = IGBT (BV_{CES} > DUT V_{R(AVL)})

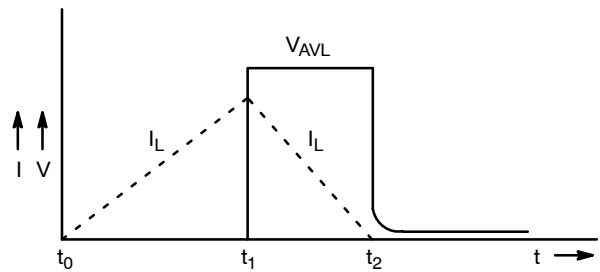
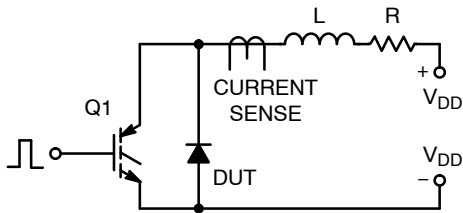
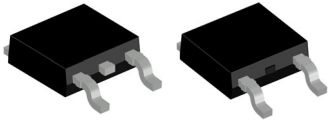
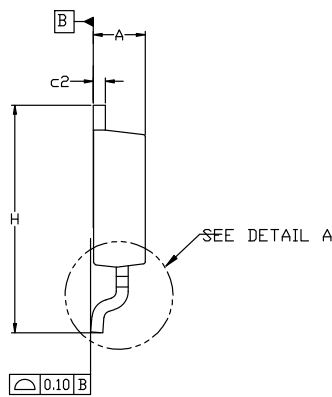
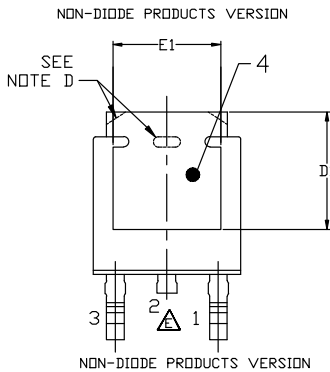
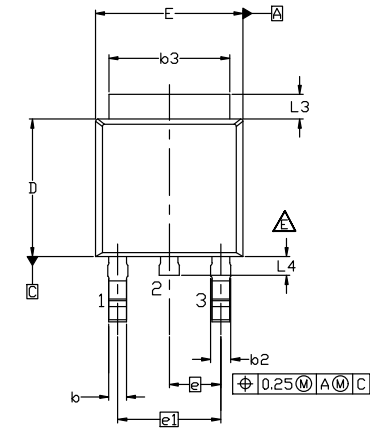

Figure 9. Unclamped Inductive Switching Test Circuit & Waveform



**DPAK3 6.10x6.54x2.29, 4.57P
CASE 369AS
ISSUE B**

DATE 20 DEC 2023



- NOTES: UNLESS OTHERWISE SPECIFIED
 A) THIS PACKAGE CONFORMS TO JEDEC, TO-252, ISSUE F, VARIATION AA.
 B) ALL DIMENSIONS ARE IN MILLIMETERS.
 C) DIMENSIONING AND TOLERANCING PER ASME Y14.5M-2018.
 D) SUPPLIER DEPENDENT MOLD LOCKING HOLES OR CHAMFERED CORNERS OR EDGE PROTRUSION.
 E) FOR DIODE PRODUCTS, L4 IS 0.25 MM MAX PLASTIC BODY STUB WITHOUT CENTER LEAD.
 F) DIMENSIONS ARE EXCLUSIVE OF BURRS, MOLD FLASH AND TIE BAR EXTRUSIONS.
 G) LAND PATTERN RECOMMENDATION IS BASED ON IPC7351A STD TD228P991X239-3N.

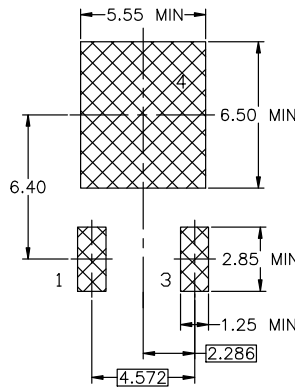
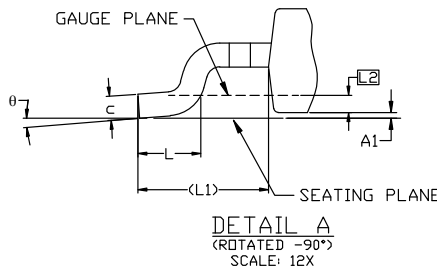

LAND PATTERN RECOMMENDATION

*FOR ADDITIONAL INFORMATION ON OUR Pb-FREE STRATEGY AND SOLDERING DETAILS, PLEASE DOWNLOAD THE ON SEMICONDUCTOR SOLDERING AND MOUNTING TECHNIQUES REFERENCE MANUAL, SOLDERM/D.

DIM	MILLIMETERS		
	MIN.	NOM.	MAX.
A	2.18	2.29	2.39
A1	0.00	-	0.127
b	0.64	0.77	0.89
b2	0.76	0.95	1.14
b3	5.21	5.34	5.46
c	0.45	0.53	0.61
c2	0.45	0.52	0.58
D	5.97	6.10	6.22
D1	5.21	---	---
E	6.35	6.54	6.73
E1	4.32	---	---
e	2.286 BSC		
e1	4.572 BSC		
H	9.40	9.91	10.41
L	1.40	1.59	1.78
L1	2.90 REF		
L2	0.51 BSC		
L3	0.89	1.08	1.27
L4	---	---	1.02
θ	0°	---	10°

GENERIC MARKING DIAGRAM*

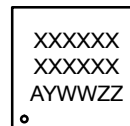

*This information is generic. Please refer to device data sheet for actual part marking. Pb-Free indicator, "G" or microdot "•", may or may not be present. Some products may not follow the Generic Marking.

- XXXX = Specific Device Code
- A = Assembly Location
- Y = Year
- WW = Work Week
- ZZ = Assembly Lot Code

DOCUMENT NUMBER:	98AON13810G	Electronic versions are uncontrolled except when accessed directly from the Document Repository. Printed versions are uncontrolled except when stamped "CONTROLLED COPY" in red.
DESCRIPTION:	DPAK3 6.10x6.54x2.29, 4.57P	PAGE 1 OF 1

onsemi and Onsemi are trademarks of Semiconductor Components Industries, LLC dba onsemi or its subsidiaries in the United States and/or other countries. onsemi reserves the right to make changes without further notice to any products herein. onsemi makes no warranty, representation or guarantee regarding the suitability of its products for any particular purpose, nor does onsemi assume any liability arising out of the application or use of any product or circuit, and specifically disclaims any and all liability, including without limitation special, consequential or incidental damages. onsemi does not convey any license under its patent rights nor the rights of others.

onsemi, **Onsemi**, and other names, marks, and brands are registered and/or common law trademarks of Semiconductor Components Industries, LLC dba "**onsemi**" or its affiliates and/or subsidiaries in the United States and/or other countries. **onsemi** owns the rights to a number of patents, trademarks, copyrights, trade secrets, and other intellectual property. A listing of **onsemi**'s product/patent coverage may be accessed at www.onsemi.com/site/pdf/Patent-Marking.pdf. **onsemi** reserves the right to make changes at any time to any products or information herein, without notice. The information herein is provided "as-is" and **onsemi** makes no warranty, representation or guarantee regarding the accuracy of the information, product features, availability, functionality, or suitability of its products for any particular purpose, nor does **onsemi** assume any liability arising out of the application or use of any product or circuit, and specifically disclaims any and all liability, including without limitation special, consequential or incidental damages. Buyer is responsible for its products and applications using **onsemi** products, including compliance with all laws, regulations and safety requirements or standards, regardless of any support or applications information provided by **onsemi**. "Typical" parameters which may be provided in **onsemi** data sheets and/or specifications can and do vary in different applications and actual performance may vary over time. All operating parameters, including "Typicals" must be validated for each customer application by customer's technical experts. **onsemi** does not convey any license under any of its intellectual property rights nor the rights of others. **onsemi** products are not designed, intended, or authorized for use as a critical component in life support systems or any FDA Class 3 medical devices or medical devices with a same or similar classification in a foreign jurisdiction or any devices intended for implantation in the human body. Should Buyer purchase or use **onsemi** products for any such unintended or unauthorized application, Buyer shall indemnify and hold **onsemi** and its officers, employees, subsidiaries, affiliates, and distributors harmless against all claims, costs, damages, and expenses, and reasonable attorney fees arising out of, directly or indirectly, any claim of personal injury or death associated with such unintended or unauthorized use, even if such claim alleges that **onsemi** was negligent regarding the design or manufacture of the part. **onsemi** is an Equal Opportunity/Affirmative Action Employer. This literature is subject to all applicable copyright laws and is not for resale in any manner.

ADDITIONAL INFORMATION

TECHNICAL PUBLICATIONS:

Technical Library: www.onsemi.com/design/resources/technical-documentation
onsemi Website: www.onsemi.com

ONLINE SUPPORT: www.onsemi.com/support

For additional information, please contact your local Sales Representative at www.onsemi.com/support/sales