

NPT Trench IGBT

1200 V, 25 A

FGA25N120ANTDTU

Description

Using onsemi's proprietary trench design and advanced NPT Technology, the 1200 V NPT IGBT offers superior conduction and switching performances, high avalanche ruggedness and easy parallel operation. This device is well suited for the resonant or soft switching application such as induction heating, microwave oven.

Features

- NPT Trench Technology, Positive Temperature Coefficient
- Low Saturation Voltage: $V_{CE(sat)}$, typ = 2.0 V @ $I_C = 25$ A and $T_C = 25^\circ\text{C}$
- Low Switching Loss: $E_{CE\ off}$, typ = 0.96 mJ @ $I_C = 25$ A and $T_C = 25^\circ\text{C}$
- Extremely Enhanced Avalanche Capability
- This Device is Pb-Free Halide, Free and RoHS Compliant

Applications

- Induction Heating, Microwave Oven

ABSOLUTE MAXIMUM RATINGS

Symbol	Parameter	Value	Unit
V_{CES}	Collector-Emitter Voltage	1200	V
V_{GES}	Gate-Emitter Voltage	± 20	
I_C	Collector Current (@ $T_C = 25^\circ\text{C}$)	50	A
	Collector Current (@ $T_C = 100^\circ\text{C}$)	25	
I_{CM}	Pulsed Collector Current (Note 1)	90	A
I_F	Diode Continuous Forward Current (@ $T_C = 25^\circ\text{C}$)	50	A
	Diode Continuous Forward Current (@ $T_C = 100^\circ\text{C}$)	25	A
I_{FM}	Diode Maximum Forward Current	150	A
P_D	Maximum Power Dissipation (@ $T_C = 25^\circ\text{C}$)	312	W
	Maximum Power Dissipation (@ $T_C = 100^\circ\text{C}$)	125	W
T_J	Operating Temperature Range	-55 to +150	$^\circ\text{C}$
T_{STG}	Storage Temperature Range	-55 to +150	$^\circ\text{C}$
T_L	Maximum Lead Temp for Soldering Purpose, 1/8" from Case for 5 s	300	$^\circ\text{C}$

Stresses exceeding those listed in the Maximum Ratings table may damage the device. If any of these limits are exceeded, device functionality should not be assumed, damage may occur and reliability may be affected.

NOTES:

1. Repetitive Rating: Pulse-width limited by maximum junction temperature.

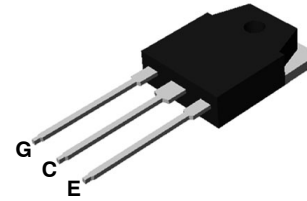

TO-3P-3
CASE 340BZ

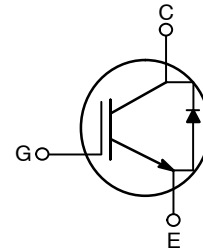

MARKING DIAGRAM

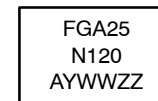

FGA25N120 = Specific Device Code
A = Assembly Location
YWW = Date Code (Year and Week)
ZZ = Assembly Lot Code

ORDERING INFORMATION

See detailed ordering and shipping information on page 2 of this data sheet.

FGA25N120ANTDTU

THERMAL CHARACTERISTICS

Symbol	Parameter	Value	Unit
$R_{\theta JC}$ (IGBT)	Thermal Resistance, Junction to Case	0.4	°C/W
$R_{\theta JC}$ (DIODE)	Thermal Resistance, Junction to Case	2.0	°C/W
$R_{\theta JA}$	Thermal Resistance, Junction to Ambient	40	°C/W

ORDERING INFORMATION

Part Number	Top Mark	Package	Packing Method	Reel Size	Tape Width	Quantity
FGA25N120ANTDTU-F109	FGA25N120ANTD	TO-3PN	Tube	N/A	N/A	30

†For information on tape and reel specifications, including part orientation and tape sizes, please refer to our Tape and Reel Packaging Specifications Brochure, [BRD8011/D](#).

ELECTRICAL CHARACTERISTICS OF THE IGBT ($T_C = 25^\circ\text{C}$ unless otherwise noted)

Symbol	Parameter	Test Conditions	Min	Typ	Max	Unit
--------	-----------	-----------------	-----	-----	-----	------

Off Characteristics

I_{CES}	Collector Cut-Off Current	$V_{CE} = V_{CES}, V_{GE} = 0\text{ V}$	-	-	3	mA
I_{GES}	G-E Leakage Current	$V_{GE} = V_{GES}, V_{CE} = 0\text{ V}$	-	-	±250	nA

On Characteristics

$V_{GE(th)}$	G-E Threshold Voltage	$I_C = 25\text{ mA}, V_{CE} = V_{GE}$	3.5	5.5	7.5	V
$V_{CE(Sat)}$	Collector to Emitter Saturation Voltage	$I_C = 25\text{ A}, V_{GE} = 15\text{ V}$	-	2.0	-	V
		$I_C = 25\text{ A}, V_{GE} = 15\text{ V}, T_C = 125^\circ\text{C}$	-	2.15	-	V
		$I_C = 50\text{ A}, V_{GE} = 15\text{ V}$	-	2.65	-	V

Dynamic Characteristics

C_{ies}	Input Capacitance	$V_{CE} = 30\text{ V}, V_{GE} = 0\text{ V}, f = 1\text{ MHz}$	-	3700	-	pF
C_{oes}	Output Capacitance		-	130	-	pF
C_{res}	Reverse Transfer Capacitance		-	80	-	pF

Switching Characteristics

$t_{d(on)}$	Turn-On Delay Time	$V_{CC} = 600\text{ V}, I_C = 25\text{ A}, R_G = 10\ \Omega, V_{GE} = 15\text{ V},$ Inductive Load, $T_C = 125^\circ\text{C}$	-	50		ns
t_r	Rise Time		-	60		ns
$t_{d(off)}$	Turn-Off Delay Time		-	190		ns
t_f	Fall Time		-	100		ns
E_{on}	Turn-On Switching Loss		-	4.1		mJ
E_{off}	Turn-Off Switching Loss		-	0.96		mJ
E_{ts}	Total Switching Loss		-	5.06		mJ
$t_{d(on)}$	Turn-On Delay Time	$V_{CC} = 600\text{ V}, I_C = 25\text{ A}, R_G = 10\ \Omega, V_{GE} = 15\text{ V},$ Inductive Load, $T_C = 125^\circ\text{C}$	-	50		ns
t_r	Rise Time		-	60		ns
$t_{d(off)}$	Turn-Off Fall Time		-	200		ns
t_f	Fall Time		-	154		ns
E_{on}	Turn-On Switching Loss		-	4.3		mJ
E_{off}	Turn-Off Switching Loss		-	1.5		mJ
E_{ts}	Total Switching Loss		-	5.8		mJ
Q_g	Total Gate Charge	$V_{CE} = 600\text{ V}, I_C = 25\text{ A}, V_{GE} = 15\text{ V}$	-	200		nC
Q_{ge}	Gate-Emitter Charge		-	15		nC
Q_{gc}	Gate-Collector Charge		-	100		nC

Product parametric performance is indicated in the Electrical Characteristics for the listed test conditions, unless otherwise noted. Product performance may not be indicated by the Electrical Characteristics if operated under different conditions.

FGA25N120ANTDTU

ELECTRICAL CHARACTERISTICS OF DIODE ($T_C = 25^\circ\text{C}$ unless otherwise noted)

Symbol	Parameter	Test Conditions		Min.	Typ.	Max.	Unit
V_{FM}	Diode Forward Voltage	$I_F = 25\text{ A}$	$T_C = 25^\circ\text{C}$	-	2.0	3.0	V
			$T_C = 125^\circ\text{C}$	-	2.1	-	
t_{rr}	Diode Reverse Recovery Time	$I_F = 25\text{ A},$ $di_F/dt = 100\text{ A}/\mu\text{s}$	$T_C = 25^\circ\text{C}$	-	235	350	ns
			$T_C = 125^\circ\text{C}$	-	300	-	
I_{rr}	Diode Peak Reverse Recovery Current	$I_F = 25\text{ A},$ $di_F/dt = 100\text{ A}/\mu\text{s}$	$T_C = 25^\circ\text{C}$	-	27	40	A
			$T_C = 125^\circ\text{C}$	-	31	-	
Q_{rr}	Diode Reverse Recovery Charge	$I_F = 25\text{ A},$ $di_F/dt = 100\text{ A}/\mu\text{s}$	$T_C = 25^\circ\text{C}$	-	3130	4700	nC
			$T_C = 125^\circ\text{C}$	-	4650	-	

TYPICAL PERFORMANCE CHARACTERISTICS

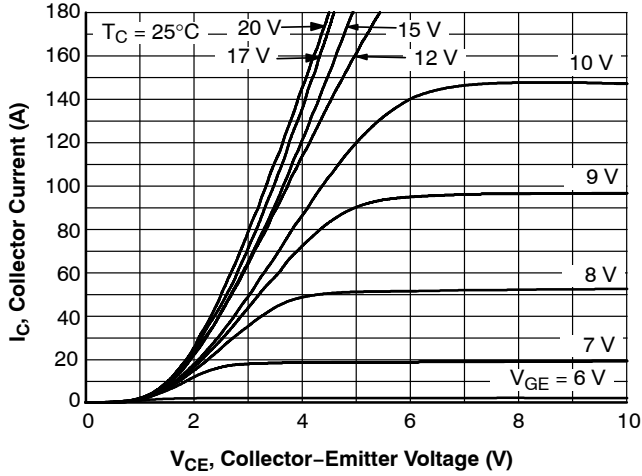

Figure 1. Typical Output Characteristics

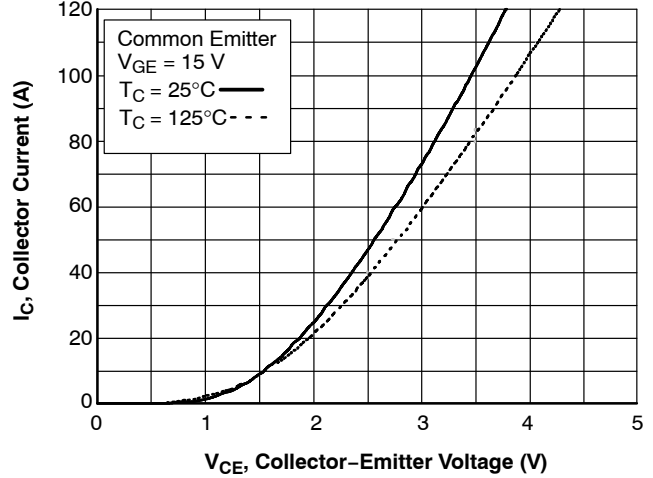

Figure 2. Typical Saturation Voltage Characteristics

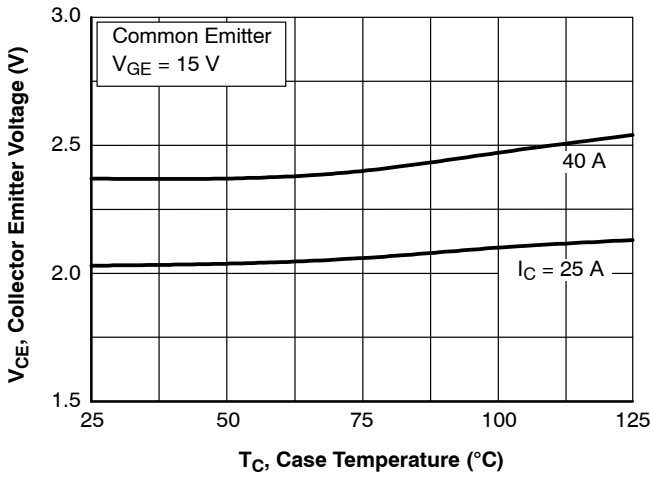

Figure 3. Saturation Voltage vs. Case Temperature at Variant Current Level

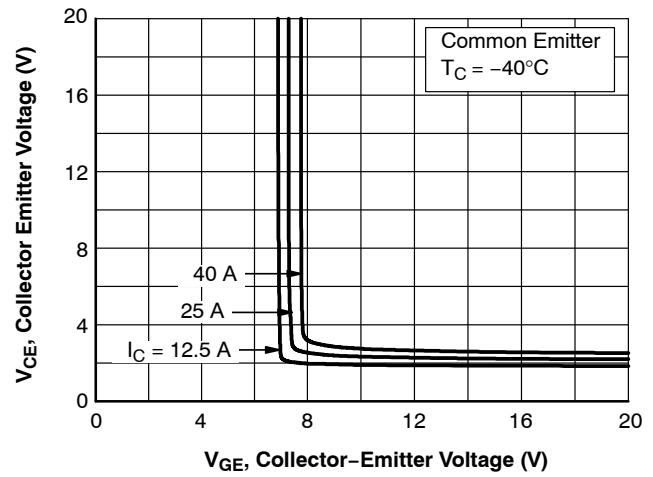

Figure 4. V_{GE} vs Saturation Voltage

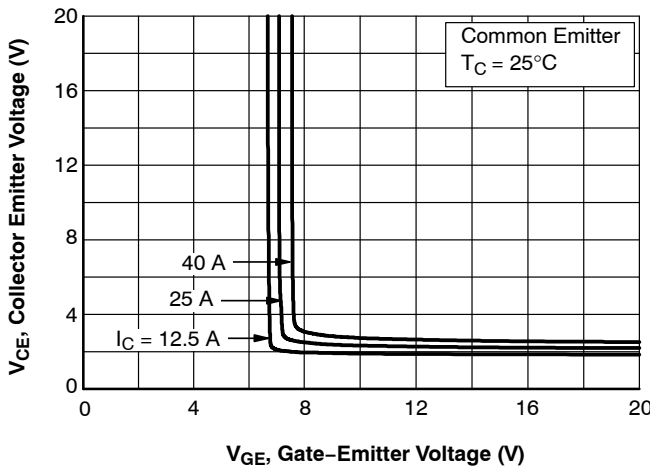

Figure 5. V_{GE} vs. Saturation Voltage

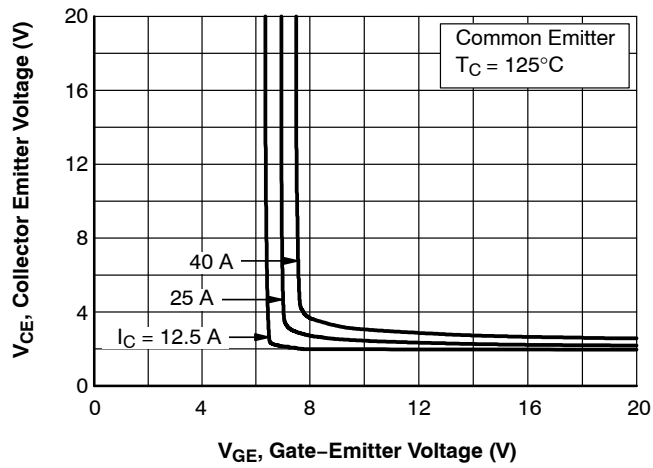

Figure 6. V_{GE} vs. Saturation Voltage

FGA25N120ANTDTU

TYPICAL PERFORMANCE CHARACTERISTICS (CONTINUED)

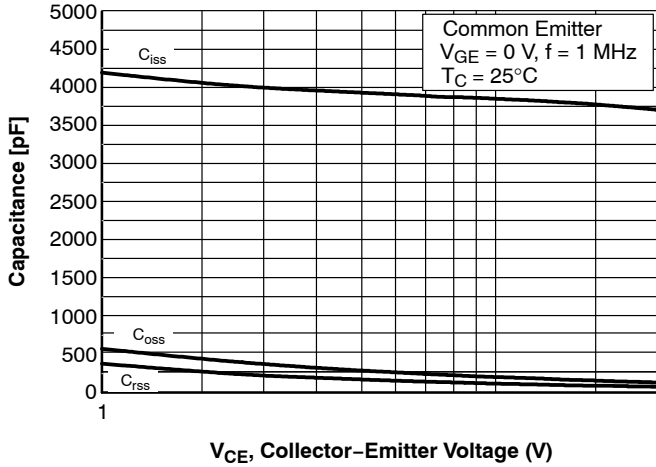

Figure 7. Capacitance Characteristics

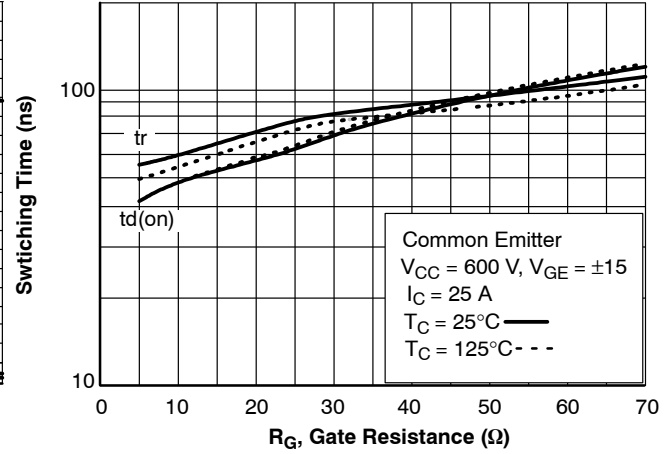

Figure 8. Turn On-Characteristics vs. Gate Resistance

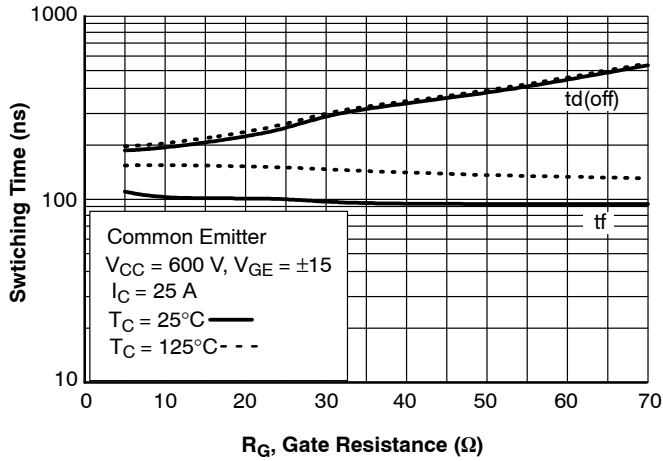

Figure 9. Turn Off-Characteristics vs. Gate Resistance

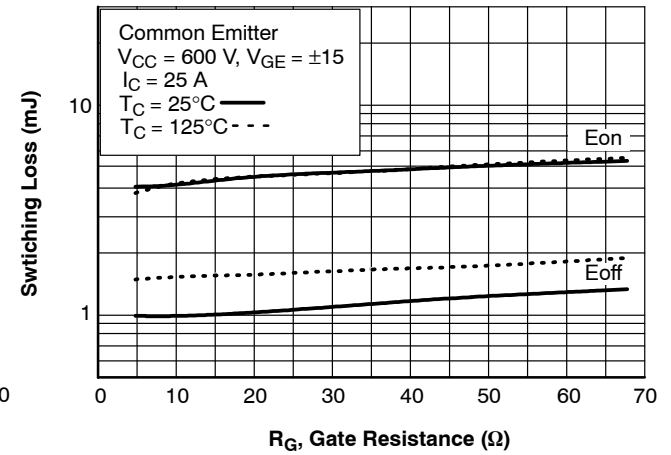

Figure 10. Switching Loss vs. Gate Resistance

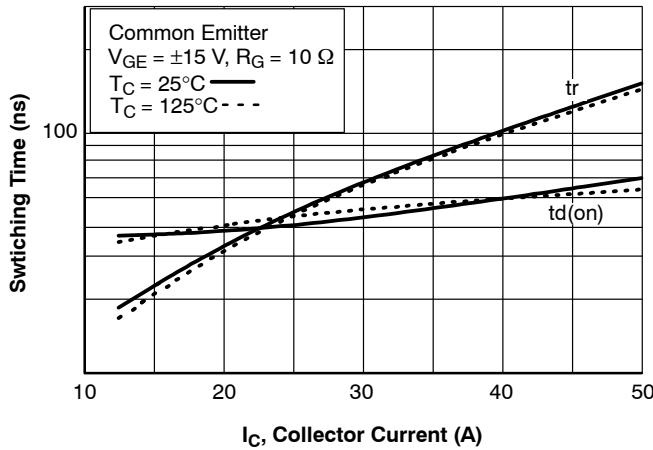

Figure 11. Turn-On Characteristics vs. Collector Current

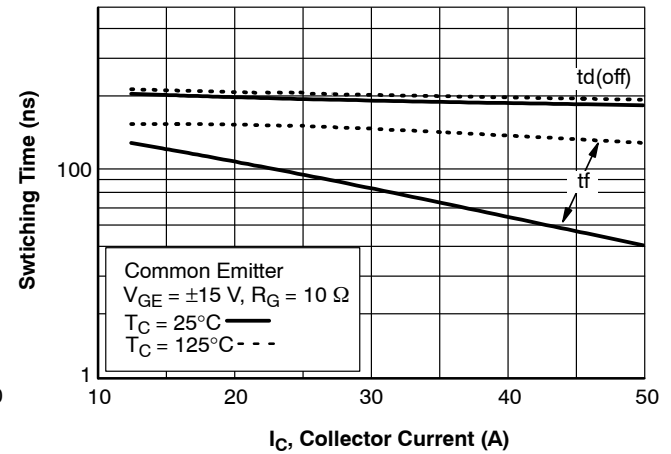

Figure 12. Turn-Off Characteristics vs. Collector Current

FGA25N120ANTDTU

TYPICAL PERFORMANCE CHARACTERISTICS (CONTINUED)

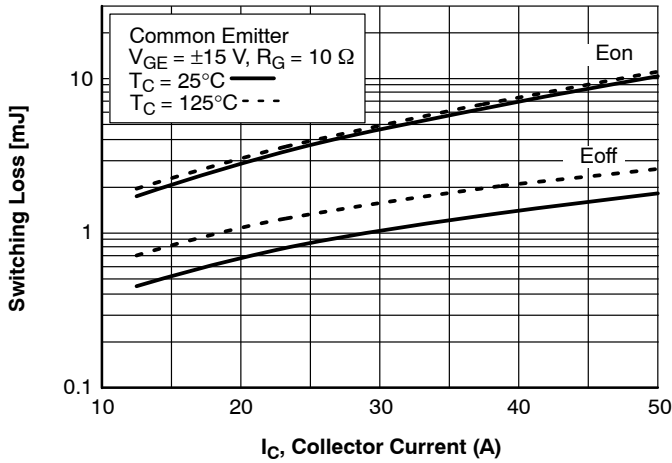

Figure 13. Switching Loss vs Collector Current

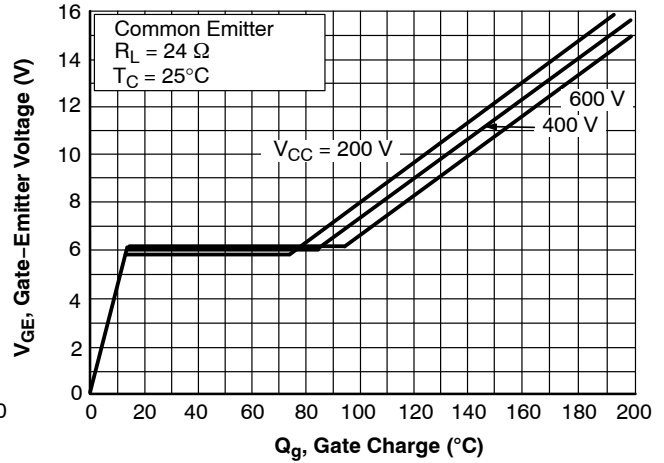

Figure 14. Gate Charge Characteristics

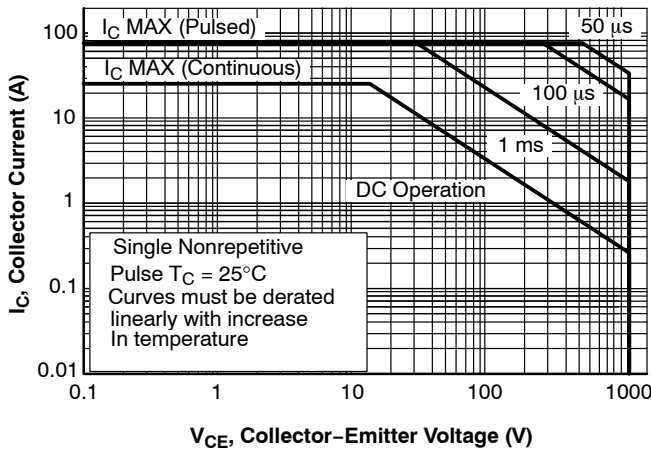

Figure 15. SOA Characteristics

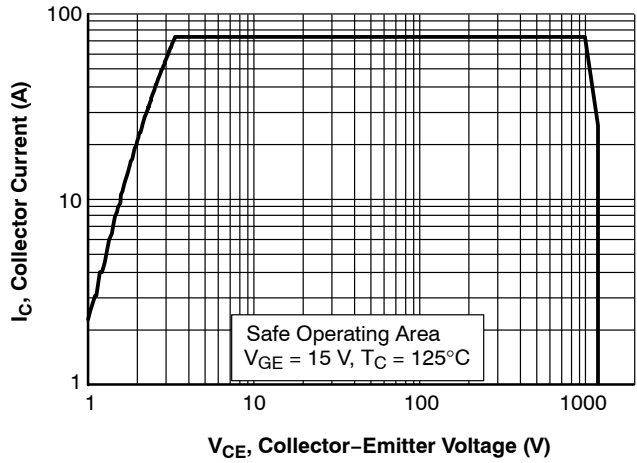

Figure 16. Turn-Off SOA

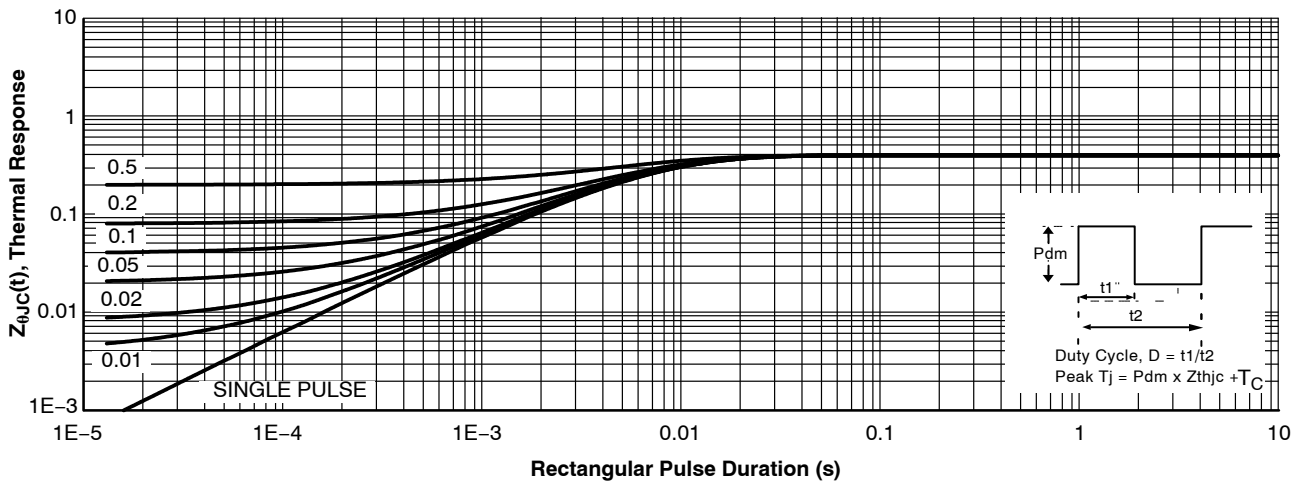

Figure 17. Transient Thermal Impedance of IGBT

TYPICAL PERFORMANCE CHARACTERISTICS (CONTINUED)

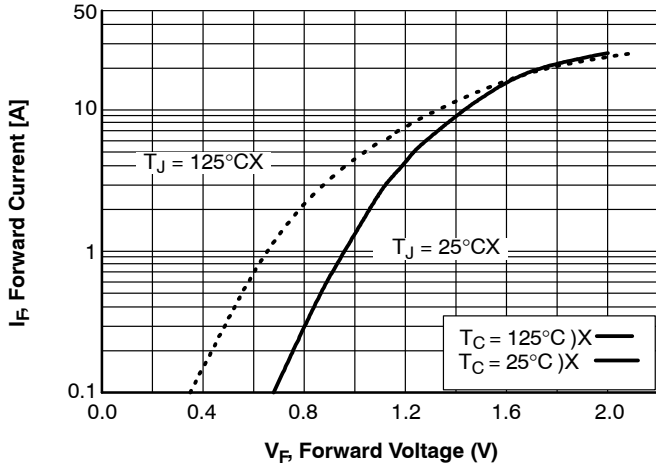

Figure 18. Forward Characteristics

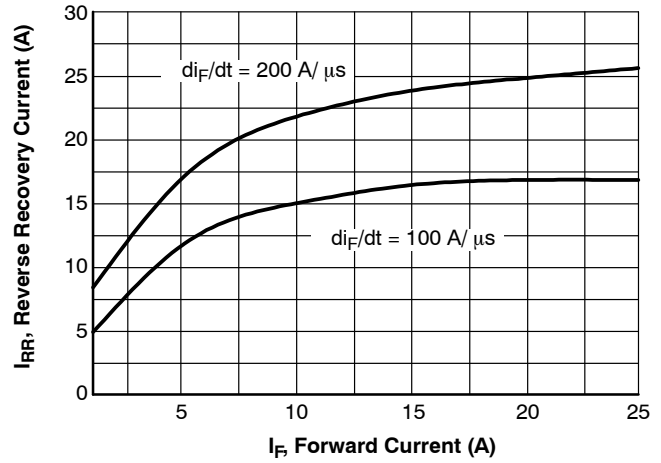

Figure 19. Reverse Recovery Current

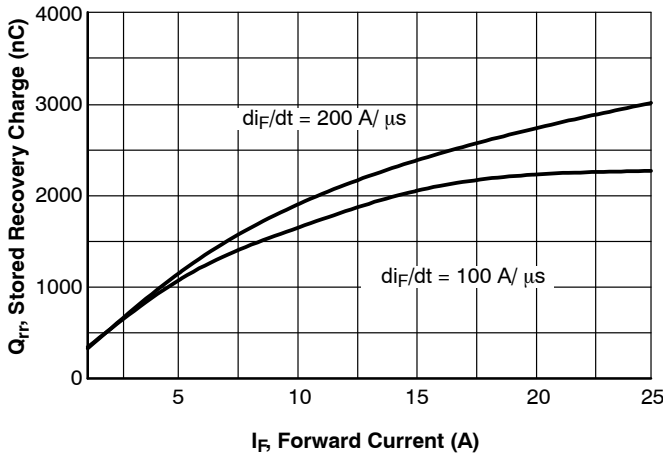

Figure 20. Stored Charge

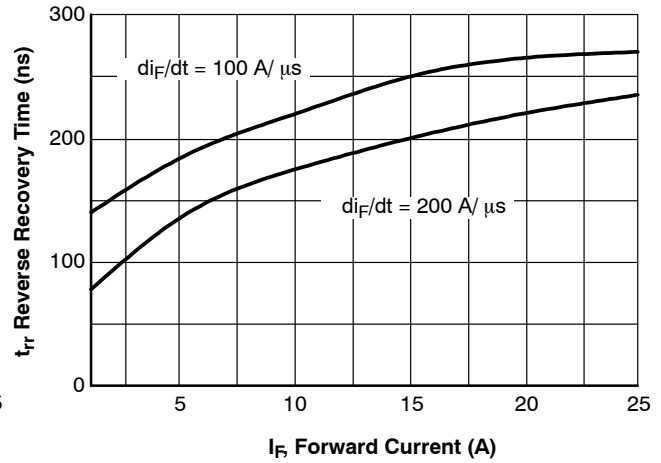
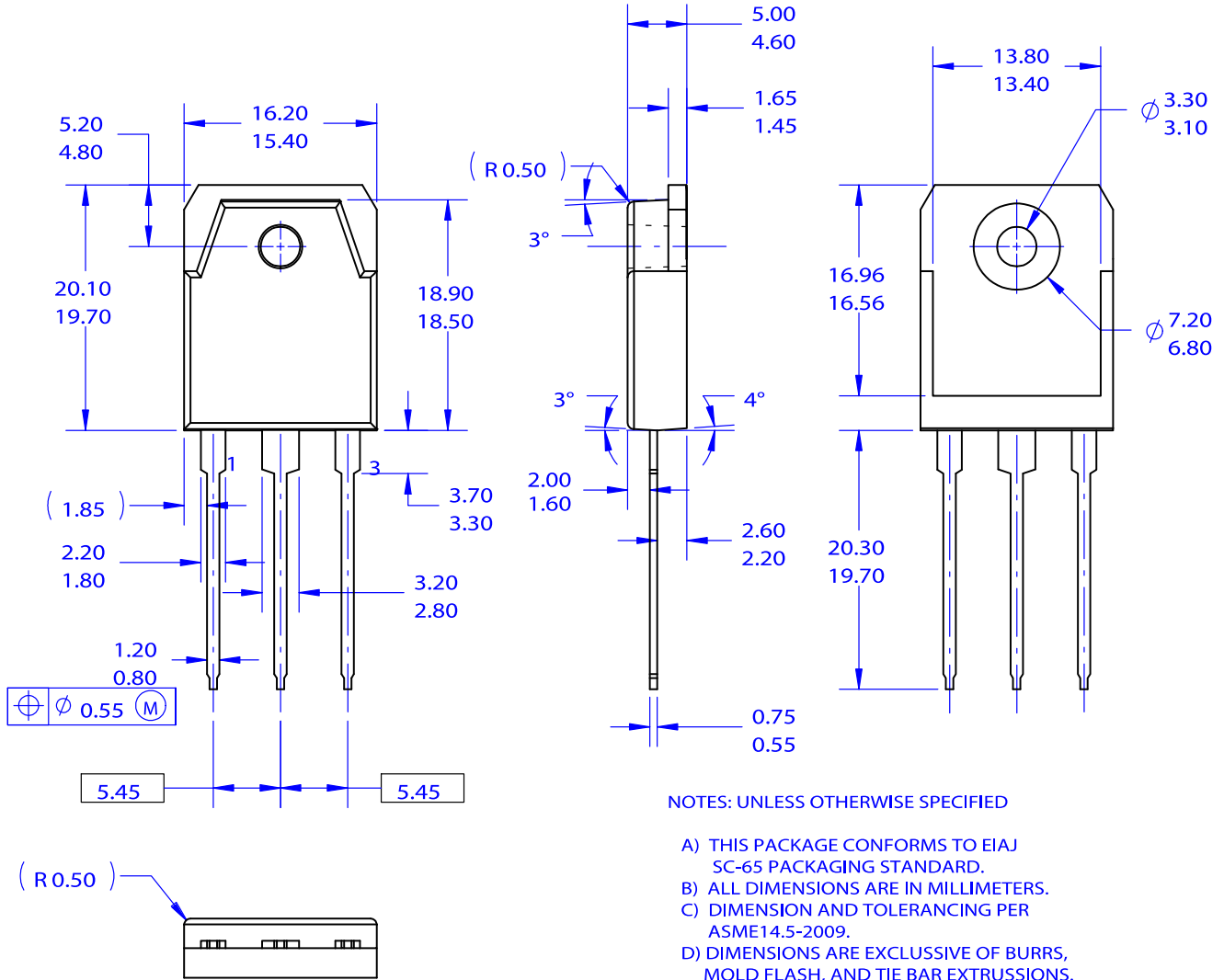

Figure 21. Reverse Recovery Time

TO-3P-3LD / EIAJ SC-65, ISOLATED
CASE 340BZ
ISSUE O

DATE 31 OCT 2016



DOCUMENT NUMBER:	98AON13862G	Electronic versions are uncontrolled except when accessed directly from the Document Repository. Printed versions are uncontrolled except when stamped "CONTROLLED COPY" in red.
DESCRIPTION:	TO-3P-3LD / EIAJ SC-65, ISOLATED	PAGE 1 OF 1

onsemi and Onsemi are trademarks of Semiconductor Components Industries, LLC dba onsemi or its subsidiaries in the United States and/or other countries. onsemi reserves the right to make changes without further notice to any products herein. onsemi makes no warranty, representation or guarantee regarding the suitability of its products for any particular purpose, nor does onsemi assume any liability arising out of the application or use of any product or circuit, and specifically disclaims any and all liability, including without limitation special, consequential or incidental damages. onsemi does not convey any license under its patent rights nor the rights of others.

onsemi, **Onsemi**, and other names, marks, and brands are registered and/or common law trademarks of Semiconductor Components Industries, LLC dba "**onsemi**" or its affiliates and/or subsidiaries in the United States and/or other countries. **onsemi** owns the rights to a number of patents, trademarks, copyrights, trade secrets, and other intellectual property. A listing of **onsemi**'s product/patent coverage may be accessed at www.onsemi.com/site/pdf/Patent-Marking.pdf. **onsemi** reserves the right to make changes at any time to any products or information herein, without notice. The information herein is provided "as-is" and **onsemi** makes no warranty, representation or guarantee regarding the accuracy of the information, product features, availability, functionality, or suitability of its products for any particular purpose, nor does **onsemi** assume any liability arising out of the application or use of any product or circuit, and specifically disclaims any and all liability, including without limitation special, consequential or incidental damages. Buyer is responsible for its products and applications using **onsemi** products, including compliance with all laws, regulations and safety requirements or standards, regardless of any support or applications information provided by **onsemi**. "Typical" parameters which may be provided in **onsemi** data sheets and/or specifications can and do vary in different applications and actual performance may vary over time. All operating parameters, including "Typicals" must be validated for each customer application by customer's technical experts. **onsemi** does not convey any license under any of its intellectual property rights nor the rights of others. **onsemi** products are not designed, intended, or authorized for use as a critical component in life support systems or any FDA Class 3 medical devices or medical devices with a same or similar classification in a foreign jurisdiction or any devices intended for implantation in the human body. Should Buyer purchase or use **onsemi** products for any such unintended or unauthorized application, Buyer shall indemnify and hold **onsemi** and its officers, employees, subsidiaries, affiliates, and distributors harmless against all claims, costs, damages, and expenses, and reasonable attorney fees arising out of, directly or indirectly, any claim of personal injury or death associated with such unintended or unauthorized use, even if such claim alleges that **onsemi** was negligent regarding the design or manufacture of the part. **onsemi** is an Equal Opportunity/Affirmative Action Employer. This literature is subject to all applicable copyright laws and is not for resale in any manner.

ADDITIONAL INFORMATION

TECHNICAL PUBLICATIONS:

Technical Library: www.onsemi.com/design/resources/technical-documentation
onsemi Website: www.onsemi.com

ONLINE SUPPORT: www.onsemi.com/support

For additional information, please contact your local Sales Representative at www.onsemi.com/support/sales