

4-Pin DIP Phototransistor Optocouplers

FOD814, FOD817

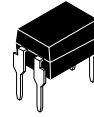

PDIP4
CASE 646CD
CASE 646CA

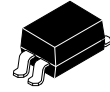

PDIP4 GW
CASE 709AH

Introduction or Description

The FOD814 consists of two gallium arsenide infrared emitting diodes, connected in inverse parallel, driving a silicon phototransistor output in a 4-pin dual in-line package. The FOD817 Series consists of a gallium arsenide infrared emitting diode driving a silicon phototransistor in a 4-pin dual in-line package.

Features

- AC Input Response (FOD814)
- Current Transfer Ratio in Selected Groups
 - ◆ FOD814: 20–300%
 - ◆ FOD814A: 50–150%
 - ◆ FOD817: 50–600%
 - ◆ FOD817A: 80–160%
 - ◆ FOD817B: 130–260%
 - ◆ FOD817C: 200–400%
 - ◆ FOD817D: 300–600%
- Minimum BV_{CEO} of 70 V Guaranteed
- Safety and Regulatory Approvals
 - ◆ UL1577, 5,000 VAC_{RMS} for 1 Minute
 - ◆ DIN EN/IEC60747–5–5
- This Device is Pb-Free

Typical Applications

- FOD814 Series
 - ◆ AC Line Monitor
 - ◆ Unknown Polarity DC Sensor
 - ◆ Telephone Line Interface
- FOD817 Series
 - ◆ Power Supply Regulators
 - ◆ Digital Logic Inputs
 - ◆ Microprocessor Inputs

MARKING DIAGRAM

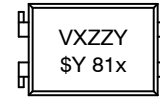

- | | |
|-----|-------------------------|
| V | = VDE Mark |
| X | = One Digit Year Code |
| ZZ | = Two Digit Work Week |
| Y | = Assembly Package Code |
| \$Y | = Logo |
| 81x | = Specific Device Code |
| | x = 4 or 7 |

ORDERING INFORMATION

See detailed ordering and shipping information on page 8 of this data sheet.

FOD814, FOD817

FUNCTIONAL BLOCK DIAGRAM

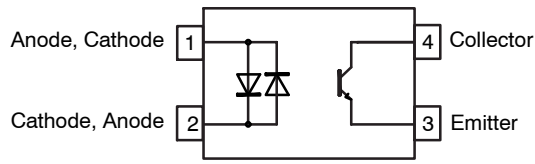

Figure 1. Schematic – FOD814

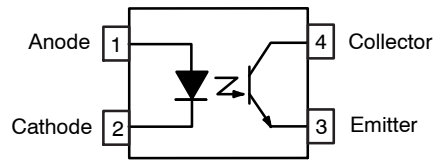

Figure 2. Schematic – FOD817

SAFETY AND INSULATION RATINGS

Parameter	Characteristics	
Installation Classifications per DIN VDE 0110/1.89 Table 1, For Rated Mains Voltage	< 150 V _{RMS}	I–IV
	< 300 V _{RMS}	I–III
Climatic Classification	30/110/21	
Pollution Degree (DIN VDE 0110/1.89)	2	
Comparative Tracking Index	175	

Symbol	Parameter	Value	Unit
V _{PR}	Input-to-Output Test Voltage, Method A, V _{IORM} × 1.6 = V _{PR} , Type and Sample Test with t _m = 10 s, Partial Discharge < 5 pC	1360	V _{peak}
	Input-to-Output Test Voltage, Method B, V _{IORM} × 1.875 = V _{PR} , 100% Production Test with t _m = 1 s, Partial Discharge < 5 pC	1594	
V _{IORM}	Maximum Working Insulation Voltage	850	
V _{IOTM}	Highest Allowable Over-Voltage	8000	
	External Creepage	≥ 7	mm
	External Clearance	≥ 7	
	External Clearance (for Option W, 0.4" Lead Spacing)	≥ 10	
DTI	Distance Through Insulation (Insulation Thickness)	≥ 0.4	
T _S	Case Temperature (Note 1)	175	°C
I _{S,INPUT}	Input Current (Note 1)	400	mA
P _{S,OUTPUT}	Output Power (Note 1)	700	mW
R _{IO}	Insulation Resistance at T _S , V _{IO} = 500 V (Note 1)	> 10 ¹¹	Ω

As per DIN EN/IEC 60747–5–5, this optocoupler is suitable for “safe electrical insulation” only within the safety limit data. Compliance with the safety ratings shall be ensured by means of protective circuits.

1. Safety limit values – maximum values allowed in the event of a failure.

ABSOLUTE MAXIMUM RATINGS T_A = 25°C unless otherwise specified.

Symbol	Parameter	Value		Unit
		FOD814	FOD817	

TOTAL DEVICE

T _{STG}	Storage Temperature	–55 to +150		°C
T _{OPR}	Operating Temperature	–55 to +105	–55 to +110	
T _J	Junction Temperature	–55 to +125		
T _{SOL}	Lead Solder Temperature	260 for 10 s		
θ _{JC}	Junction-to-Case Thermal Resistance	210		°C/W
P _{TOT}	Total Device Power Dissipation	200		mW

FOD814, FOD817

ABSOLUTE MAXIMUM RATINGS $T_A = 25^\circ\text{C}$ unless otherwise specified. (continued)

Symbol	Parameter	Value		Unit
		FOD814	FOD817	

EMITTER

I_F	Continuous Forward Current	± 50	50	mA
V_R	Reverse Voltage		6	V
P_D	Power Dissipation	70		mW
	Derate Above 100°C	1.7		mW/ $^\circ\text{C}$

DETECTOR

V_{CE0}	Collector–Emitter Voltage	70		V
V_{ECO}	Emitter–Collector Voltage	6		
I_C	Continuous Collector Current	50		mA
P_C	Collector Power Dissipation	150		mW
	Derate Above 90°C	2.9		mW/ $^\circ\text{C}$

Stresses exceeding those listed in the Maximum Ratings table may damage the device. If any of these limits are exceeded, device functionality should not be assumed, damage may occur and reliability may be affected.

ELECTRICAL CHARACTERISTICS $T_A = 25^\circ\text{C}$ unless otherwise specified.

INDIVIDUAL COMPONENT CHARACTERISTICS

Symbol	Parameter	Device	Test Conditions	Min	Typ	Max	Unit
--------	-----------	--------	-----------------	-----	-----	-----	------

Emitter

V_F	Forward Voltage	FOD814	$I_F = \pm 20\text{ mA}$	–	1.2	1.4	V
		FOD817	$I_F = 20\text{ mA}$	–	1.2	1.4	
I_R	Reverse Current	FOD817	$V_R = 4.0\text{ V}$	–	–	10	μA
C_t	Terminal Capacitance	FOD814	$V = 0, f = 1\text{ kHz}$	–	50	250	pF
		FOD817		–	30	250	

Detector

I_{CE0}	Collector Dark Current	FOD814	$V_{CE} = 20\text{ V}, I_F = 0$	–	–	100	nA
		FOD817		–	–	100	
BV_{CE0}	Collector–Emitter Breakdown Voltage	FOD814	$I_C = 0.1\text{ mA}, I_F = 0$	70	–	–	V
		FOD817		70	–	–	
BV_{ECO}	Emitter–Collector Breakdown Voltage	FOD814	$I_E = 10\text{ }\mu\text{A}, I_F = 0$	6	–	–	V
		FOD817		6	–	–	

DC TRANSFER CHARACTERISTICS

Symbol	Parameter	Device	Test Conditions	Min	Typ	Max	Unit
CTR	Current Transfer Ratio (Note 2)	FOD814	$I_F = \pm 1\text{ mA}, V_{CE} = 5\text{ V}$	20	–	300	%
		FOD814A		50	–	150	
		FOD817	$I_F = 5\text{ mA}, V_{CE} = 5\text{ V}$	50	–	600	
		FOD817A		80	–	160	
		FOD817B		130	–	260	
		FOD817C		200	–	400	
		FOD817D		300	–	600	
$V_{CE(SAT)}$	Collector–Emitter Saturation Voltage	FOD814	$I_F = \pm 20\text{ mA}, I_C = 1\text{ mA}$	–	0.1	0.2	V
		FOD817	$I_F = 20\text{ mA}, I_C = 1\text{ mA}$	–	0.1	0.2	

FOD814, FOD817

ELECTRICAL CHARACTERISTICS $T_A = 25^\circ\text{C}$ unless otherwise specified. (continued)

AC TRANSFER CHARACTERISTICS

Symbol	Parameter	Device	Test Conditions	Min	Typ	Max	Unit
f_c	Cut-Off Frequency	FOD814	$V_{CE} = 5\text{ V}$, $I_C = 2\text{ mA}$, $R_L = 100\ \Omega$, -3 dB	15	80	–	kHz
t_r	Response Time (Rise)	FOD814, FOD817	$V_{CE} = 2\text{ V}$, $I_C = 2\text{ mA}$, $R_L = 100\ \Omega$ (Note 3)	–	4	18	μs
t_f	Response Time (Fall)	FOD814, FOD817		–	3	18	

ISOLATION CHARACTERISTICS

Symbol	Parameter	Device	Test Conditions	Min	Typ	Max	Unit
V_{ISO}	Input-Output Isolation Voltage (Note 4)	FOD814, FOD817	$f = 60\text{ Hz}$, $t = 1\text{ min}$, $I_{I-O} \leq 2\ \mu\text{A}$	5000	–	–	$V_{AC_{RMS}}$
R_{ISO}	Isolation Resistance	FOD814, FOD817	$V_{I-O} = 500\text{ V}_{DC}$	5×10^{10}	1×10^{11}	–	Ω
C_{ISO}	Isolation Capacitance	FOD814, FOD817	$V_{I-O} = 0$, $f = 1\text{ MHz}$	–	0.6	1.0	pf

Product parametric performance is indicated in the Electrical Characteristics for the listed test conditions, unless otherwise noted. Product performance may not be indicated by the Electrical Characteristics if operated under different conditions.

- Current Transfer Ratio (CTR) = $I_C / I_F \times 100\%$
- For test circuit setup and waveforms, refer to page 5.
- For this test, Pins 1 and 2 are common, and Pins 3 and 4 are common.

TYPICAL ELECTRICAL/OPTICAL CHARACTERISTICS CURVES

$T_A = 25^\circ\text{C}$ unless otherwise specified.

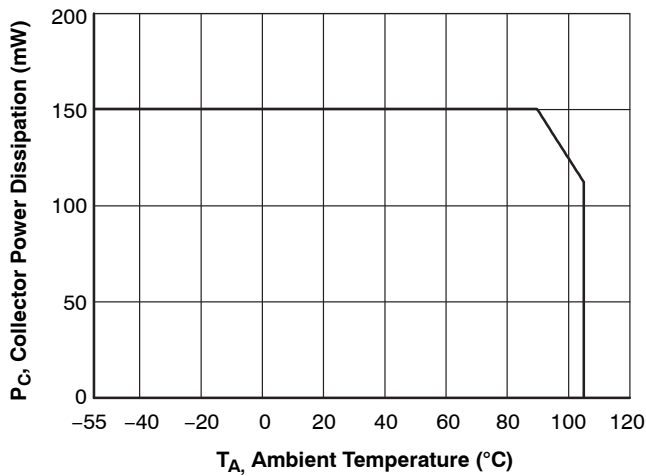

Figure 3. Collector Power Dissipation vs. Ambient Temperature (FOD814)

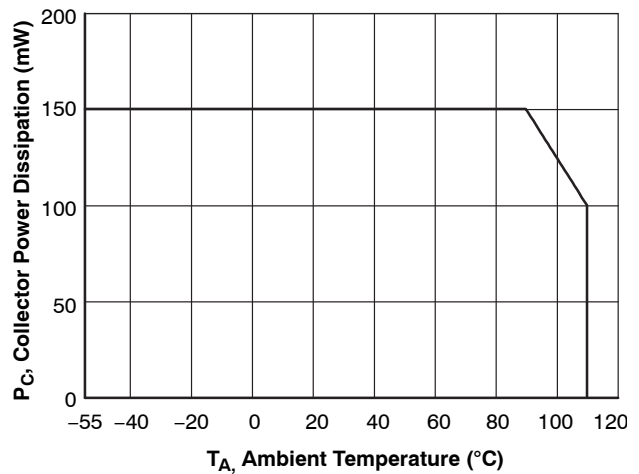

Figure 4. Collector Power Dissipation vs. Ambient Temperature (FOD817)

FOD814, FOD817

TYPICAL ELECTRICAL/OPTICAL CHARACTERISTICS CURVES

$T_A = 25^\circ\text{C}$ unless otherwise specified. (continued)

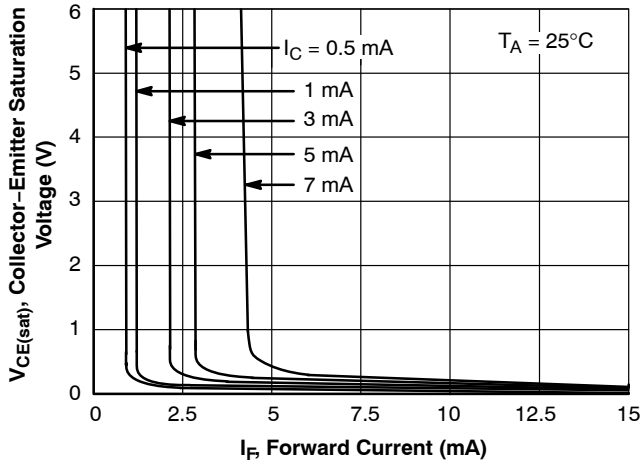

Figure 5. Collector-Emitter Saturation Voltage vs. Forward Current

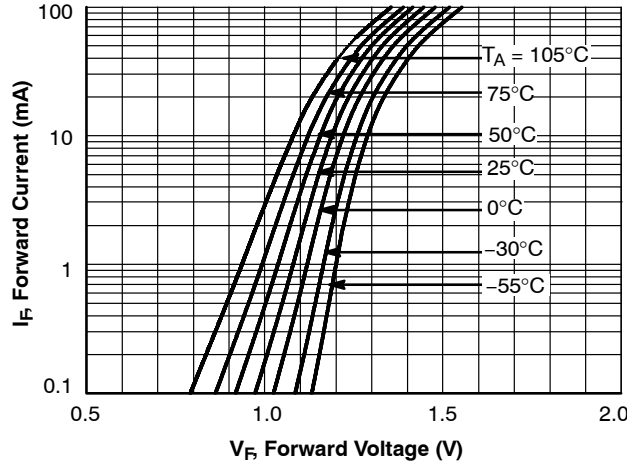

Figure 6. Forward Current vs. Forward Voltage (FOD814)

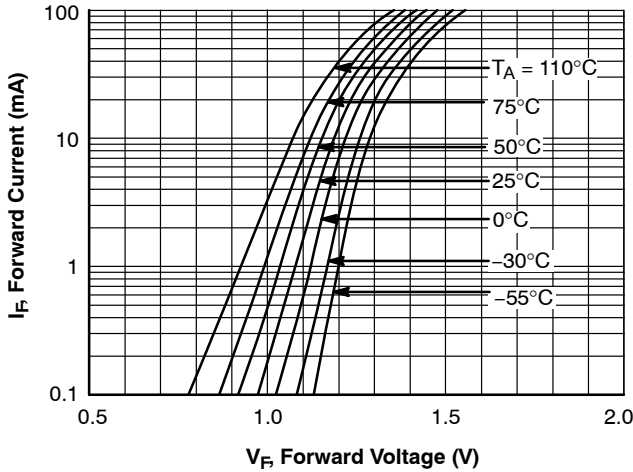

Figure 7. Forward Current vs. Forward Voltage (FOD817)

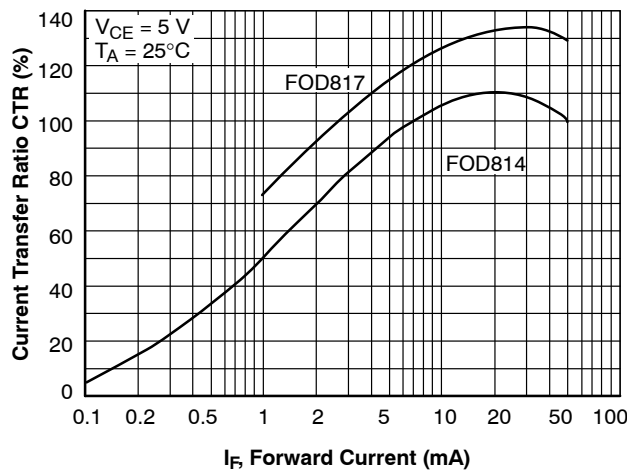

Figure 8. Current Transfer Ratio vs. Forward Current

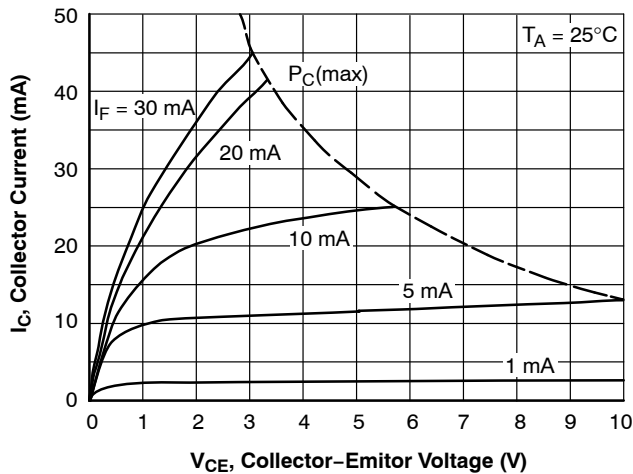

Figure 9. Collector Current vs. Collector-Emitter Voltage (FOD814)

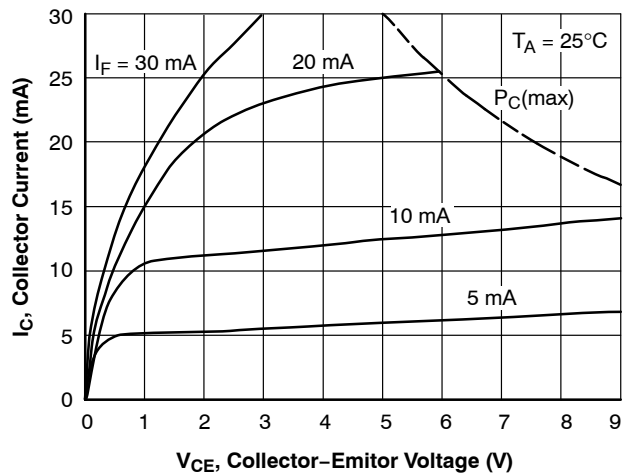

Figure 10. Collector Current vs. Collector-Emitter Voltage (FOD817)

FOD814, FOD817

TYPICAL ELECTRICAL/OPTICAL CHARACTERISTICS CURVES

$T_A = 25^\circ\text{C}$ unless otherwise specified. (continued)

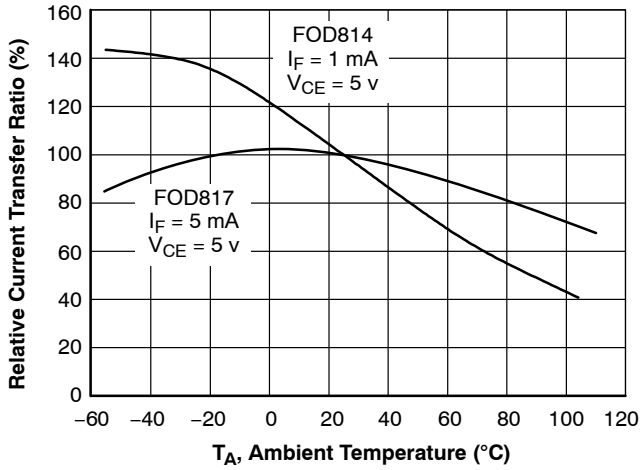

Figure 11. Relative Current Transfer Ratio vs. Ambient Temperature

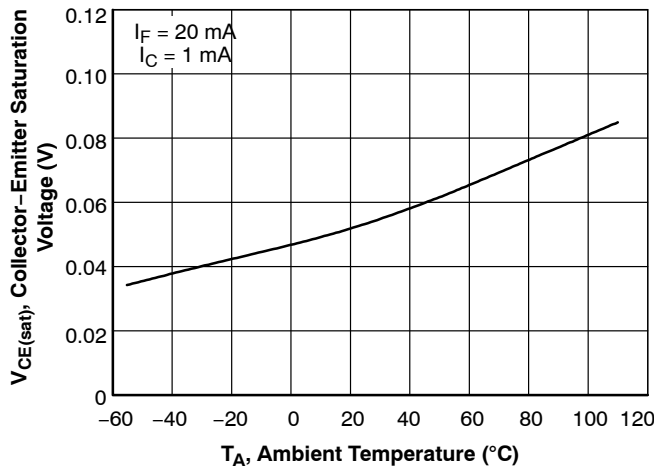

Figure 12. Collector-Emitter Saturation Voltage vs. Ambient Temperature

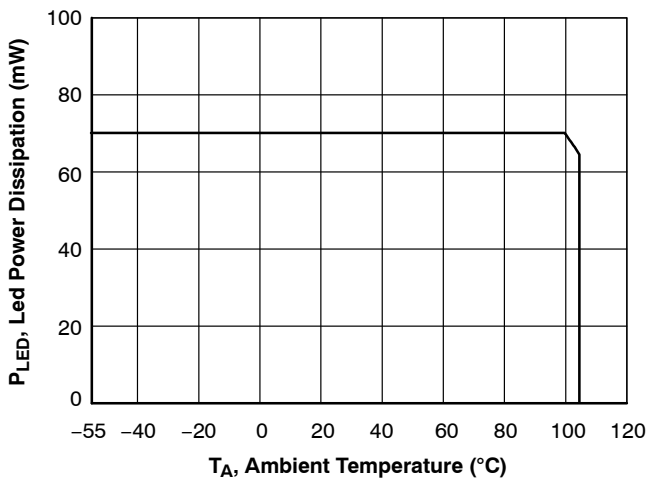

Figure 13. Led Power Dissipation vs. Ambient Temperature (FOD814)

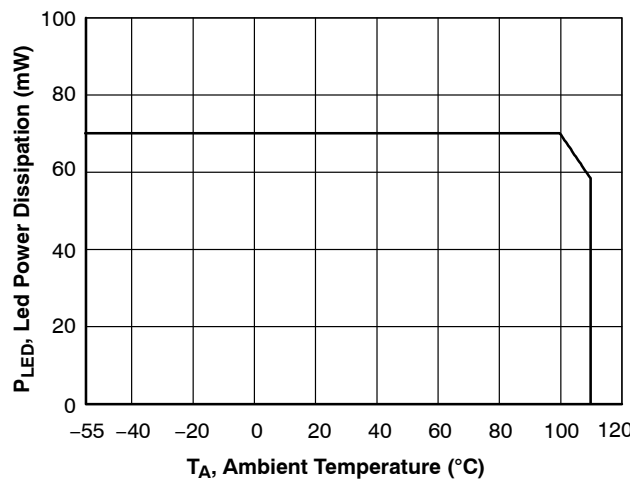

Figure 14. Led Power Dissipation vs. Ambient Temperature (FOD817)

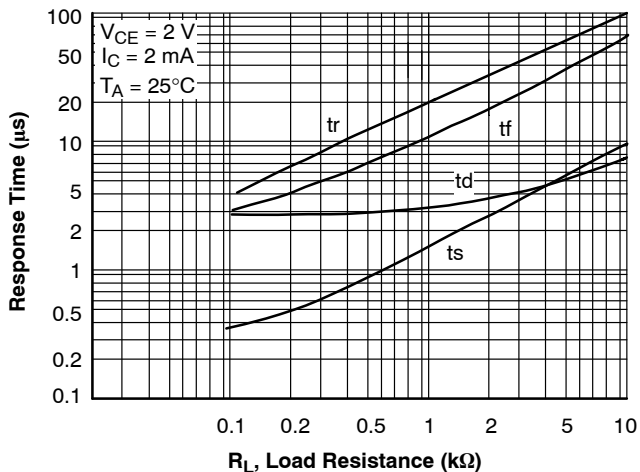

Figure 15. Response Time vs. Load Resistance

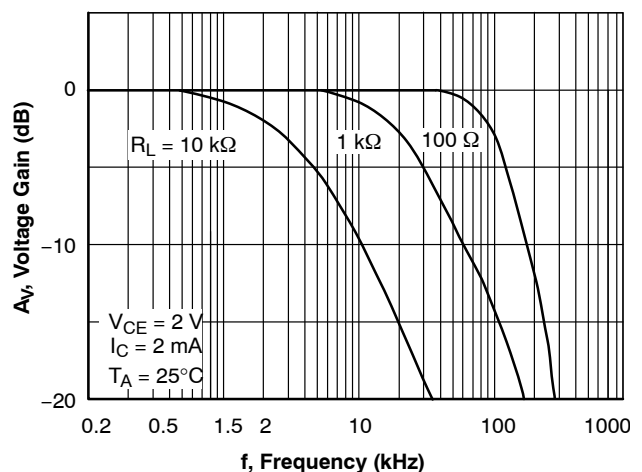

Figure 16. Frequency Response

FOD814, FOD817

TYPICAL ELECTRICAL/OPTICAL CHARACTERISTICS CURVES

$T_A = 25^\circ\text{C}$ unless otherwise specified. (continued)

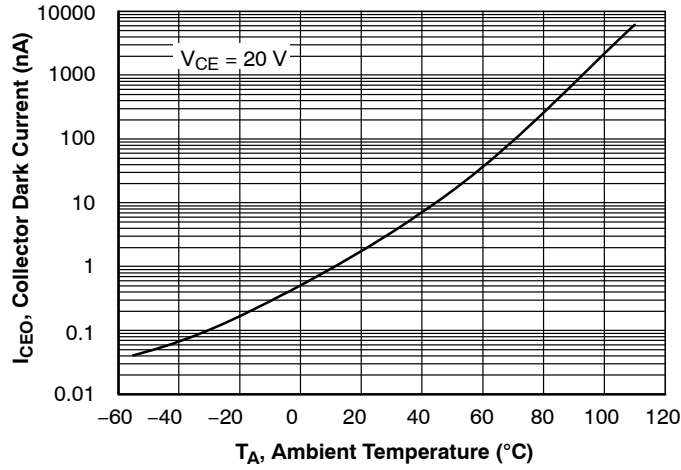

Figure 17. Collector Dark Current vs. Ambient Temperature

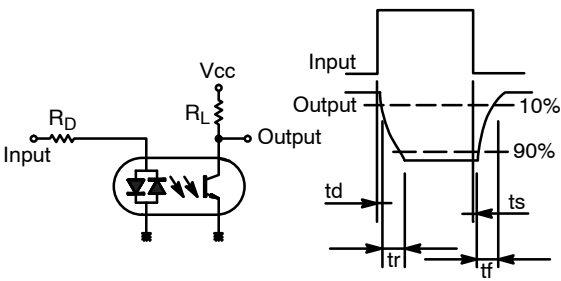

Figure 18. Test Circuit for Response Time

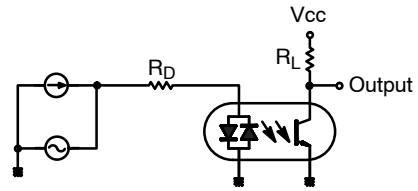

Figure 19. Test Circuit for Frequency Response

FOD814, FOD817

REFLOW PROFILE

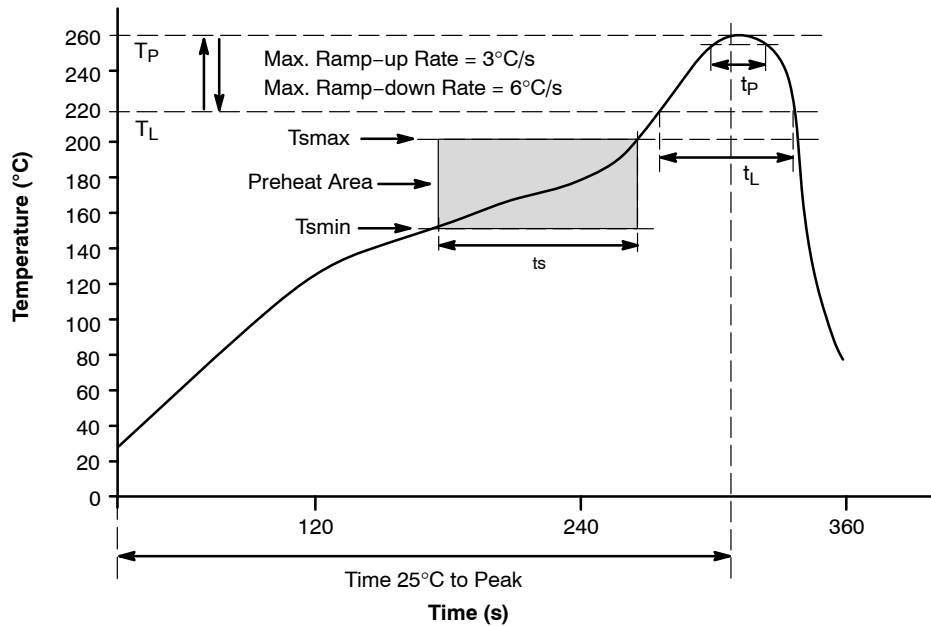

Figure 20. Reflow Profile

REFLOW PROFILE

Profile Feature	Pb-Free Assembly Profile
Temperature Min. (Tmin)	150°C
Temperature Max. (Tmax)	200°C
Time (ts) from (Tmin to Tmax)	60–120 s
Ramp-up Rate (tL to tp)	3°C/s max.
Liquidous Temperature (TL)	217°C
Time (tL) Maintained Above (TL)	60–150 s
Peak Body Package Temperature	260°C +0°C / -5°C
Time (tp) within 5°C of 260°C	30 s
Ramp-down Rate (TP to TL)	6°C/s max.
Time 25°C to Peak Temperature	8 min max.

ORDERING INFORMATION

Part Number	Package	Shipping [†]
FOD817X	DIP 4-Pin	Tube (100 units per tube)
FOD817XS	SMT 4-Pin (Lead Bend)	Tube (100 units per tube)
FOD817XSD	SMT 4-Pin (Lead Bend)	Tape and Reel (1,000 units per reel)
FOD817X300	DIP 4-Pin, DIN EN/IEC60747-5-5 option	Tube (100 units per tube)
FOD817X3S	SMT 4-Pin (Lead Bend), DIN EN/IEC60747-5-5 option	Tube (100 units per tube)
FOD817X3SD	SMT 4-Pin (Lead Bend), DIN EN/IEC60747-5-5 option	Tape and Reel (1,000 units per reel)
FOD817X300W	DIP 4-Pin, 0.4" Lead Spacing, DIN EN/IEC60747-5-5 option	Tube (100 units per tube)

[†]For information on tape and reel specifications, including part orientation and tape sizes, please refer to our Tape and Reel Packaging Specifications Brochure, BRD8011/D.

NOTE: The product orderable part number system listed in this table also applies to the FOD814 products. "X" denotes the Current Transfer Ratio (CTR) options.

PDIP4 4.6x6.5, 2.54P
CASE 646CA
ISSUE O

DATE 31 JUL 2016

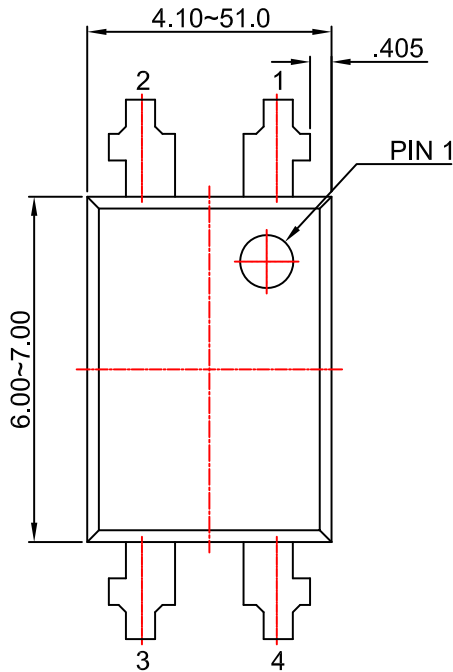

NOTES:

- A) NO STANDARD APPLIES TO THIS PACKAGE.
- B) ALL DIMENSIONS ARE IN MILLIMETERS.
- C) DIMENSIONS ARE EXCLUSIVE OF BURRS, MOLD FLASH, AND TIE BAR EXTRUSION

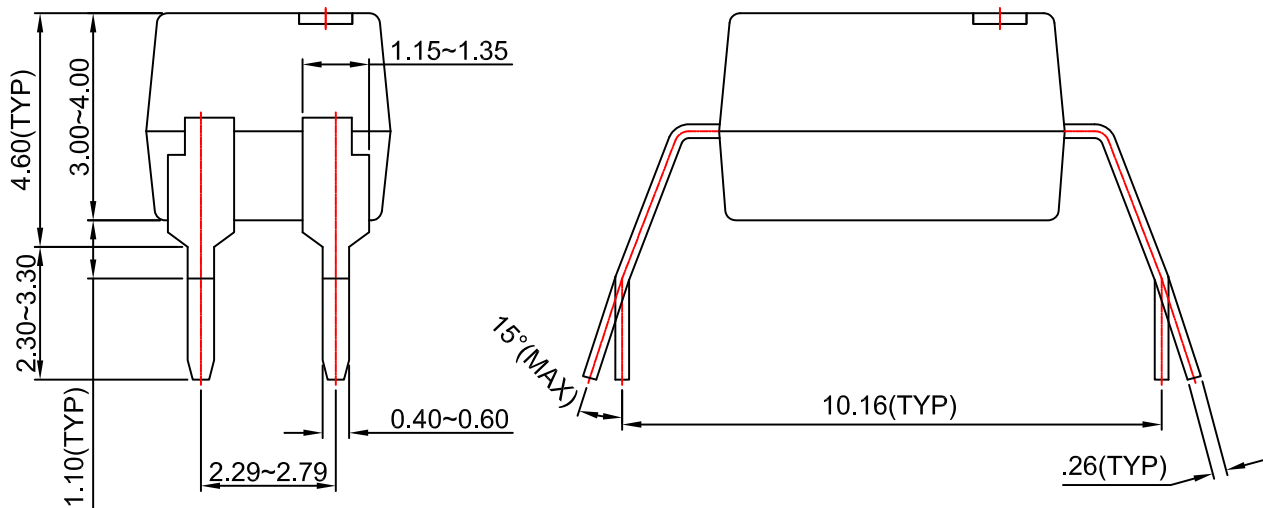

DOCUMENT NUMBER:	98AON13453G	Electronic versions are uncontrolled except when accessed directly from the Document Repository. Printed versions are uncontrolled except when stamped "CONTROLLED COPY" in red.
DESCRIPTION:	PDIP4 4.6X6.5, 2.54P	PAGE 1 OF 1

onsemi and ONSEMI are trademarks of Semiconductor Components Industries, LLC dba onsemi or its subsidiaries in the United States and/or other countries. onsemi reserves the right to make changes without further notice to any products herein. onsemi makes no warranty, representation or guarantee regarding the suitability of its products for any particular purpose, nor does onsemi assume any liability arising out of the application or use of any product or circuit, and specifically disclaims any and all liability, including without limitation special, consequential or incidental damages. onsemi does not convey any license under its patent rights nor the rights of others.

PDIP4 4.6x6.5, 2.54P
CASE 646CD
ISSUE O

DATE 31 JUL 2016

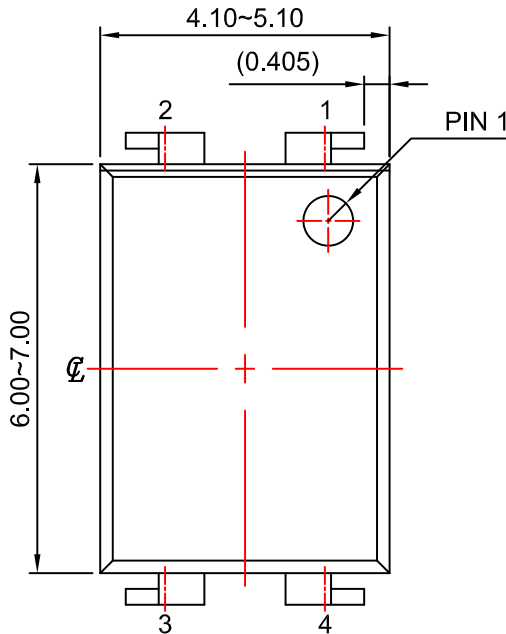

NOTES:

- A) NO STANDARD APPLIES TO THIS PACKAGE.
- B) ALL DIMENSIONS ARE IN MILLIMETERS.
- C) DIMENSIONS ARE EXCLUSIVE OF BURRS, MOLD FLASH, AND TIE BAR EXTRUSION

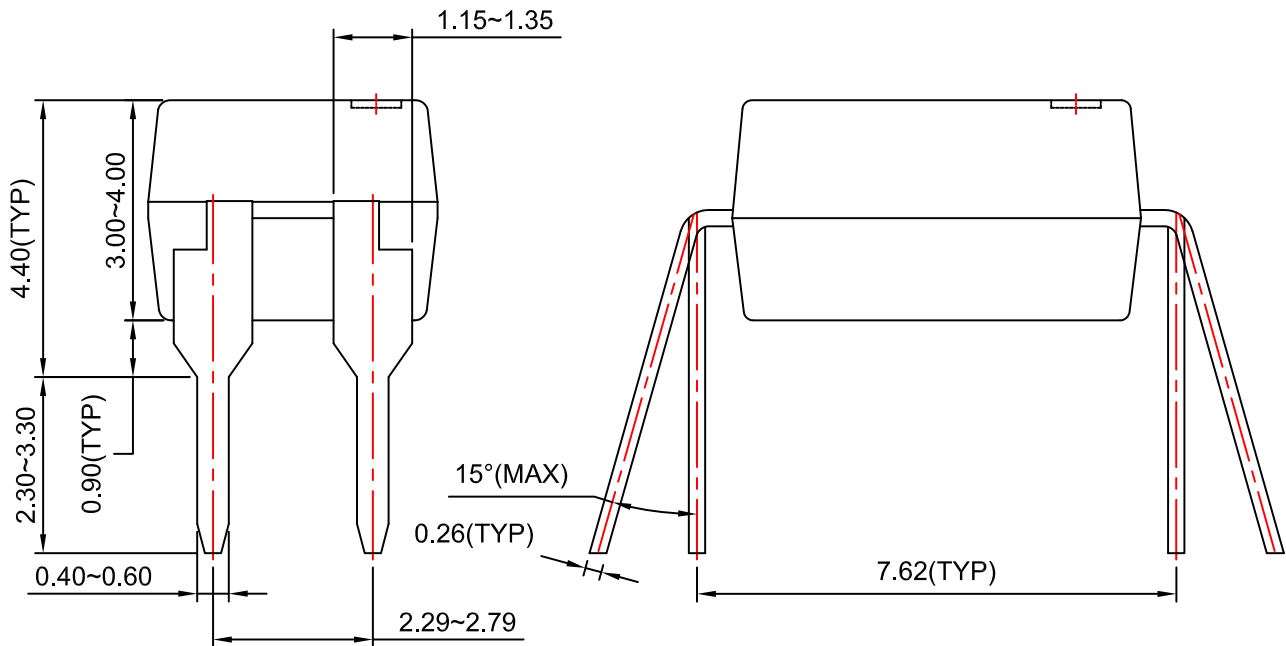

DOCUMENT NUMBER:	98AON13452G	Electronic versions are uncontrolled except when accessed directly from the Document Repository. Printed versions are uncontrolled except when stamped "CONTROLLED COPY" in red.
DESCRIPTION:	PDIP4 4.6X6.5, 2.54P	PAGE 1 OF 1

onsemi and ONSEMI are trademarks of Semiconductor Components Industries, LLC dba onsemi or its subsidiaries in the United States and/or other countries. onsemi reserves the right to make changes without further notice to any products herein. onsemi makes no warranty, representation or guarantee regarding the suitability of its products for any particular purpose, nor does onsemi assume any liability arising out of the application or use of any product or circuit, and specifically disclaims any and all liability, including without limitation special, consequential or incidental damages. onsemi does not convey any license under its patent rights nor the rights of others.

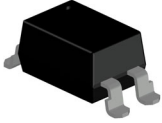

PDIP4 4.60x6.50x3.85, 2.54P
CASE 709AH
ISSUE B

DATE 06 JUL 2023

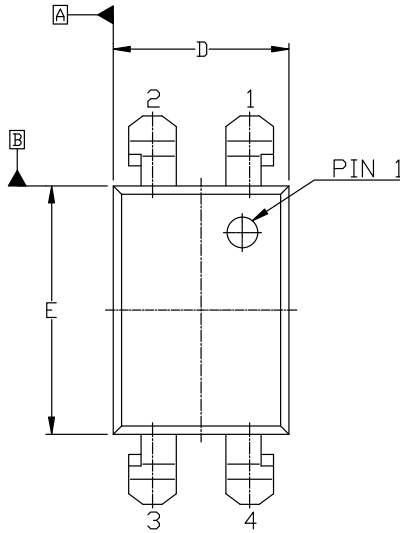

TOP VIEW

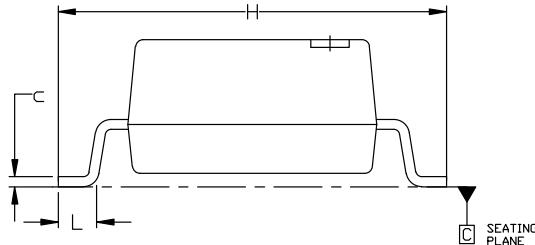

END VIEW

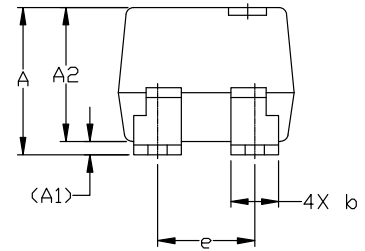

SIDE VIEW

NOTES:

1. DIMENSIONING AND TOLERANCING PER ASME Y14.5M, 1994.
2. CONTROLLING DIMENSION: MILLIMETERS.
3. DIMENSIONS ARE EXCLUSIVE OF BURRS, MOLD FLASH, AND TIE BAR EXTRUSION.
4. DRAWING FILENAME AND REVISION: MKT-N04Crev2.

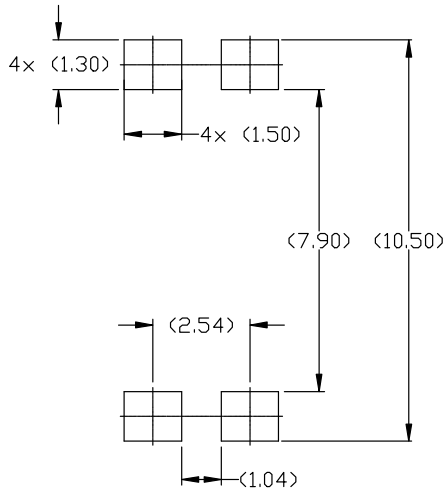

LAND PATTERN RECOMMENDATION

DIM	MILLIMETERS		
	MIN.	NOM.	MAX.
A	3.85 (TYP)		
A1	0.35 (REF)		
A2	3.00	3.50	4.00
b	1.15	1.25	1.35
c	0.26 (REF)		
D	4.10	4.60	5.10
E	6.00	6.50	7.00
e	2.29	2.54	2.79
H	9.86	10.16	10.46
L	0.75	---	1.25

* For additional information on our Pb-Free strategy and soldering details, please download the ON Semiconductor Soldering and Mounting Techniques Reference Manual, SOLDERM/D.

DOCUMENT NUMBER:	98AON13454G	Electronic versions are uncontrolled except when accessed directly from the Document Repository. Printed versions are uncontrolled except when stamped "CONTROLLED COPY" in red.
DESCRIPTION:	PDIP4 4.60x6.50x3.85, 2.54P	PAGE 1 OF 1

onsemi and ONSEMI are trademarks of Semiconductor Components Industries, LLC dba onsemi or its subsidiaries in the United States and/or other countries. onsemi reserves the right to make changes without further notice to any products herein. onsemi makes no warranty, representation or guarantee regarding the suitability of its products for any particular purpose, nor does onsemi assume any liability arising out of the application or use of any product or circuit, and specifically disclaims any and all liability, including without limitation special, consequential or incidental damages. onsemi does not convey any license under its patent rights nor the rights of others.

onsemi, **Onsemi**, and other names, marks, and brands are registered and/or common law trademarks of Semiconductor Components Industries, LLC dba "**onsemi**" or its affiliates and/or subsidiaries in the United States and/or other countries. **onsemi** owns the rights to a number of patents, trademarks, copyrights, trade secrets, and other intellectual property. A listing of **onsemi**'s product/patent coverage may be accessed at www.onsemi.com/site/pdf/Patent-Marking.pdf. **onsemi** reserves the right to make changes at any time to any products or information herein, without notice. The information herein is provided "as-is" and **onsemi** makes no warranty, representation or guarantee regarding the accuracy of the information, product features, availability, functionality, or suitability of its products for any particular purpose, nor does **onsemi** assume any liability arising out of the application or use of any product or circuit, and specifically disclaims any and all liability, including without limitation special, consequential or incidental damages. Buyer is responsible for its products and applications using **onsemi** products, including compliance with all laws, regulations and safety requirements or standards, regardless of any support or applications information provided by **onsemi**. "Typical" parameters which may be provided in **onsemi** data sheets and/or specifications can and do vary in different applications and actual performance may vary over time. All operating parameters, including "Typicals" must be validated for each customer application by customer's technical experts. **onsemi** does not convey any license under any of its intellectual property rights nor the rights of others. **onsemi** products are not designed, intended, or authorized for use as a critical component in life support systems or any FDA Class 3 medical devices or medical devices with a same or similar classification in a foreign jurisdiction or any devices intended for implantation in the human body. Should Buyer purchase or use **onsemi** products for any such unintended or unauthorized application, Buyer shall indemnify and hold **onsemi** and its officers, employees, subsidiaries, affiliates, and distributors harmless against all claims, costs, damages, and expenses, and reasonable attorney fees arising out of, directly or indirectly, any claim of personal injury or death associated with such unintended or unauthorized use, even if such claim alleges that **onsemi** was negligent regarding the design or manufacture of the part. **onsemi** is an Equal Opportunity/Affirmative Action Employer. This literature is subject to all applicable copyright laws and is not for resale in any manner.

ADDITIONAL INFORMATION

TECHNICAL PUBLICATIONS:

Technical Library: www.onsemi.com/design/resources/technical-documentation
onsemi Website: www.onsemi.com

ONLINE SUPPORT: www.onsemi.com/support

For additional information, please contact your local Sales Representative at www.onsemi.com/support/sales