

FTCO3V85A1

3-Phase Automotive Power Module for DC-DC Converter

General Description

The FTCO3V85A1 is an 80 V low Rds(on) automotive qualified power module, featuring a 3-phase MOSFET bridge optimized for Automotive 48 V–12 V interleaved DC–DC converter system, it includes a precision shunt resistor for current sensing, an NTC for temperature sensing, and an RC snubber circuit.

The module utilizes ON's trench MOSFET technology and it is designed to provide a very compact and high efficiency solution for DC–DC converter system. The Power module is 100% lead free, RoHS and UL compliant.

Features

- 3-Phase 1.5 kW 48 V–12 V Interleaved DC–DC Converter
- 80 V–125 A Trench MOSFET's for High-Side
80 V–160 A Trench MOSFET for Low-Side
- Precise Shunt Current Sensing
- Temperature Sensing
- DBC Substrate
- 100% Lead Free and RoHS Compliant 2000/53/C Directive
- UL94V–0 Compliant
- Isolation Rating of 2500 Vrms/min
- Mounting Through Screws
- Automotive Qualified

Benefits

- Low Junction–Sink Thermal Resistance
- Low Power Loss for High Efficiency in DC–DC System Design
- Low Electrical Resistance
- Compact DC–DC Converter Design
- Highly Integrated Compact Design
- Better EMI and Electrical Isolation
- Easy and Reliable Installation
- High Current Handling
- Improved Overall System Reliability

Applications

- DC–DC Converter



ON Semiconductor®

www.onsemi.com

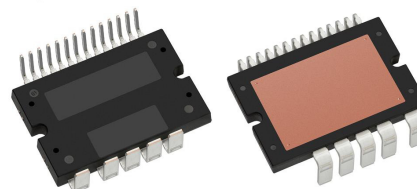

19LD, APM, PDD STD 9
(APM19–CBC)
CASE MODCD

MARKING DIAGRAM

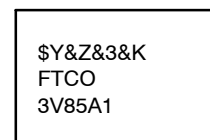

\$Y	= ON Semiconductor Logo
&Z	= Assembly Plant Code
&3	= Data Code (Year & Week)
&K	= Lot
FTCO3V85A1	= Specific Device Code

ORDERING INFORMATION

See detailed ordering and shipping information on page 13 of this data sheet.

FTCO3V85A1

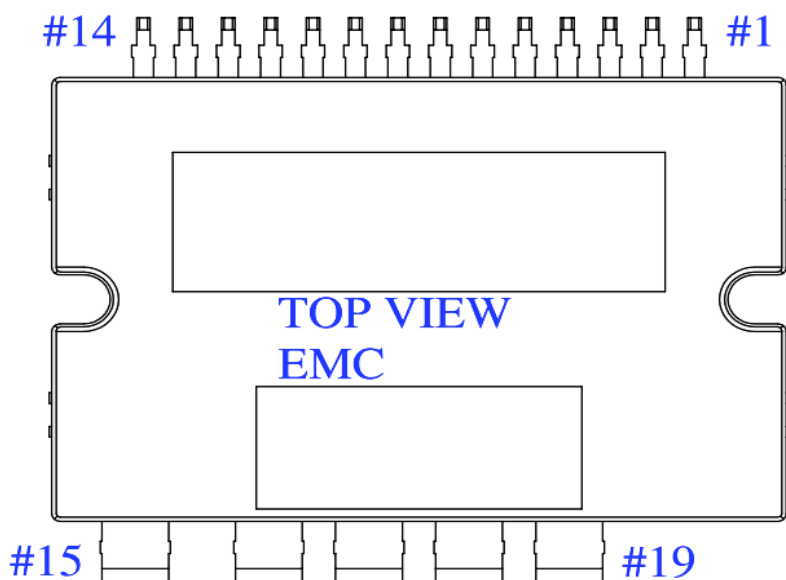

Figure 1. Pin Configuration

Table 1. PIN DESC

Pin No.	Pin Number	Pin Description
1	TEMP 1	NTC Thermistor Terminal 1
2	TEMP 2	NTC Thermistor Terminal 2
3	PHASE 3 SENSE	Source of Q3 and Drain of Q6
4	GATE 3	Gate of Q3, high side Phase 3 MOSFET
5	GATE 6	Gate of Q6, low side Phase 3 MOSFET
6	PHASE 2 SENSE	Source of Q2 and Drain of Q5
7	GATE 2	Gate of Q2, high side Phase 2 MOSFET
8	GATE 5	Gate of Q5, low side Phase 2 MOSFET
9	PHASE 1 SENSE	Source of Q1 and Drain of Q4
10	GATE 1	Gate of Q1, high side Phase 1 MOSFET
11	VBAT SENSE	Sense pin for battery voltage and Drain of high side MOSFETs
12	GATE 4	Gate of Q4, low side Phase 1 MOSFET
13	SHUNT P	Positive CSR sense pin and source connection for low side MOSFETs
14	SHUNT N	Negative CSR sense pin and sense pin for battery return
15	VBAT	Battery voltage power lead
16	GND	Battery return power lead
17	PHASE 1	Phase 1 power lead
18	PHASE 2	Phase 2 power lead
19	PHASE 3	Phase 3 power lead

FTCO3V85A1

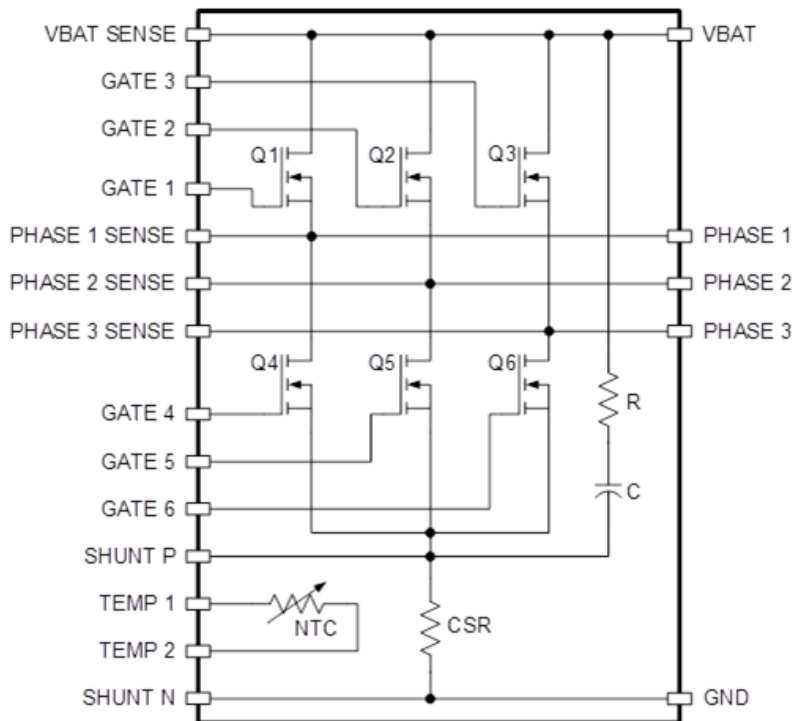

Figure 2. Internal Equivalent Circuit

Flammability Information

All materials present in the power module meet UL flammability rating class 94V-0 or higher.

Compliance to RoHS

The Power Module is 100% lead free and RoHS compliant with the 2000/53/C directive.

Solder

Solder used is a lead free SnAgCu alloy.

FTCO3V85A1

ABSOLUTE MAXIMUM RATINGS (T_C = 25°C, Unless otherwise specified)

Symbol	Parameter	FTCO3V85A1	Unit
V _{DS} (Q1–Q6)	Drain to Source Voltage	80	V
V _{GS} (Q1–Q6)	Gate to Source Voltage	±20	V
I _D (high-side)	Drain Current Continuous (T _C = 25°C, T _J = 175°C, V _{GS} = 10 V) (Note 1)	125	A
I _D (low-side)	Drain Current Continuous (T _C = 25°C, T _J = 175°C, V _{GS} = 10 V) (Note 1)	160	A
E _{AS} (Q1–Q3)	Single Pulse Avalanche Energy (Note 2)	190	mJ
E _{AS} (Q4–Q6)	Single Pulse Avalanche Energy (Note 2)	324	mJ
P _D (high-side)	Power dissipation (T _C = 25°C, T _J = 175°C)	115	W
P _D (low-side)	Power dissipation (T _C = 25°C, T _J = 175°C)	135	W
T _J	Maximum Junction Temperature	175	°C
T _{STG}	Storage Temperature	125	°C

THERMAL RESISTANCE

Symbol	Parameter	Min.	Typ.	Max.	Unit
R _{thjc} Thermal Resistance Junction to case, Single FET, (Note 3)	Q1 Thermal Resistance J –C	–	1.0	1.3	°C/W
	Q2 Thermal Resistance J –C	–	1.0	1.3	°C/W
	Q3 Thermal Resistance J –C	–	1.0	1.3	°C/W
	Q4 Thermal Resistance J –C	–	0.8	1.1	°C/W
	Q5 Thermal Resistance J –C	–	0.8	1.1	°C/W
	Q6 Thermal Resistance J –C	–	0.8	1.1	°C/W
T _J	Maximum Junction Temperature	–		175	°C
T _S	Operating Sink Temperature	–40		120	°C
T _{STG}	Storage Temperature	–40		125	°C

1. Max value not to exceed T_J=175°C based on max limitation of R_{thjc} thermal limitation and R_{ds(on)}. Defined by design, not subject production testing.
2. For Q1–Q3: Starting T_J = 25°C, L = 0.08mH, I_{AS} = 69 A, V_{DD} = 80 V during inductor charging and V_{DD} = 0 V during time in avalanche. For Q4–Q6: Starting T_J = 25°C, L = 0.08 mH, I_{AS} = 90 A, V_{DD} = 80 V during inductor charging and V_{DD} = 0 V during time in avalanche.
3. Test method compliant with MIL STD 883–1012.1.

FTCO3V85A1

ELECTRICAL CHARACTERISTICS (T_C = 25°C unless otherwise noted)

Symbol	Parameter	Test Conditions	Min.	Typ.	Max.	Unit
BV _{DSS}	D-S Breakdown Voltage (Inverter MOSFETs)	V _{GS} = 0V, I _D = 250 μA	80	-	-	V
V _{GS}	Gate to Source Voltage (Inverter MOSFETs)	Gate-to-Source Voltage	-20	-	20	V
V _{TH}	Threshold Voltage (Q1-Q6)	V _{GS} = V _{DS} , I _D = 250 μA, T _J = 25°C	2	3	4	V
V _{SD}	MOSFET Body Diode Forward Voltage	V _{GS} = 0 V, I _S = 80 A, T _J = 25°C	-	-	1	V
R _{DS(ON)Q1}	Inverter High Side MOSFETs Q1 (See Note 4)	V _{GS} = 10 V, I _D = 80 A, T _J = 25°C	-	2.4	3.5	mΩ
R _{DS(ON)Q2}	Inverter High Side MOSFETs Q2 (See Note 4)	V _{GS} = 10 V, I _D = 80 A, T _J = 25°C	-	2.4	3.5	mΩ
R _{DS(ON)Q3}	Inverter High Side MOSFETs Q3 (See Note 4)	V _{GS} = 10 V, I _D = 80 A, T _J = 25°C	-	2.5	3.7	mΩ
R _{DS(ON)Q4}	Inverter Low Side MOSFETs Q4 (See Note 4)	V _{GS} = 10 V, I _D = 80 A, T _J = 25°C	-	1.9	2.6	mΩ
R _{DS(ON)Q5}	Inverter Low Side MOSFETs Q5 (See Note 4)	V _{GS} = 10 V, I _D = 80 A, T _J = 25°C	-	2.1	2.8	mΩ
R _{DS(ON)Q6}	Inverter Low Side MOSFETs Q6 (See Note 4)	V _{GS} = 10 V, I _D = 80 A, T _J = 25°C	-	2.4	3.1	mΩ
I _{GSS}	Inverter MOSFETs (UH,UL,VH,VL,WH,WL)	V _{GS} = ±20 V, V _{DS} = 0 V, T _J = 25°C	-	-	±100	nA
I _{DSS}	Inverter MOSFETs Drain to Source Leakage Current	V _{GS} = 0 V, V _{DS} = 80 V, T _J = 25°C	-	-	2	μA
Total loop resistance VLINK(+) - V0 (-)		V _{GS} = 10 V, I _D = 80 A, T _J = 25°C	-	5.9	7.5	mΩ

Product parametric performance is indicated in the Electrical Characteristics for the listed test conditions, unless otherwise noted. Product performance may not be indicated by the Electrical Characteristics if operated under different conditions.

4. High side Q1,Q2,Q3 have same die size and Rdson, Low side Q4,Q5,Q6 have same die size and Rdson. For lowest power loss, High and Low side MOSFETs have different die size and Rdson. The different Rdson values listed in the datasheet are due to the different access points available inside the module for Rdson measurement. While the high side MOSFETs (Q1, Q2, Q3) have source sense wire bonds, the low side MOSFETs (Q4, Q5, Q6) do not have source sense wire bonds, thus resulting in higher Rdson values.

TEMPERATURE SENSE (NTC THERMISTOR)

Symbol	Test Conditions	Min.	Typ.	Max.	Unit
Voltage	Current = 1 mA, Temperature = 25°C	7.5	-	12	V

CURRENT SENSE RESISTOR

Symbol	Test Conditions	Min.	Typ.	Max.	Unit
Voltage	Current sense resistor current = 80 A (Note 5)	0.47	-	0.51	mΩ

	Components	Spec	Quantity	Size
1	MOSFET	PT7 80 V,bare die Rdson 2.25 mΩ typical	3ea (Q1-Q3)	195 mil x 95 mil
2	MOSFET	PT7 80 V,bare die Rdson 1.35 mΩ typical	3ea (Q4-Q6)	200 mil x 145 mil
3	Resistor	1 Ω 0.5 W	1ea	142 mil x 55 mil
4	Capacitor	0.022 μF 100 V	1ea	79 mil x 49 mil
5	CSR	1% tolerance, 0.5 mΩ	1ea	250 mil x 120 mil
6	NTC	1% tolerance, 10 kΩ	1ea	63 mil x 32 mil

FTCO3V85A1

DYNAMIC CHARACTERISTIC

Symbol	Parameter	Min	Test Conditions	Min.	Typ.	Max.	Unit
C_{iss}	Input Capacitance		$V_{DS} = 40\text{ V}, V_{GS} = 0\text{ V},$ $f = 1\text{ MHz}$ for Q1–Q3 (High side MOSFET)	–	6320	–	pF
C_{oss}	Output Capacitance			–	1030	–	pF
C_{rss}	Reverse Transfer Capacitance			–	32	–	pF
C_{iss}	Input Capacitance		$V_{DS} = 40\text{ V}, V_{GS} = 0\text{ V},$ $f = 1\text{ MHz}$ for Q4–Q6 (Low side MOSFET)	–	10000	–	pF
C_{oss}	Output Capacitance			–	1400	–	pF
C_{rss}	Reverse Transfer Capacitance			–	95	–	pF
R_G	Gate Resistance		$V_{GS} = 0\text{ V}, f = 1\text{ MHz}$ for Q1–Q3 (High side MOSFET)	–	2.1	–	Ω
R_G	Gate Resistance		$V_{GS} = 0\text{ V}, f = 1\text{ MHz}$ for Q4–Q6 (Low side MOSFET)	–	3.3	–	Ω
$Q_{g(TOT)}$	Total Gate Charge at 10 V	$V_{GS} = 0\text{ to }10\text{ V}$	$V_{DD} = 64\text{ V}$ $I_D = 80\text{ A}$ $I_g = 1\text{ mA}$	–	86	112	nC
$Q_{g(TH)}$	Threshold Gate Charge	$V_{GS} = 0\text{ to }2\text{ V}$		–	12	18	nC
Q_{gs}	Gate to Source Gate Charge	For Q1–Q3 (High side MOSFET)		–	30	–	nC
Q_{gd}	Gate to Drain “Miller” Charge			–	18	–	nC
$Q_{g(TOT)}$	Total Gate Charge at 10 V	$V_{GS} = 0\text{ to }10\text{ V}$	$V_{DD} = 64\text{ V}$ $I_D = 80\text{ A}$ $I_g = 1\text{ mA}$	–	131	150	nC
$Q_{g(TH)}$	Threshold Gate Charge	$V_{GS} = 0\text{ to }2\text{ V}$		–	18	21	nC
Q_{gs}	Gate to Source Gate Charge	For Q4–Q6 (Low side MOSFET)		–	47	–	nC
Q_{gd}	Gate to Drain “Miller” Charge			–	24	–	nC

FTCO3V85A1

TYPICAL CHARACTERISTICS

(The dynamic, switching characteristics and Graphs are in reference to the FDBL86366_F085 (TOLL) Datasheet (High side MOSFET))

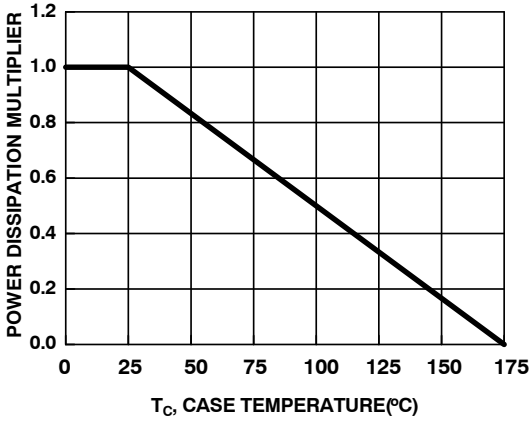

Figure 3. Normalized Power Dissipation vs. Case Temperature

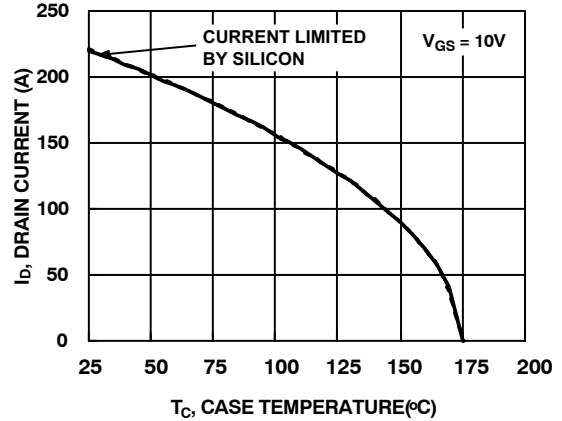

Figure 4. Maximum Continuous Drain Current vs. Case Temperature

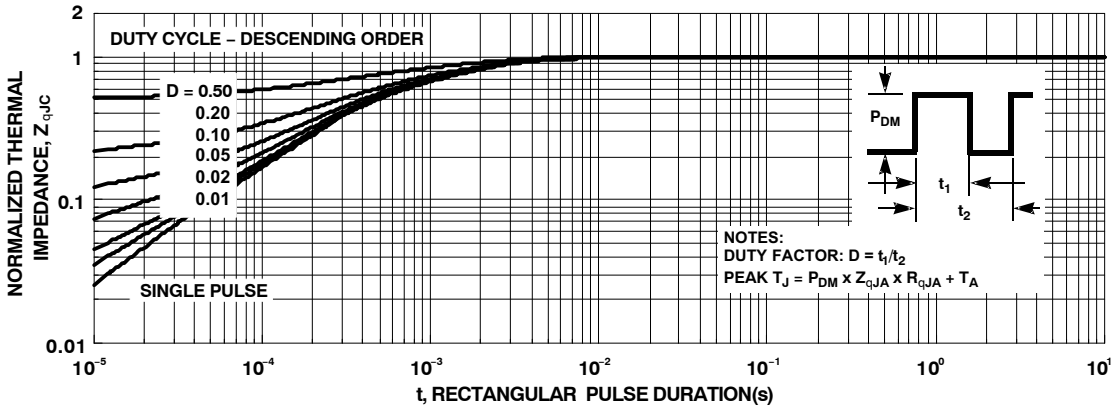

Figure 5. Normalized Maximum Transient Thermal Impedance

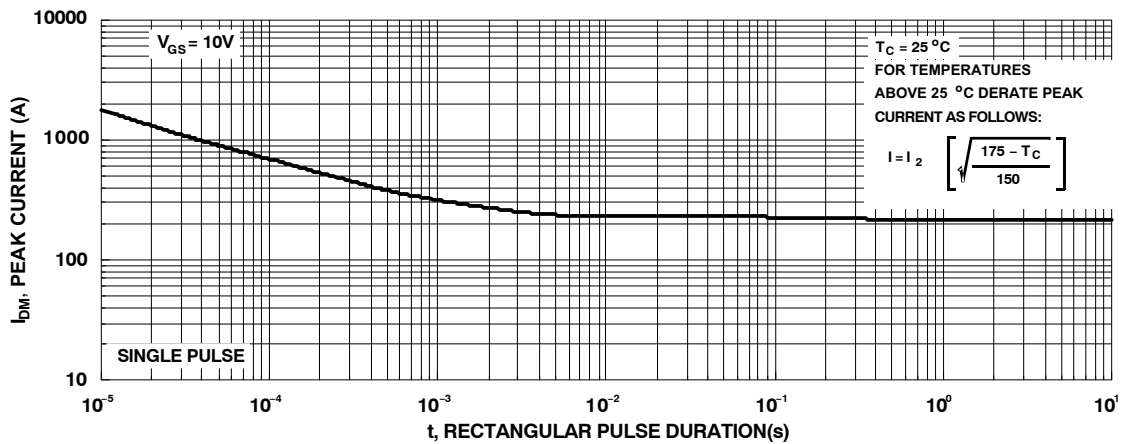

Figure 6. Peak Current Capability

TYPICAL CHARACTERISTICS

(The dynamic, switching characteristics and Graphs are in reference to the FDBL86366_F085 (TOLL) Datasheet (High side MOSFET)
(Continued)

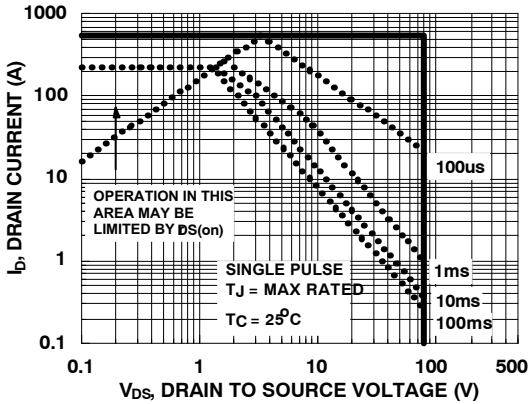

Figure 7. Forward Bias Safe Operating Area

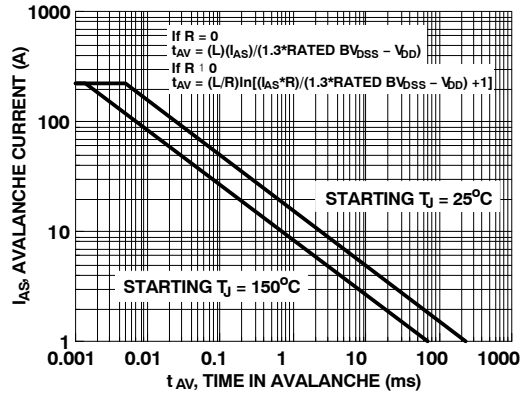

Figure 8. Unclamped Inductive Switching Capability

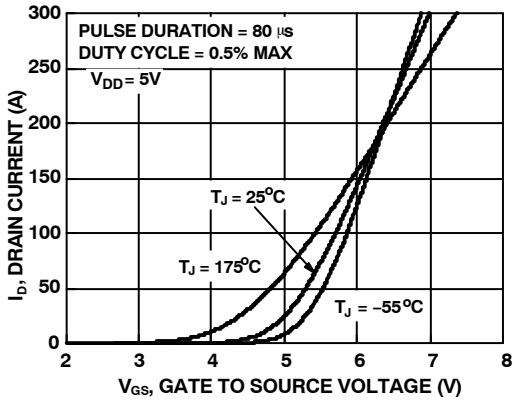

Figure 9. Transfer Characteristics

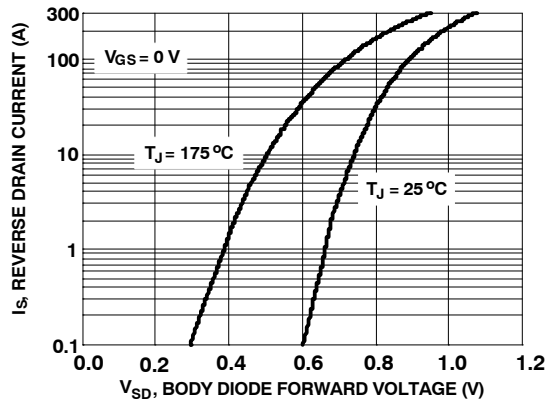

Figure 10. Forward Diode Characteristics

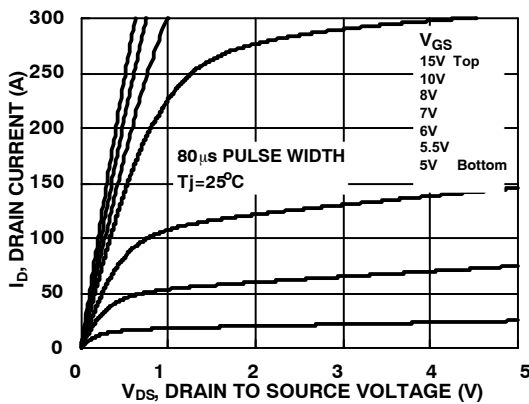

Figure 11. Saturation Characteristics

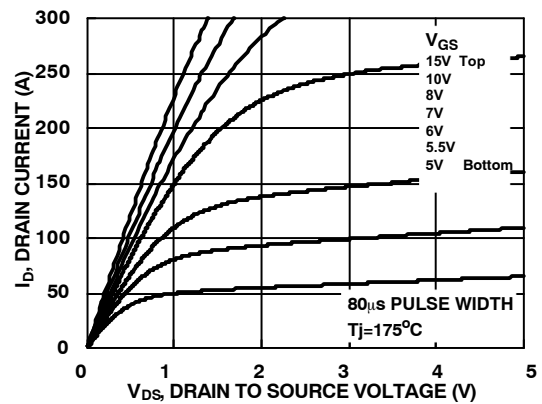

Figure 12. Saturation Characteristics

TYPICAL CHARACTERISTICS

(The dynamic, switching characteristics and Graphs are in reference to the FDBL86366_F085 (TOLL) Datasheet (High side MOSFET)
(Continued)

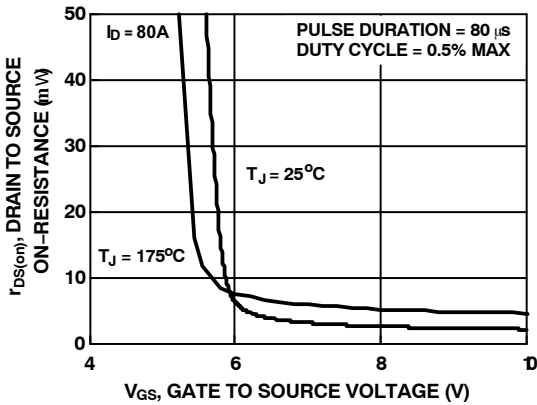

Figure 13. $R_{DS(on)}$ vs. Gate Voltage

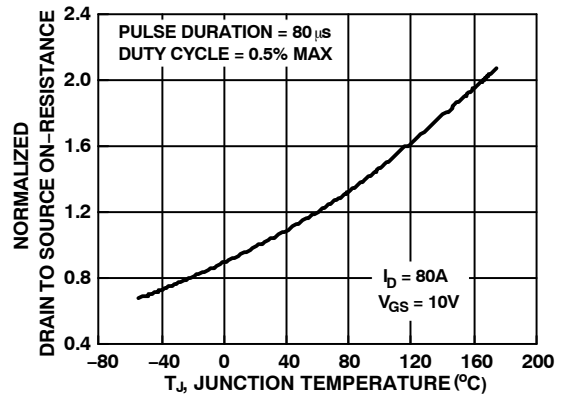

Figure 14. Normalized $R_{DS(on)}$ vs. Junction Temperature

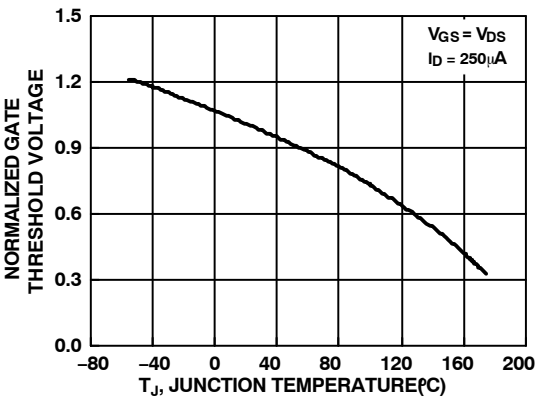

Figure 15. Normalized Gate Threshold Voltage vs. Temperature

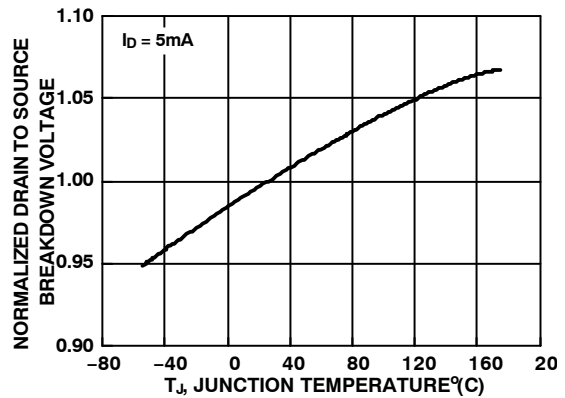

Figure 16. Normalized Drain to Source Breakdown Voltage vs. Junction Temperature

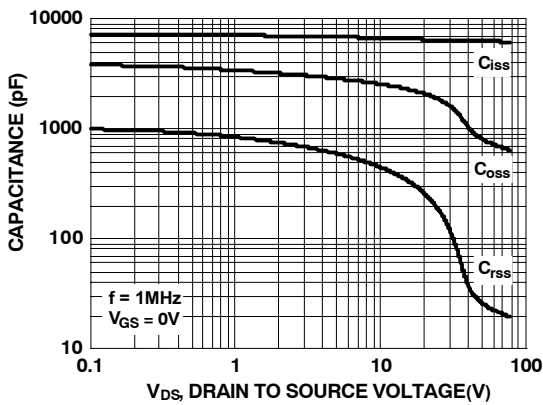

Figure 17. Capacitance vs. Drain to Source Voltage

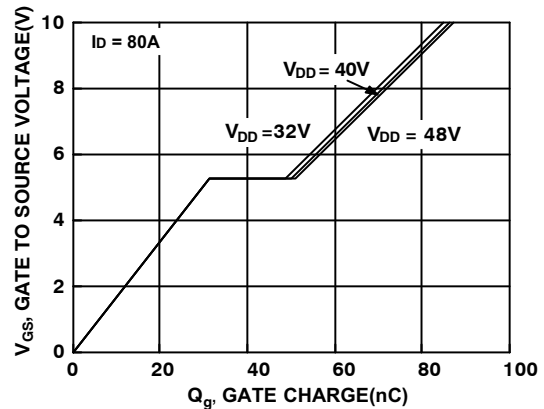

Figure 18. Gate Charge vs. Gate to Source Voltage

FTCO3V85A1

TYPICAL CHARACTERISTICS

(The dynamic, switching characteristics and Graphs are in reference to the FDBL86363_F085 (TOLL) Datasheet (Low side MOSFET)
(Continued)

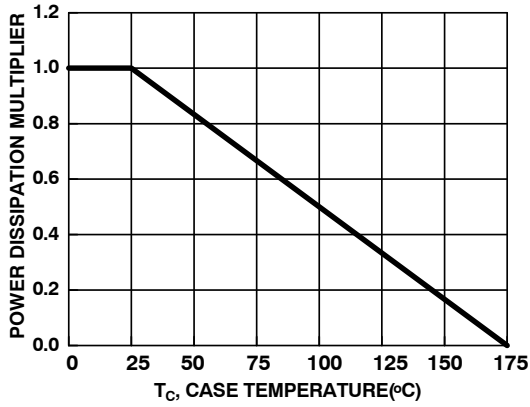

Figure 19. Normalized Power Dissipation vs. Case Temperature

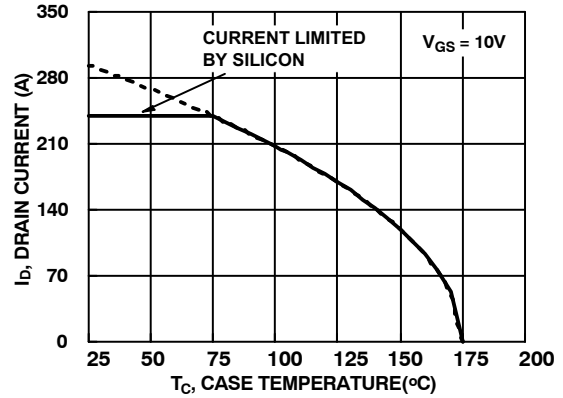

Figure 20. Maximum Continuous Drain Current vs. Case Temperature

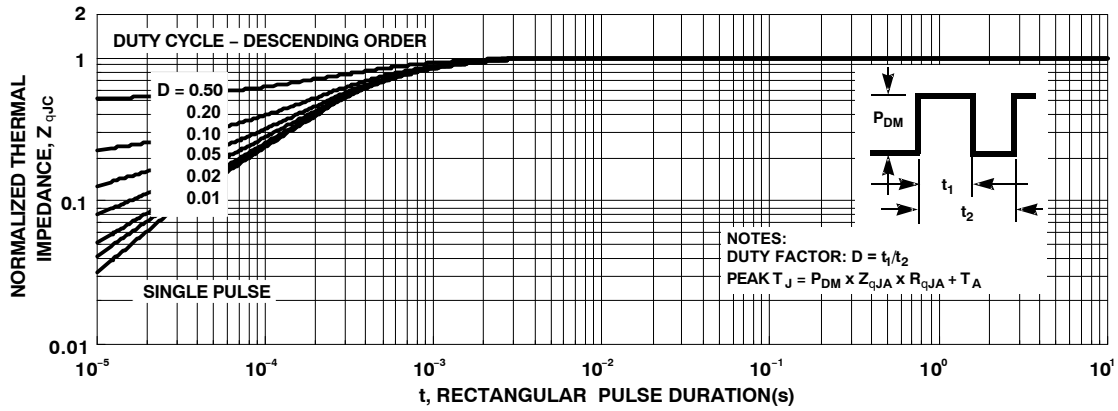

Figure 21. Normalized Maximum Transient Thermal Impedance

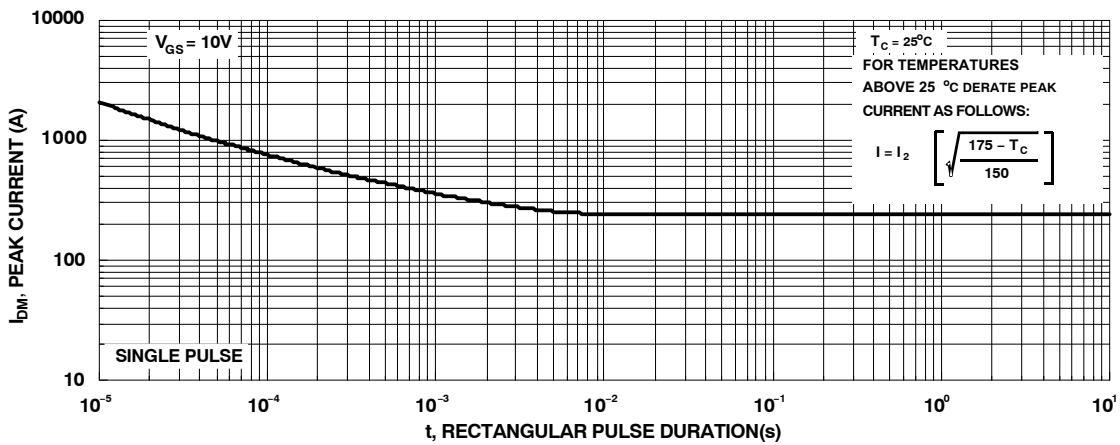

Figure 22. Peak Current Capability

TYPICAL CHARACTERISTICS

(The dynamic, switching characteristics and Graphs are in reference to the FDBL86363_F085 (TOLL) Datasheet (Low side MOSFET)
(Continued)

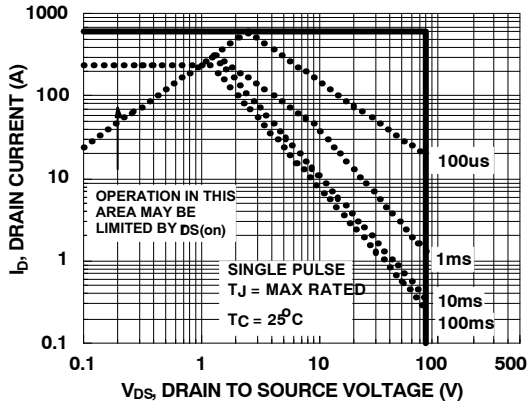

Figure 23. Forward Bias Safe Operating Area

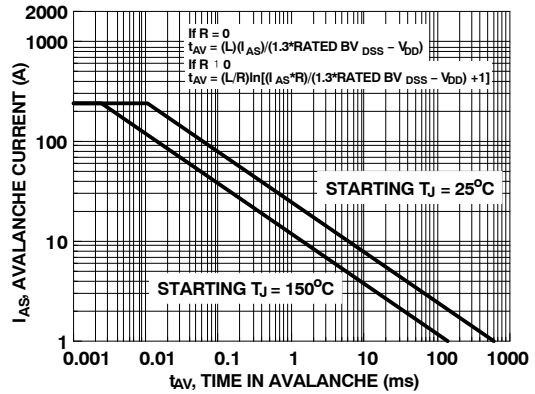

Figure 24. Unclamped Inductive Switching Capability

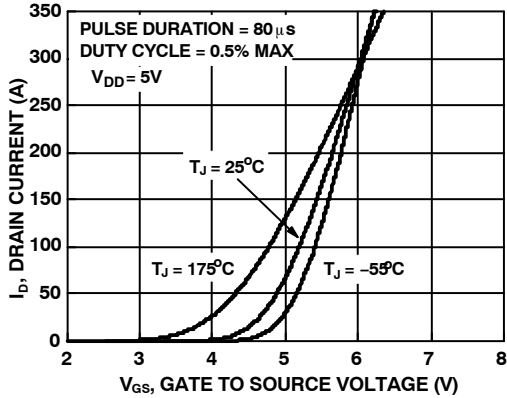

Figure 25. Transfer Characteristics

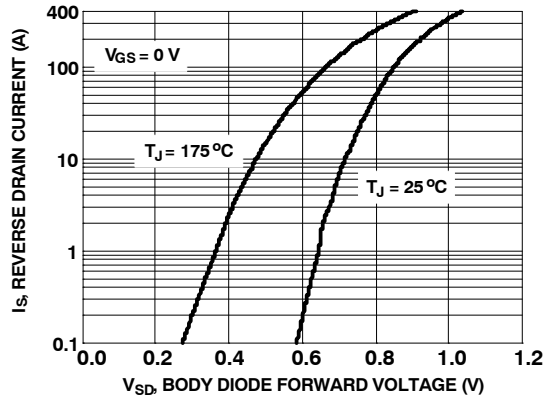

Figure 26. Forward Diode Characteristics

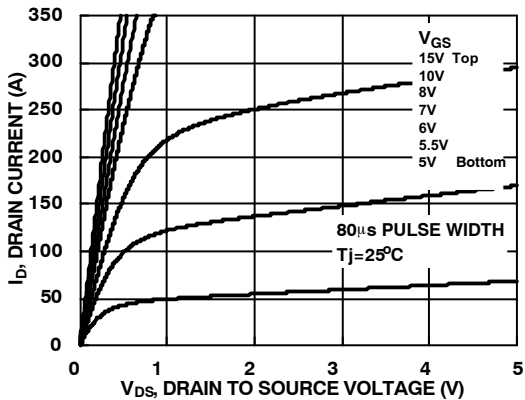

Figure 27. Saturation Characteristics

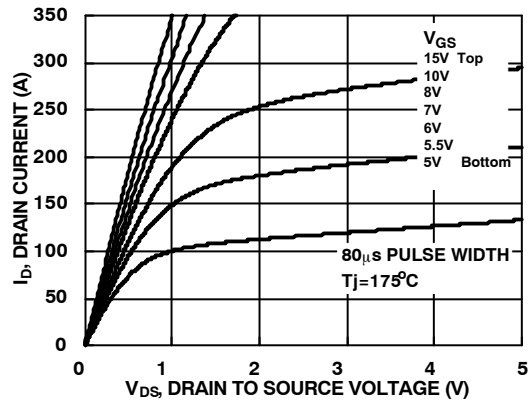

Figure 28. Saturation Characteristics

FTCO3V85A1

TYPICAL PERFORMANCE CHARACTERISTICS

(The dynamic, switching characteristics and Graphs are in reference to the FDBL86363_F085 (TOLL) Datasheet (Low side MOSFET)
(Continued)

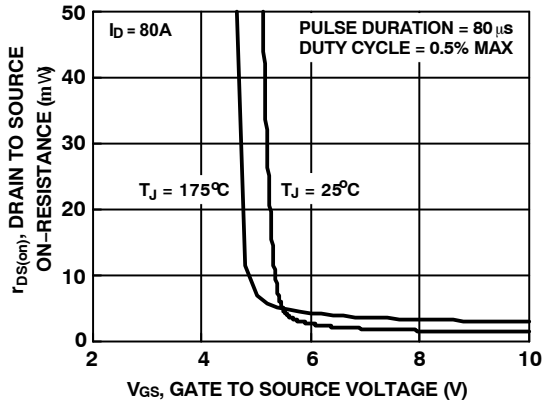

Figure 29. $R_{DS(on)}$ vs. Gate Voltage

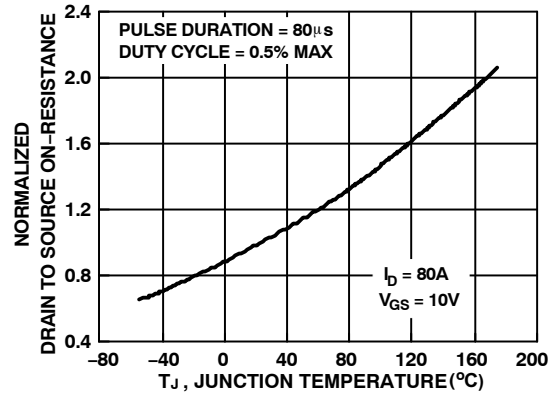

Figure 30. Normalized $R_{DS(on)}$ vs. Junction Temperature

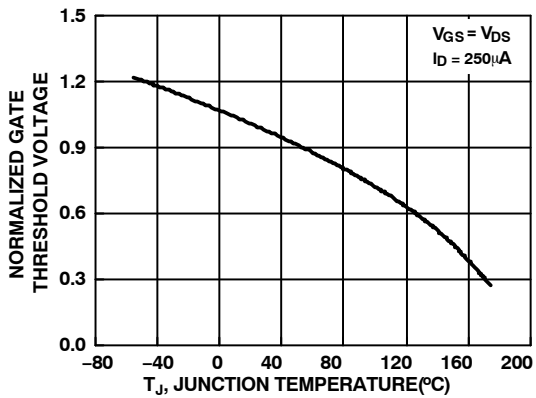

Figure 31. Normalized Gate Threshold Voltage vs. Temperature

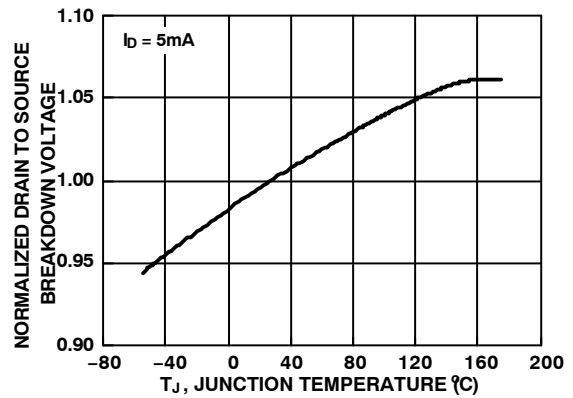

Figure 32. Normalized Drain to Source Breakdown Voltage vs. Junction Temperature

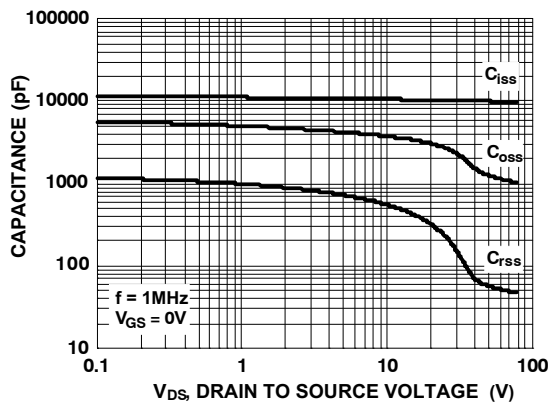

Figure 33. Capacitance vs. Drain to Source Voltage

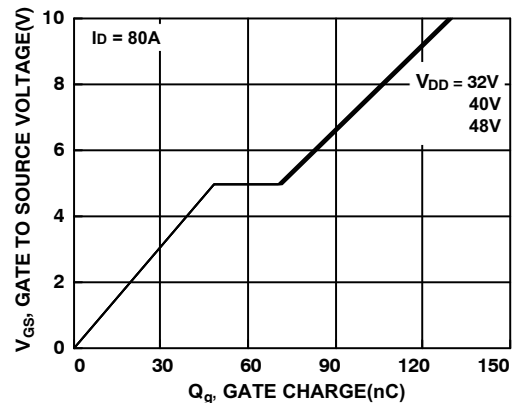
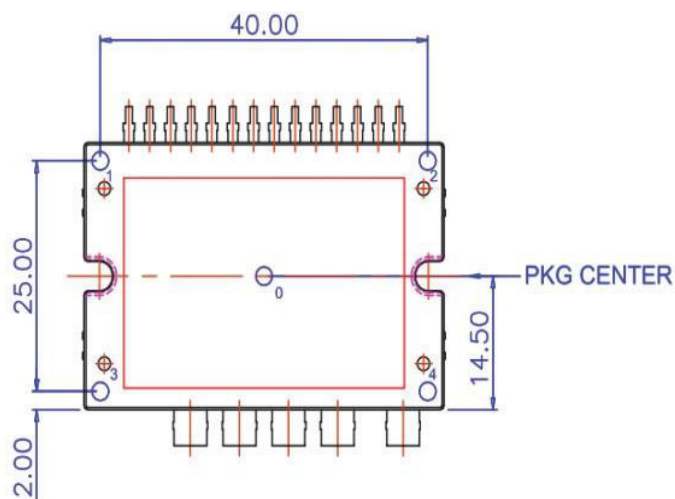

Figure 34. Gate Charge vs. Gate to Source Voltage

FTCO3V85A1

Table 2. MECHANICAL CHARACTERISTICS AND RATINGS

Parameter	Condition	Limits			Units
		Min.	Typ.	Max.	
Device Flatness	Note Fig. 15	0	-	+150	μm
Mounting Torque	Mounting Screw: -M3, Recommended 0.7N.m	0.4	-	0.8	N.m
Weight		-	20	-	g



FLATNESS : MAX. 150μm

- MEASURING AT INDICATING POINTS
1, 2, 3, AND 4 (BASED ON "0")

Table 3. PACKAGE MARKING AND ORDERING INFORMATION

Device Marking	Packing Type	Quantity
FTCO3V85A1	Tube	11

MECHANICAL CASE OUTLINE

PACKAGE DIMENSIONS

ON Semiconductor®



19LD, APM, PDD STD (APM19-CBC) CASE MODCD ISSUE O

DATE 30 NOV 2016

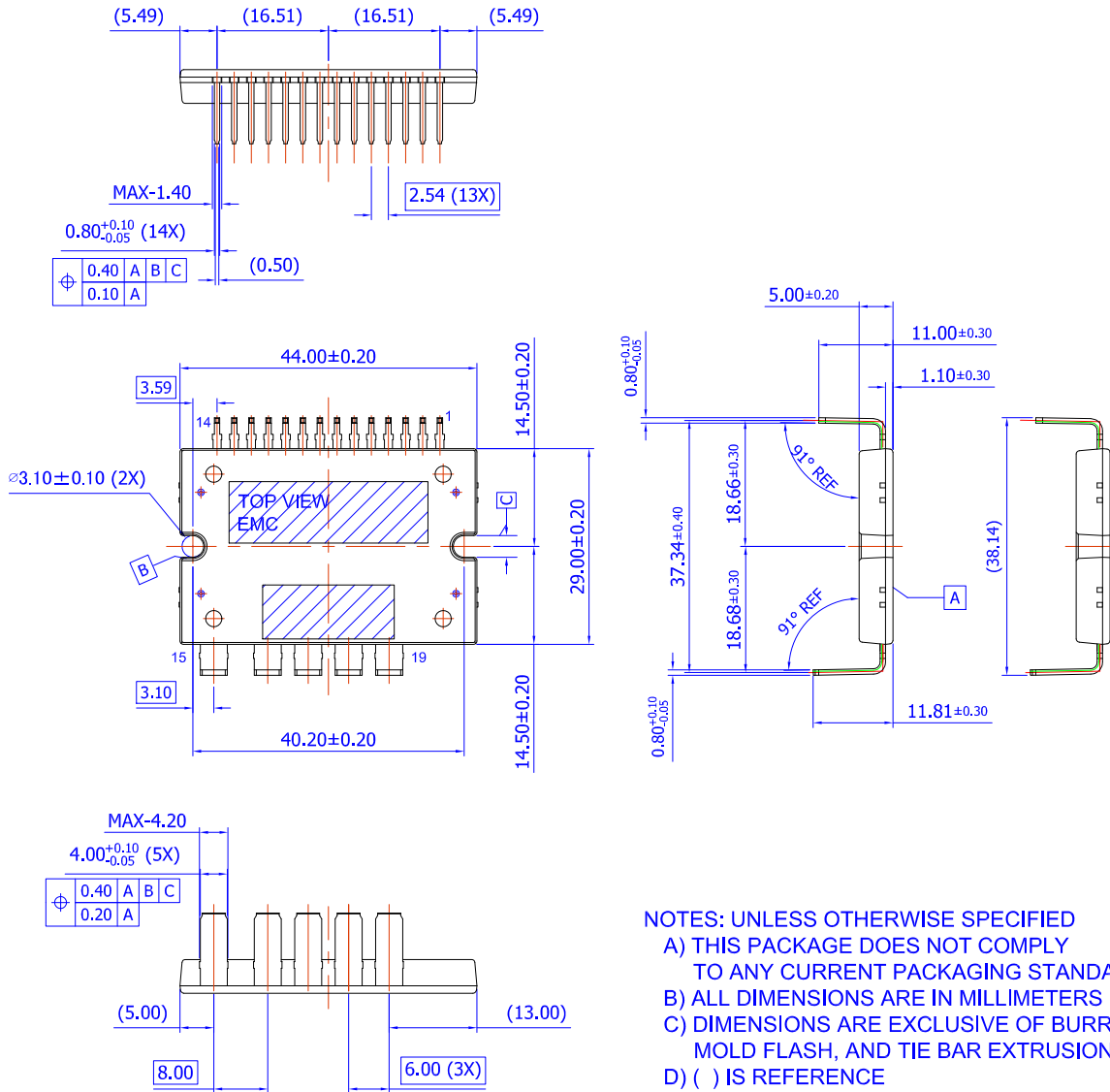

DOCUMENT NUMBER:	98AON13505G	Electronic versions are uncontrolled except when accessed directly from the Document Repository. Printed versions are uncontrolled except when stamped "CONTROLLED COPY" in red.
DESCRIPTION:	19LD, APM, PDD STD (APM19-CBC)	PAGE 1 OF 1

ON Semiconductor and are trademarks of Semiconductor Components Industries, LLC dba ON Semiconductor or its subsidiaries in the United States and/or other countries. ON Semiconductor reserves the right to make changes without further notice to any products herein. ON Semiconductor makes no warranty, representation or guarantee regarding the suitability of its products for any particular purpose, nor does ON Semiconductor assume any liability arising out of the application or use of any product or circuit, and specifically disclaims any and all liability, including without limitation special, consequential or incidental damages. ON Semiconductor does not convey any license under its patent rights nor the rights of others.

onsemi, **Onsemi**, and other names, marks, and brands are registered and/or common law trademarks of Semiconductor Components Industries, LLC dba "**onsemi**" or its affiliates and/or subsidiaries in the United States and/or other countries. **onsemi** owns the rights to a number of patents, trademarks, copyrights, trade secrets, and other intellectual property. A listing of **onsemi**'s product/patent coverage may be accessed at www.onsemi.com/site/pdf/Patent-Marking.pdf. **onsemi** reserves the right to make changes at any time to any products or information herein, without notice. The information herein is provided "as-is" and **onsemi** makes no warranty, representation or guarantee regarding the accuracy of the information, product features, availability, functionality, or suitability of its products for any particular purpose, nor does **onsemi** assume any liability arising out of the application or use of any product or circuit, and specifically disclaims any and all liability, including without limitation special, consequential or incidental damages. Buyer is responsible for its products and applications using **onsemi** products, including compliance with all laws, regulations and safety requirements or standards, regardless of any support or applications information provided by **onsemi**. "Typical" parameters which may be provided in **onsemi** data sheets and/or specifications can and do vary in different applications and actual performance may vary over time. All operating parameters, including "Typicals" must be validated for each customer application by customer's technical experts. **onsemi** does not convey any license under any of its intellectual property rights nor the rights of others. **onsemi** products are not designed, intended, or authorized for use as a critical component in life support systems or any FDA Class 3 medical devices or medical devices with a same or similar classification in a foreign jurisdiction or any devices intended for implantation in the human body. Should Buyer purchase or use **onsemi** products for any such unintended or unauthorized application, Buyer shall indemnify and hold **onsemi** and its officers, employees, subsidiaries, affiliates, and distributors harmless against all claims, costs, damages, and expenses, and reasonable attorney fees arising out of, directly or indirectly, any claim of personal injury or death associated with such unintended or unauthorized use, even if such claim alleges that **onsemi** was negligent regarding the design or manufacture of the part. **onsemi** is an Equal Opportunity/Affirmative Action Employer. This literature is subject to all applicable copyright laws and is not for resale in any manner.

ADDITIONAL INFORMATION

TECHNICAL PUBLICATIONS:

Technical Library: www.onsemi.com/design/resources/technical-documentation
onsemi Website: www.onsemi.com

ONLINE SUPPORT: www.onsemi.com/support

For additional information, please contact your local Sales Representative at www.onsemi.com/support/sales