

# Low Input Current High Gain Split Darlington Optocouplers

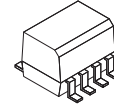

SOIC8  
CASE 751DZ

**Single Channel: HCPL0700, HCPL0701,**  
**Dual Channel: HCPL0731**

## HCPL0700, HCPL0701, HCPL0731

### Description

The HCPL0700, HCPL0701 and HCPL0731 optocouplers consist of an AlGaAs LED optically coupled to a high gain split darlington photodetector housed in a compact 8-pin small outline package. The HCPL0731 device have two channels per package for optimum mounting density.

The split darlington configuration separating the input photodiode and the first stage gain from the output transistor permits lower output saturation voltage and higher speed operation than possible with conventional darlington phototransistor optocoupler.

The combination of a very low input current of 0.5 mA and a high current transfer ratio of 2000% makes this family particularly useful for input interface to MOS, CMOS, LSTTL and EIA RS232C, while output compatibility is ensured to CMOS as well as high fan-out TTL requirements.

### Features

- Low input current: 0.5 mA
- Superior CTR: 2000%
- Superior CMR – 10 kV/μs
- CTR guaranteed 0°C to 70°C
- U.L. Recognized (file# E90700)
- VDE 0884 recognized (file# 136616)
- BSI recognized (file# 8661, 8662)  
– HCPL0700/0701 only
- These are Pb-Free Devices

### Applications

- Digital Logic Ground Isolation
- Telephone Ring Detector
- EIA-RS-232C Line Receiver
- High Common Mode Noise Line Receiver
- μP Bus Isolation
- Current Loop Receiver

### MARKING DIAGRAM



- XXX = Specific Device Code  
XXX = 700, 701, 731
- V = VDE Mark (only appears on parts ordered with VDE option)
- X = Year Code
- YY = Work Week
- S = Assembly Package Code

### ORDERING INFORMATION

See detailed ordering and shipping information on page 9 of this data sheet.

# HCPL0700, HCPL0701, HCPL0731

## SCHEMATICS

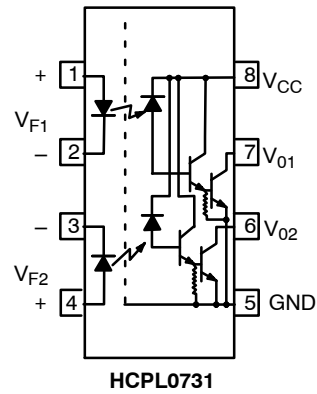
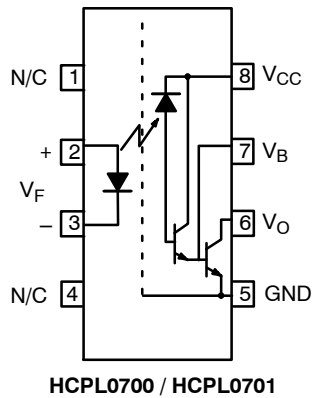

### TRUTH TABLE

LED	V <sub>O</sub>
ON	LOW
OFF	HIGH

### ABSOLUTE MAXIMUM RATINGS (T<sub>A</sub> = 25°C unless otherwise noted)

Symbol	Rating	Value	Unit
T <sub>STG</sub>	Storage Temperature	-40 to +125	°C
T <sub>OPR</sub>	Operating Temperature	-40 to +85	°C
	Reflow Temperature Profile (Refer to page 9)		

### EMITTER

I <sub>F</sub> (avg)	DC/Average Forward Input Current	20	mA
I <sub>F</sub> (pk)	Peak Forward Input Current (50% duty cycle, 1 ms P.W.)	40	mA
I <sub>F</sub> (trans)	Peak Transient Input Current - (≤1 μs P.W., 300 pps)	1.0	A
V <sub>R</sub>	Reverse Input Voltage	5	V
P <sub>D</sub>	Input Power Dissipation	35	mW

### DETECTOR

I <sub>O</sub> (avg)	Average Output Current (Pin 6)	60	mA	
V <sub>EBR</sub>	Emitter-Base Reverse Voltage	HCPL0700/HCPL0701	0.5	V
V <sub>CC</sub> , V <sub>O</sub>	Supply Voltage, Output Voltage	HCPL0700	-0.5 to 7	V
		HCPL0701/HCPL0731	-0.5 to 18	
P <sub>D</sub>	Output Power Dissipation		100	mW

Stresses exceeding those listed in the Maximum Ratings table may damage the device. If any of these limits are exceeded, device functionality should not be assumed, damage may occur and reliability may be affected.

# HCPL0700, HCPL0701, HCPL0731

## ELECTRICAL CHARACTERISTICS ( $T_A = 0$ to $70^\circ\text{C}$ unless otherwise noted)

Symbol	Parameter	Test Condition	Device	Min	Typ*	Max	Unit	
<b>INDIVIDUAL COMPONENT CHARACTERISTICS</b>								
<b>EMITTER</b>								
$V_F$	Input Forward Voltage	$I_F = 1.6 \text{ mA}$	$T_A = 25^\circ\text{C}$	HCPL0700/01	1.0	1.25	1.7	V
				HCPL0731		1.35		
			All	–	–	1.75		
$BV_R$	Input Reverse breakdown Voltage	$T_A = 25^\circ\text{C}, I_R = 10 \mu\text{A}$	All	5.0	–	–	V	
<b>DETECTOR</b>								
$I_{OH}$	Logic High Output Current	$I_F = 0 \text{ mA}, V_O = V_{CC} = 18 \text{ V}$	HCPL0701/31	–	0.01	100	$\mu\text{A}$	
		$I_F = 0 \text{ mA}, V_O = V_{CC} = 7 \text{ V}$	HCPL0700	–	0.01	250		
$I_{CCL}$	Logic Low Supply Current	$I_F = 1.6 \text{ mA}, V_O = \text{Open}, V_{CC} = 18 \text{ V}$	HCPL0700/01	–	0.4	1.5	mA	
		$V_{O1} = V_{O2} = \text{Open}, V_{CC} = 18 \text{ V}$	HCPL0731	–	1	–		
$I_{CCH}$	Logic High Supply Current	$I_F = 0 \text{ mA}, V_O = \text{Open}, V_{CC} = 18 \text{ V}$	HCPL0700/01	–	–	10	$\mu\text{A}$	
		$V_{O1} = V_{O2} = \text{Open}, V_{CC} = 18 \text{ V}$	HCPL0731	–	0.01	–		
<b>TRANSFER CHARACTERISTICS</b>								
CTR	COUPLED	$I_F = 0.5 \text{ mA}, V_O = 0.4 \text{ V}, V_{CC} = 4.5 \text{ V}$	HCPL0700/31	400	–	5000	%	
	Current Transfer Ratio (Notes 1, 2)	$I_F = 1.6 \text{ mA}, V_O = 0.4 \text{ V}, V_{CC} = 4.5 \text{ V}$	HCPL0700	300	–	2600		
			HCPL0701	500	–	2600		
			HCPL0731	500	–	5000		
$V_{OL}$	Logic Low Output Voltage	$I_F = 0.5 \text{ mA}, I_O = 2 \text{ mA}, V_{CC} = 4.5 \text{ V}$	HCPL0701	–	–	0.4	V	
		$I_F = 1.6 \text{ mA}, I_O = 8 \text{ mA}, V_{CC} = 4.5 \text{ V}$	HCPL0731	–	–	0.4		
		$I_F = 5 \text{ mA}, I_O = 15 \text{ mA}, V_{CC} = 4.5 \text{ V}$		–	–	0.4		
		$I_F = 12 \text{ mA}, I_O = 24 \text{ mA}, V_{CC} = 4.5 \text{ V}$		–	–	0.4		
		$I_F = 1.6 \text{ mA}, I_O = 4.8 \text{ mA}, V_{CC} = 4.5 \text{ V}$	HCPL0700	–	–	0.4		
<b>ISOLATION CHARACTERISTICS</b>								
$I_{I-O}$	Input–Output Insulation Leakage Current	Relative humidity = 45%, $T_A = 25^\circ\text{C}, t = 5 \text{ s},$ $V_{I-O} = 3000 \text{ VDC}$ (Note 4)		–	–	1.0	$\mu\text{A}$	
$V_{ISO}$	Withstand Insulation Test Voltage	$R_H \leq 50\%, T_A = 25^\circ\text{C},$ $I_{I-O} \leq 2 \mu\text{A}, t = 1 \text{ min.}$ (Notes 4, 5)		2500	–	–	$V_{RMS}$	
$R_{I-O}$	Resistance (Input to Output)	$V_{I-O} = 500 \text{ VDC}$ (Note 4)		–	$10^{12}$	–	$\Omega$	

# HCPL0700, HCPL0701, HCPL0731

## ELECTRICAL CHARACTERISTICS ( $T_A = 0$ to $70^\circ\text{C}$ unless otherwise noted) (continued)

Symbol	Parameter	Test Condition	Device	Min	Typ*	Max	Unit			
<b>SWITCHING CHARACTERISTICS (<math>V_{CC} = 5\text{ V}</math>)</b>										
$T_{PHL}$	Propagation Delay Time to Logic Low (Note 2) (Figure 14)	$R_L = 4.7\text{ k}\Omega$ , $I_F = 0.5\text{ mA}$	HCPL0701	-	-	30	$\mu\text{s}$			
			HCPL0731	-	-	120				
			$T_A = 25^\circ\text{C}$	HCPL0701	-	3		25		
				HCPL0731	-	5		100		
			$R_L = 270\ \Omega$ , $I_F = 12\text{ mA}$	HCPL0701	-	-		2		
				HCPL0731	-	-		3		
		$T_A = 25^\circ\text{C}$		HCPL0701	-	0.3		1		
				HCPL0731	-	0.4		2		
		$R_L = 2.2\text{ k}\Omega$ , $I_F = 1.6\text{ mA}$	HCPL0700	-	-	15				
			HCPL0731	-	-	25				
			$T_A = 25^\circ\text{C}$	HCPL0700	-	1		10		
				HCPL0731	-	2		20		
$T_{PLH}$	Propagation Delay Time to Logic High (Note 2) (Figure 14)	$R_L = 4.7\text{ k}\Omega$ , $I_F = 0.5\text{ mA}$	HCPL0701/31	-	-	90	$\mu\text{s}$			
			$T_A = 25^\circ\text{C}$	HCPL0701/31	-	12		60		
				$R_L = 270\ \Omega$ , $I_F = 12\text{ mA}$	HCPL0701	-		-	10	
			HCPL0731		-	-		15		
		$T_A = 25^\circ\text{C}$	HCPL0701	-	1.6	7				
			HCPL0731	-	1.6	10				
			$R_L = 2.2\text{ k}\Omega$ , $I_F = 1.6\text{ mA}$	HCPL0700/31	-	-		50		
				HCPL0700/31	-	7		35		
		$ICM_{HI}$	Common Mode Transient Immunity at Logic High	$I_F = 0\text{ mA}$ , $IV_{CM1} = 10\text{ V}_{P-P}$ , $T_A = 25^\circ\text{C}$ , $R_L = 2.2\text{ k}\Omega$ (Note 3) (Figure 15)	All	1,000		10,000	-	$\text{V}/\mu\text{s}$
		$ICM_{LI}$	Common Mode Transient Immunity at Logic Low	$I_F = 1.6\text{ mA}$ , $IV_{CM1} = 10\text{ V}_{P-P}$ , $T_A = 25^\circ\text{C}$ , $R_L = 2.2\text{ k}\Omega$ (Note 3) (Figure 15)	All	1,000		10,000	-	$\text{V}/\mu\text{s}$

Product parametric performance is indicated in the Electrical Characteristics for the listed test conditions, unless otherwise noted. Product performance may not be indicated by the Electrical Characteristics if operated under different conditions.

1. Current Transfer Ratio is defined as a ratio of output collector current,  $I_O$ , to the forward LED input current,  $I_F$  times 100%.
2. Pin 7 open. Use of a resistor between pins 5 and 7 will decrease gain and delay time.
3. Common mode transient immunity in logic high level is the maximum tolerable (positive)  $dV_{CM}/dt$  on the leading edge of the common mode pulse signal,  $V_{CM}$ , to assure that the output will remain in a logic high state (i.e.,  $V_O > 2.0\text{ V}$ ). Common mode transient immunity in logic low level is the maximum tolerable (negative)  $dV_{CM}/dt$  on the trailing edge of the common mode pulse signal,  $V_{CM}$ , to assure that the output will remain in a logic low state (i.e.,  $V_O < 0.8\text{ V}$ ).
4. Device is considered a two terminal device: Pins 1, 2, 3 and 4 are shorted together and Pins 5, 6, 7 and 8 are shorted together.
5. 2500 VAC RMS for 1 minute duration is equivalent to 3000 VAC RMS for 1 second duration.

\*All typicals at  $T_A = 25^\circ\text{C}$

# HCPL0700, HCPL0701, HCPL0731

## TYPICAL PERFORMANCE CURVES

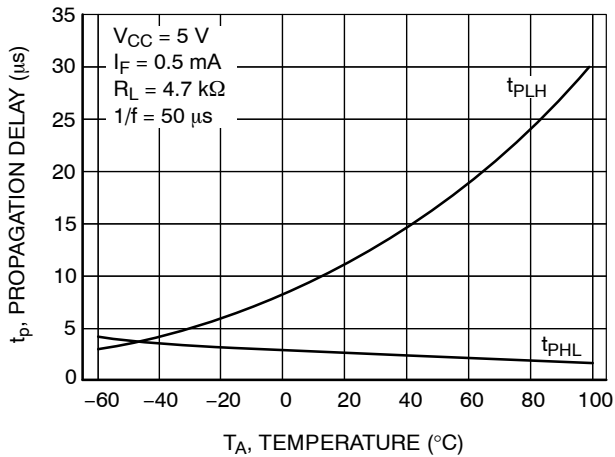

**Figure 1. Propagation Delay vs. Temperature (HCPL0700, HCPL0701)**

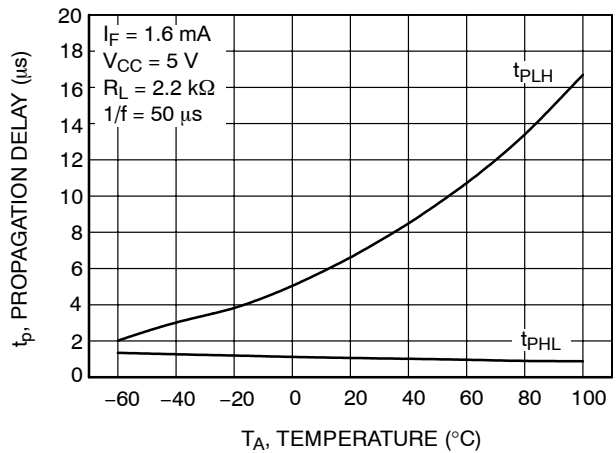

**Figure 2. Propagation Delay vs. Temperature (HCPL0700, HCPL0701)**

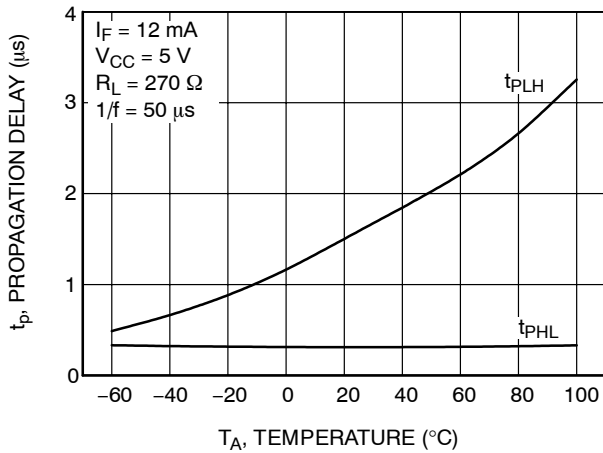

**Figure 3. Propagation Delay vs. Temperature (HCPL0700, HCPL0701)**

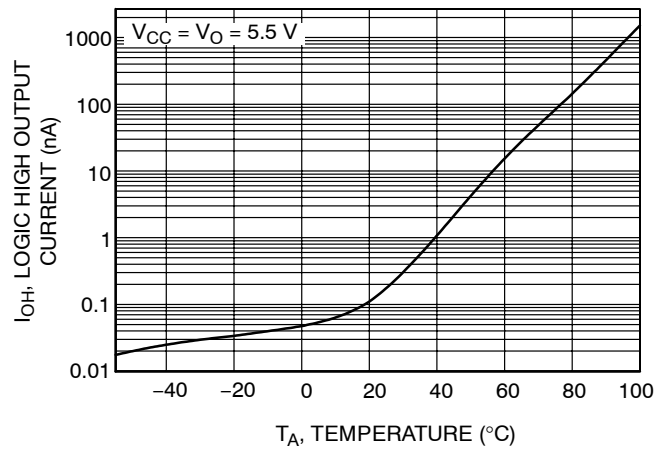

**Figure 4. Logic High Output Current vs. Temperature (HCPL0700, HCPL0701)**

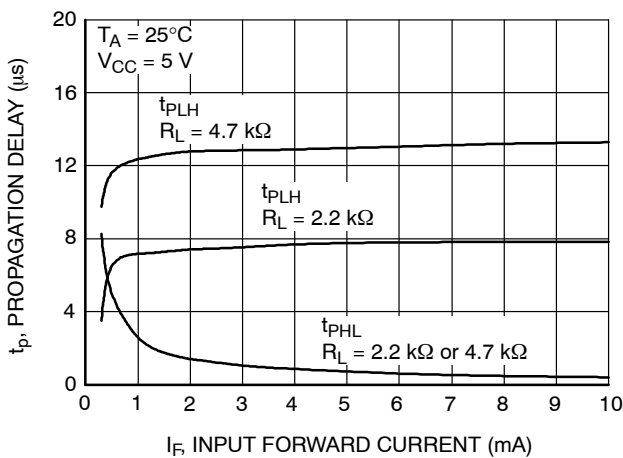

**Figure 5. Propagation Delay vs. Input Forward Current (HCPL0731)**

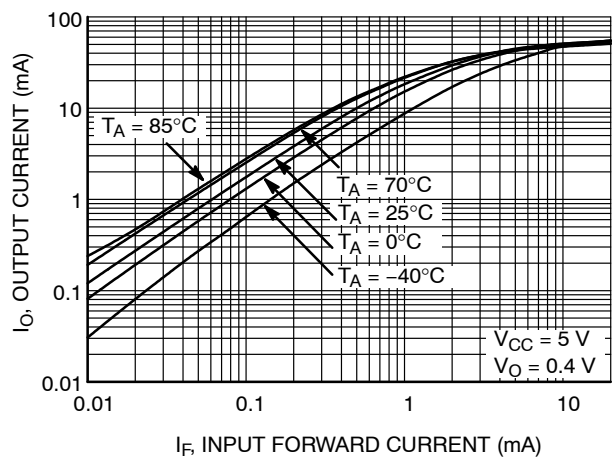

**Figure 6. Output Current vs. Input Forward Current (HCPL0700, HCPL0701)**

# HCPL0700, HCPL0701, HCPL0731

## TYPICAL PERFORMANCE CURVES (continued)

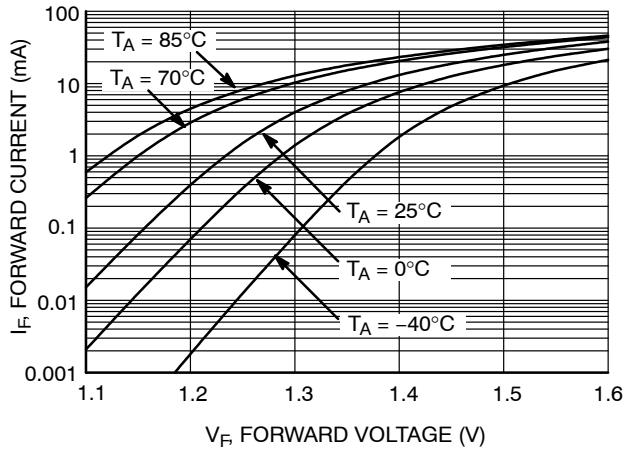

**Figure 7. Input Forward Current vs. Forward Voltage (HCPL0700, HCPL0701)**

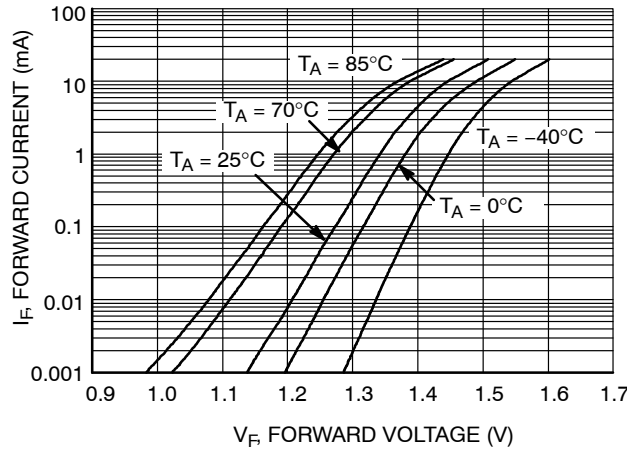

**Figure 8. Input Forward Current vs. Forward Voltage (HCPL0731)**

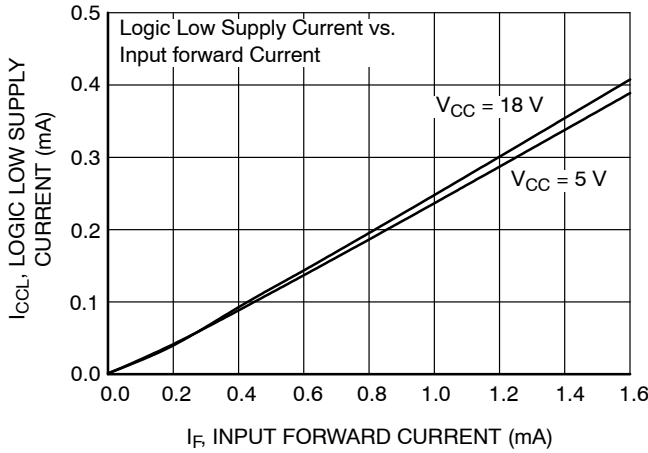

**Figure 9. Logic Low Supply Current vs. Input Forward Current (HCPL0700, HCPL0701)**

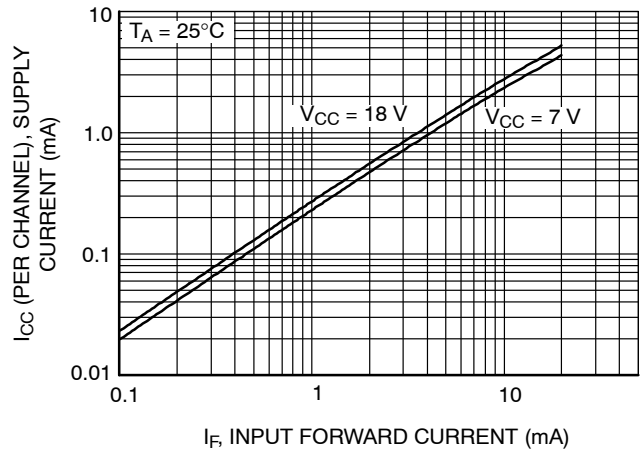

**Figure 10. Supply Current vs. Input Forward Current (HCPL0731)**

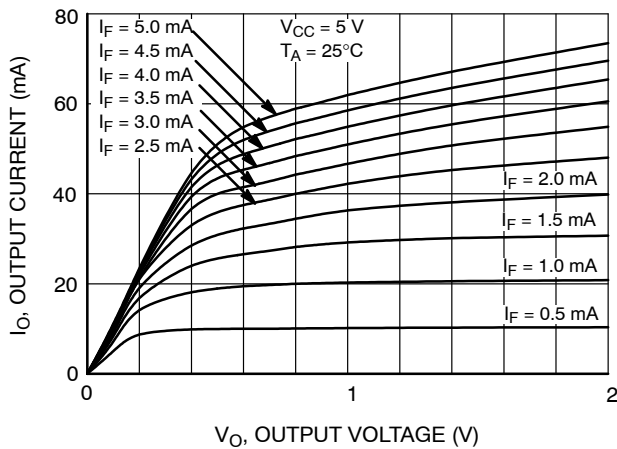

**Figure 11. DC Transfer Characteristics (HCPL0700, HCPL0701)**

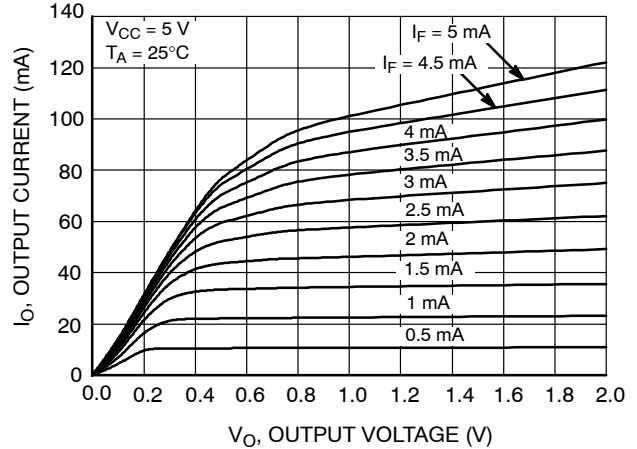

**Figure 12. DC Transfer Characteristics (HCPL0731)**

# HCPL0700, HCPL0701, HCPL0731

## TYPICAL PERFORMANCE CURVES (continued)

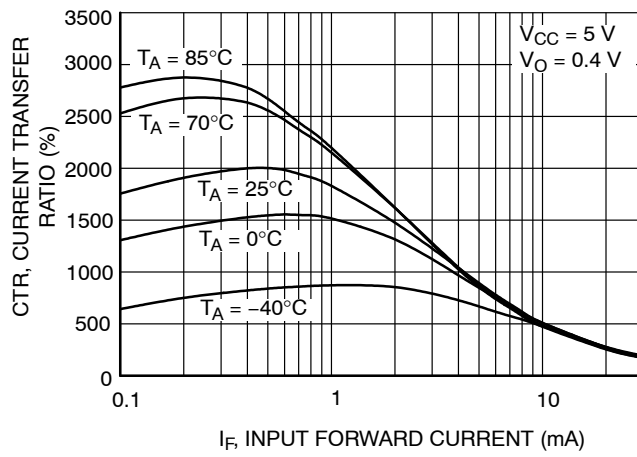

**Figure 13. Current Transfer Ratio vs. Input Forward Current (HCPL0700, HCPL0701)**





# HCPL0700, HCPL0701, HCPL0731

## REFLOW PROFILE

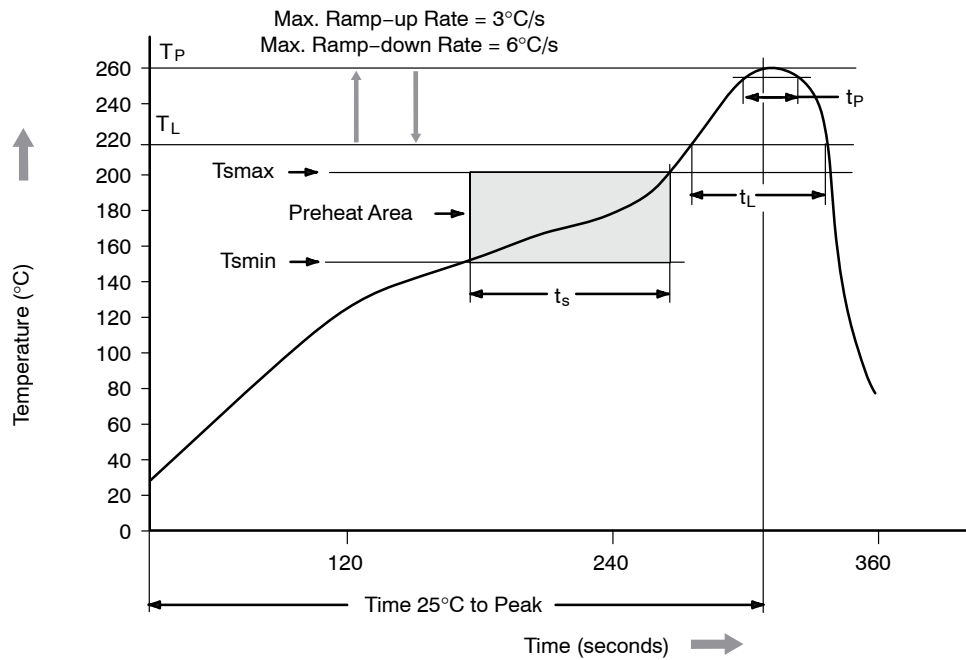

Figure 16. Reflow Profile

Table 1.

Profile Feature	Pb-Free Assembly Profile
Temperature Min. ( $T_{smin}$ )	150°C
Temperature Max. ( $T_{smax}$ )	200°C
Time ( $t_s$ ) from ( $T_{smin}$ to $T_{smax}$ )	60 – 120 seconds
Ramp-up Rate ( $t_L$ to $t_p$ )	3°C/second maximum
Liquidous Temperature ( $T_L$ )	217°C
Time ( $t_L$ ) Maintained Above ( $T_L$ )	60 – 150 seconds
Peak Body Package Temperature	260°C +0°C / -5°C
Time ( $t_p$ ) within 5°C of 260°C	30 seconds
Ramp-down Rate ( $T_P$ to $T_L$ )	6°C/second max.
Time 25°C to Peak Temperature	8 minutes max.

### ORDERING INFORMATION (Note 6)

Part Number	Package	Shipping <sup>†</sup>
HCPL0700	SOIC8	50 Units / Tube
HCPL0700R2	SOIC8	2500 / Tape & Reel
HCPL0700V	SOIC8 (VDE 0884)	50 Units / Tube

<sup>†</sup>For information on tape and reel specifications, including part orientation and tape sizes, please refer to our Tape and Reel Packaging Specifications Brochure, [BRD8011/D](#).

6. The product orderable part number system listed in this table also applies to the HCPL0701 and HCPL0731 products.

SOIC8  
CASE 751DZ  
ISSUE O

DATE 30 SEP 2016

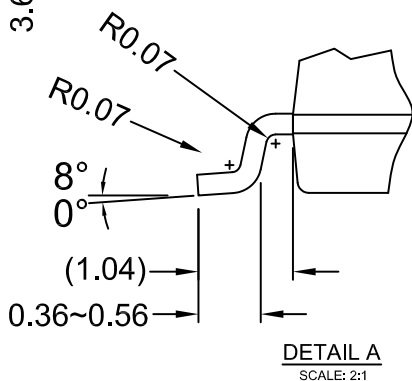
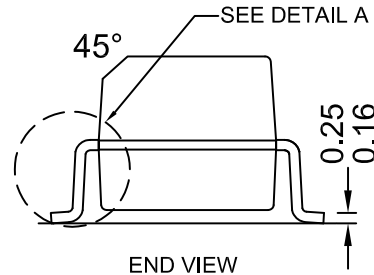
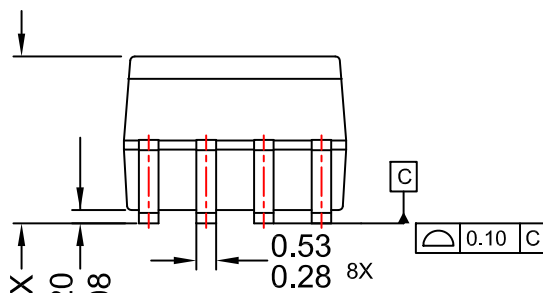
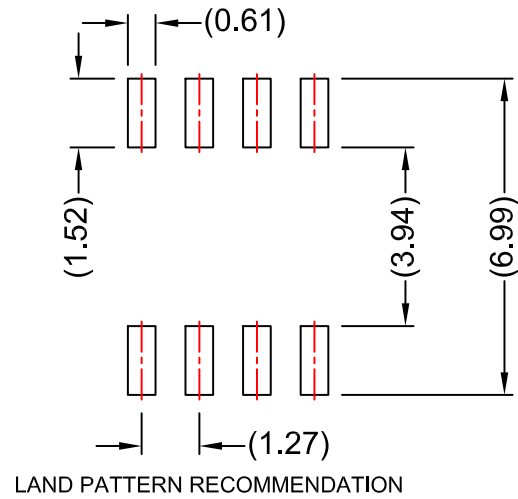
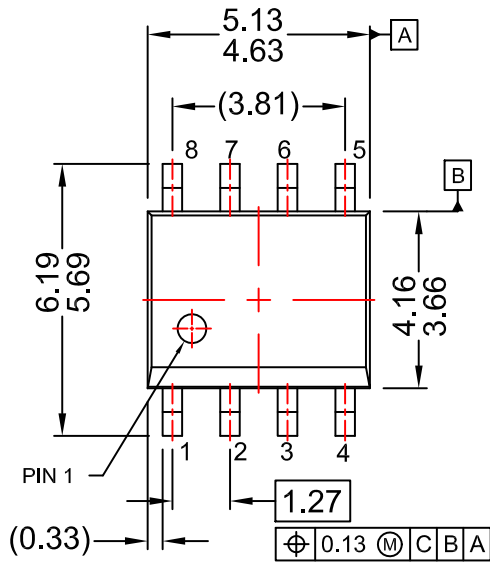

NOTES:

- A) NO STANDARD APPLIES TO THIS PACKAGE
- B) ALL DIMENSIONS ARE IN MILLIMETERS.
- C) DIMENSIONS DO NOT INCLUDE MOLD FLASH OR BURRS.
- D) LANDPATTERN STANDARD: SOIC127P600X175-8M.

DOCUMENT NUMBER:	98AON13733G	Electronic versions are uncontrolled except when accessed directly from the Document Repository. Printed versions are uncontrolled except when stamped "CONTROLLED COPY" in red.
DESCRIPTION:	SOIC8	PAGE 1 OF 1

onsemi and ONSEMI are trademarks of Semiconductor Components Industries, LLC dba onsemi or its subsidiaries in the United States and/or other countries. onsemi reserves the right to make changes without further notice to any products herein. onsemi makes no warranty, representation or guarantee regarding the suitability of its products for any particular purpose, nor does onsemi assume any liability arising out of the application or use of any product or circuit, and specifically disclaims any and all liability, including without limitation special, consequential or incidental damages. onsemi does not convey any license under its patent rights nor the rights of others.

**onsemi**, **Onsemi**, and other names, marks, and brands are registered and/or common law trademarks of Semiconductor Components Industries, LLC dba "**onsemi**" or its affiliates and/or subsidiaries in the United States and/or other countries. **onsemi** owns the rights to a number of patents, trademarks, copyrights, trade secrets, and other intellectual property. A listing of **onsemi**'s product/patent coverage may be accessed at [www.onsemi.com/site/pdf/Patent-Marking.pdf](http://www.onsemi.com/site/pdf/Patent-Marking.pdf). **onsemi** reserves the right to make changes at any time to any products or information herein, without notice. The information herein is provided "as-is" and **onsemi** makes no warranty, representation or guarantee regarding the accuracy of the information, product features, availability, functionality, or suitability of its products for any particular purpose, nor does **onsemi** assume any liability arising out of the application or use of any product or circuit, and specifically disclaims any and all liability, including without limitation special, consequential or incidental damages. Buyer is responsible for its products and applications using **onsemi** products, including compliance with all laws, regulations and safety requirements or standards, regardless of any support or applications information provided by **onsemi**. "Typical" parameters which may be provided in **onsemi** data sheets and/or specifications can and do vary in different applications and actual performance may vary over time. All operating parameters, including "Typicals" must be validated for each customer application by customer's technical experts. **onsemi** does not convey any license under any of its intellectual property rights nor the rights of others. **onsemi** products are not designed, intended, or authorized for use as a critical component in life support systems or any FDA Class 3 medical devices or medical devices with a same or similar classification in a foreign jurisdiction or any devices intended for implantation in the human body. Should Buyer purchase or use **onsemi** products for any such unintended or unauthorized application, Buyer shall indemnify and hold **onsemi** and its officers, employees, subsidiaries, affiliates, and distributors harmless against all claims, costs, damages, and expenses, and reasonable attorney fees arising out of, directly or indirectly, any claim of personal injury or death associated with such unintended or unauthorized use, even if such claim alleges that **onsemi** was negligent regarding the design or manufacture of the part. **onsemi** is an Equal Opportunity/Affirmative Action Employer. This literature is subject to all applicable copyright laws and is not for resale in any manner.

## ADDITIONAL INFORMATION

### TECHNICAL PUBLICATIONS:

Technical Library: [www.onsemi.com/design/resources/technical-documentation](http://www.onsemi.com/design/resources/technical-documentation)  
onsemi Website: [www.onsemi.com](http://www.onsemi.com)

### ONLINE SUPPORT: [www.onsemi.com/support](http://www.onsemi.com/support)

For additional information, please contact your local Sales Representative at [www.onsemi.com/support/sales](http://www.onsemi.com/support/sales)