

Complementary Dual General Purpose Amplifier Transistor

HN1B01FDW1T1G, SHN1B01FDW1T1G

PNP and NPN Surface Mount



SC-74
CASE 318F
STYLE 3

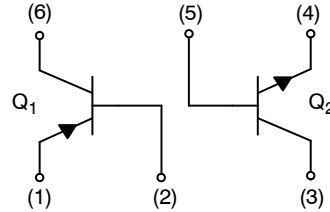

Features

- High Voltage and High Current: $V_{CEO} = 50\text{ V}$, $I_C = 200\text{ mA}$
- High h_{FE} : $h_{FE} = 200 \sim 400$
- Moisture Sensitivity Level: 1
- ESD Rating
 - ◆ Human Body Model: 3A
 - ◆ Machine Model: C
- S Prefix for Automotive and Other Applications Requiring Unique Site and Control Change Requirements; AEC-Q101 Qualified and PPAP Capable
- These Devices are Pb-Free, Halogen Free/BFR Free and are RoHS Compliant*

MAXIMUM RATINGS ($T_A = 25^\circ\text{C}$)

Rating	Symbol	Value	Unit
Collector-Base Voltage	$V_{(BR)CBO}$	60	Vdc
Collector-Emitter Voltage	$V_{(BR)CEO}$	50	Vdc
Emitter-Base Voltage	$V_{(BR)EBO}$	7.0	Vdc
Collector Current - Continuous	I_C	200	mAdc

Stresses exceeding those listed in the Maximum Ratings table may damage the device. If any of these limits are exceeded, device functionality should not be assumed, damage may occur and reliability may be affected.

THERMAL CHARACTERISTICS

Characteristic	Symbol	Max	Unit
Power Dissipation	P_D	380	mW
Junction Temperature	T_J	150	$^\circ\text{C}$
Storage Temperature	T_{stg}	-55 to +150	$^\circ\text{C}$

*For additional information on our Pb-Free strategy and soldering details, please download the onsemi Soldering and Mounting Techniques Reference Manual, SOLDERRM/D.

MARKING DIAGRAM

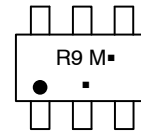

- R9 = Specific Device Code
- M = Date Code
- = Pb-Free Package

ORDERING INFORMATION

Device	Package	Shipping†
HN1B01FDW1T1G	SC-74 (Pb-Free)	3,000/Tape & Reel
SHN1B01FDW1T1G	SC-74 (Pb-Free)	3,000/Tape & Reel

†For information on tape and reel specifications, including part orientation and tape sizes, please refer to our Tape and Reel Packaging Specifications Brochure, BRD8011/D.

HN1B01FDW1T1G, SHN1B01FDW1T1G

Q1: PNP

ELECTRICAL CHARACTERISTICS ($T_A = 25^\circ\text{C}$ unless otherwise noted)

Characteristic	Symbol	Min	Max	Unit
Collector–Emitter Breakdown Voltage ($I_C = 2.0\text{ mAdc}$, $I_B = 0$)	$V_{(BR)CEO}$	-50	-	Vdc
Collector–Base Breakdown Voltage ($I_C = 10\ \mu\text{Adc}$, $I_E = 0$)	$V_{(BR)CBO}$	-60	-	Vdc
Emitter–Base Breakdown Voltage ($I_E = 10\ \mu\text{Adc}$, $I_C = 0$)	$V_{(BR)EBO}$	-7.0	-	Vdc
Collector–Base Cutoff Current ($V_{CB} = 45\text{ Vdc}$, $I_E = 0$)	I_{CBO}	-	-0.1	μAdc
Collector–Emitter Cutoff Current ($V_{CE} = 10\text{ Vdc}$, $I_B = 0$) ($V_{CE} = 30\text{ Vdc}$, $I_B = 0$) ($V_{CE} = 30\text{ Vdc}$, $I_B = 0$, $T_A = 80^\circ\text{C}$)	I_{CEO}	-	-0.1 -2.0 -1.0	μAdc μAdc mAdc
DC Current Gain (Note 1) ($V_{CE} = 6.0\text{ Vdc}$, $I_C = 2.0\text{ mAdc}$)	h_{FE}	-200	-400	-
Collector–Emitter Saturation Voltage ($I_C = 100\text{ mAdc}$, $I_B = 10\text{ mAdc}$)	$V_{CE(sat)}$	-	-0.3	Vdc

Q2: NPN

ELECTRICAL CHARACTERISTICS ($T_A = 25^\circ\text{C}$ unless otherwise noted)

Characteristic	Symbol	Min	Max	Unit
Collector–Emitter Breakdown Voltage ($I_C = 2.0\text{ mAdc}$, $I_B = 0$)	$V_{(BR)CEO}$	50	-	Vdc
Collector–Base Breakdown Voltage ($I_C = 10\ \mu\text{Adc}$, $I_E = 0$)	$V_{(BR)CBO}$	60	-	Vdc
Emitter–Base Breakdown Voltage ($I_E = 10\ \mu\text{Adc}$, $I_C = 0$)	$V_{(BR)EBO}$	7.0	-	Vdc
Collector–Base Cutoff Current ($V_{CB} = 45\text{ Vdc}$, $I_E = 0$)	I_{CBO}	-	0.1	μAdc
Collector–Emitter Cutoff Current ($V_{CE} = 10\text{ Vdc}$, $I_B = 0$) ($V_{CE} = 30\text{ Vdc}$, $I_B = 0$) ($V_{CE} = 30\text{ Vdc}$, $I_B = 0$, $T_A = 80^\circ\text{C}$)	I_{CEO}	-	0.1 2.0 1.0	μAdc μAdc mAdc
DC Current Gain (Note 1) ($V_{CE} = 6.0\text{ Vdc}$, $I_C = 2.0\text{ mAdc}$)	h_{FE}	200	400	-
Collector–Emitter Saturation Voltage ($I_C = 100\text{ mAdc}$, $I_B = 10\text{ mAdc}$)	$V_{CE(sat)}$	-	0.25	Vdc

1. Pulse Test: Pulse Width $\leq 300\ \mu\text{s}$, D.C. $\leq 2\%$.

TYPICAL ELECTRICAL CHARACTERISTICS: PNP TRANSISTOR

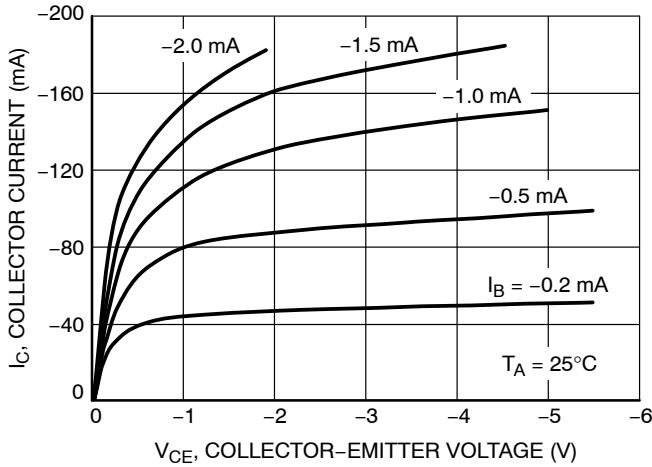

Figure 1. Collector Saturation Region

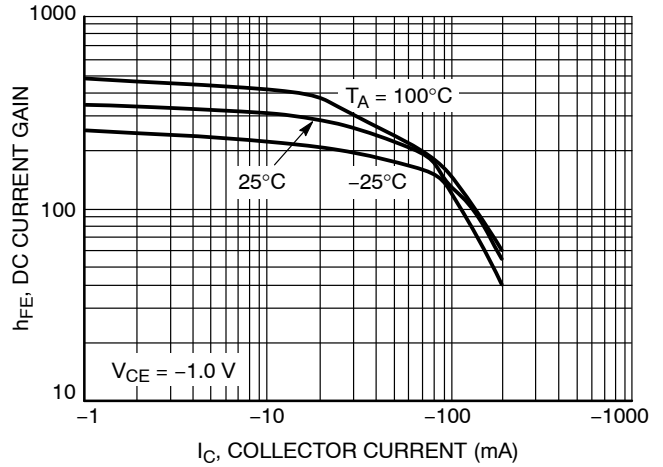

Figure 2. DC Current Gain

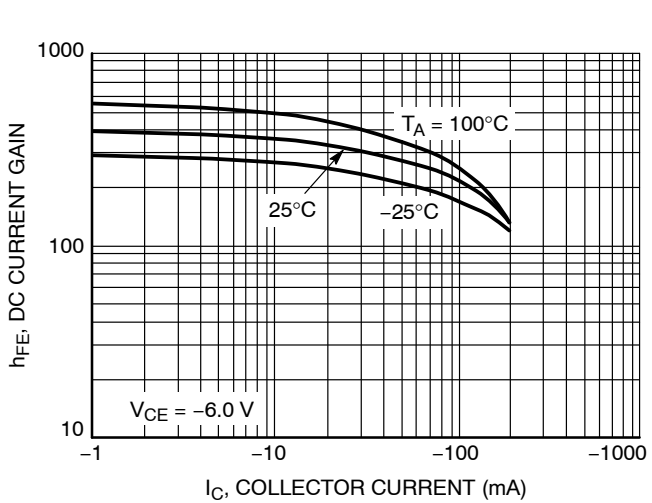

Figure 3. DC Current Gain

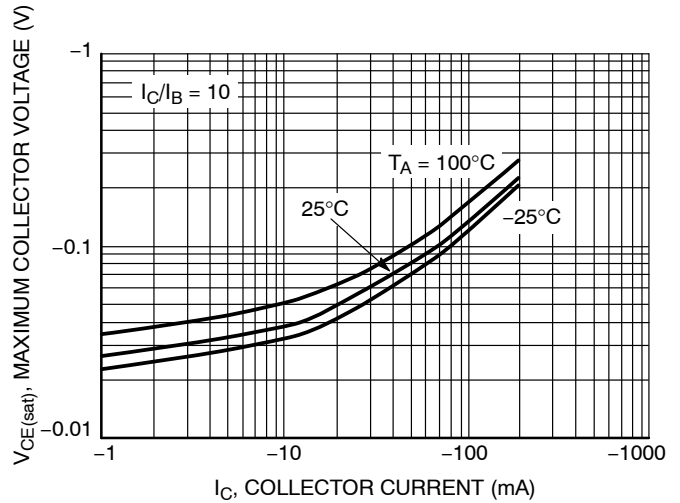

Figure 4. $V_{CE(sat)}$ versus I_C

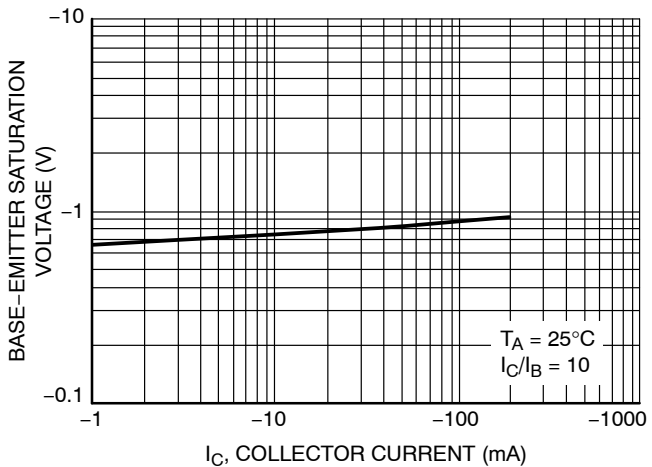

Figure 5. $V_{BE(sat)}$ versus I_C

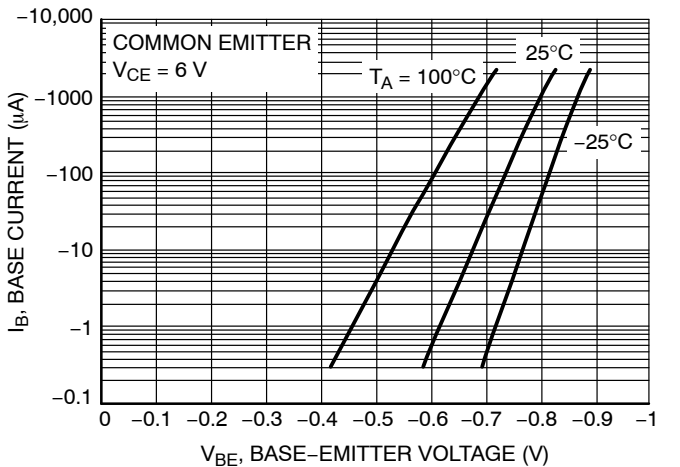

Figure 6. Base-Emitter Voltage

TYPICAL ELECTRICAL CHARACTERISTICS: NPN TRANSISTOR

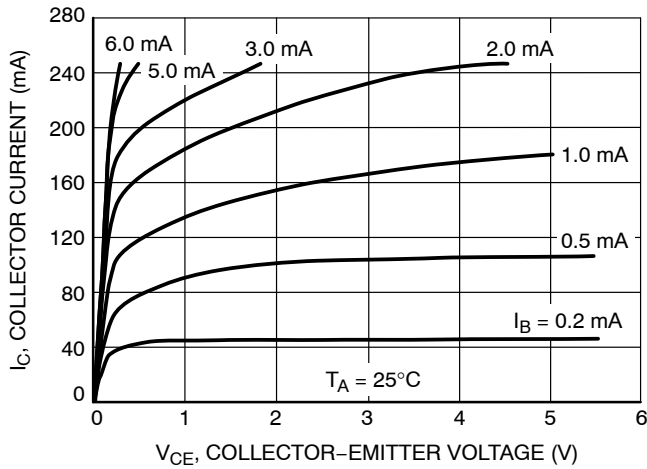

Figure 7. Collector Saturation Voltage

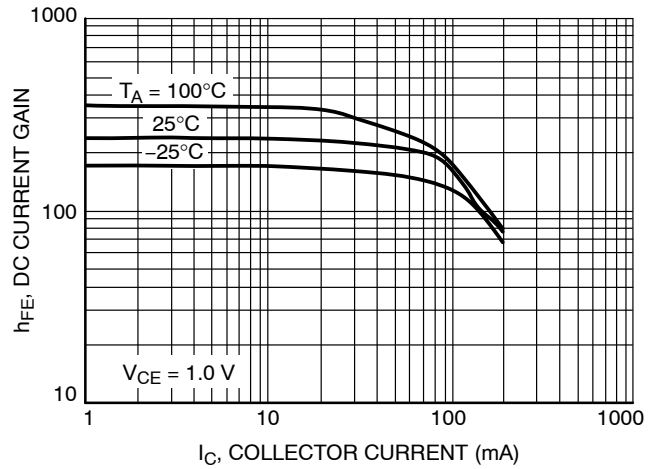

Figure 8. DC Current Gain

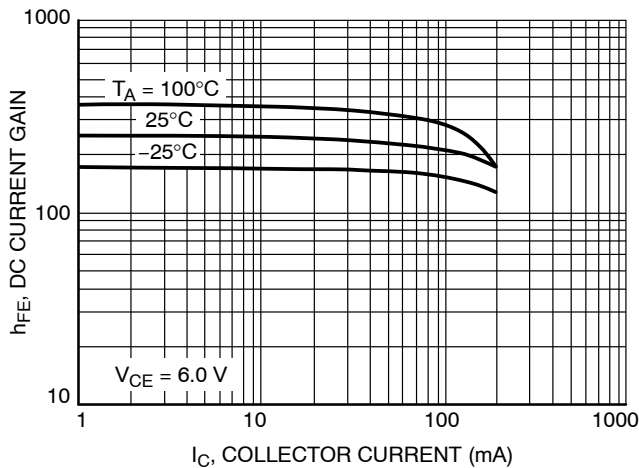

Figure 9. DC Current Gain

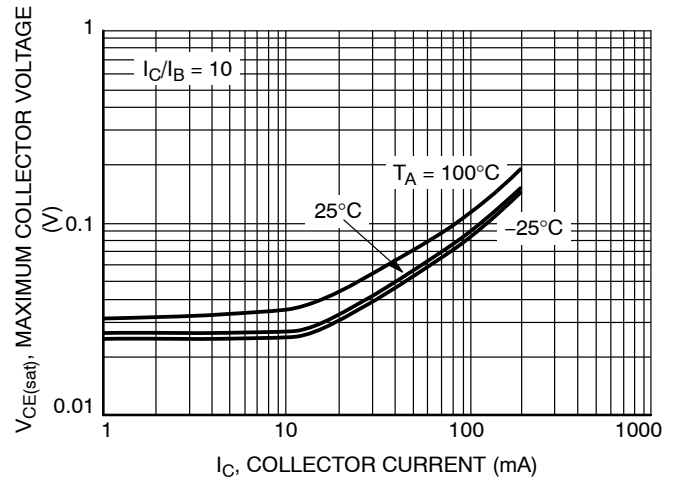

Figure 10. $V_{CE(sat)}$ versus I_C

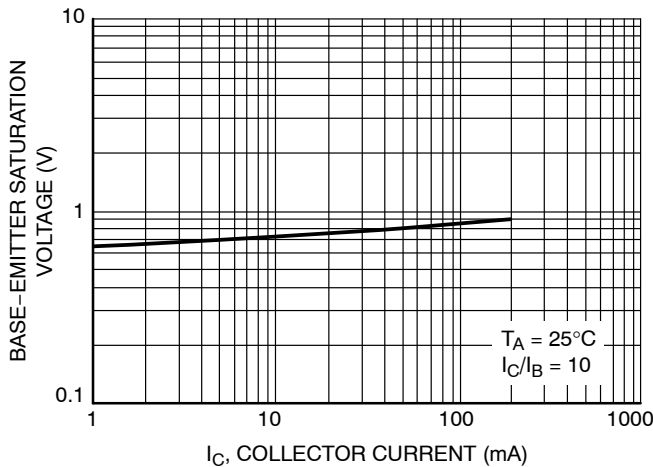

Figure 11. $V_{BE(sat)}$ versus I_C

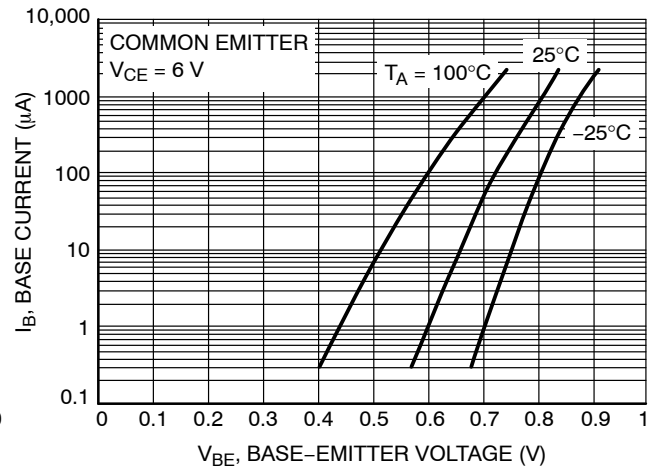

Figure 12. Base-Emitter Voltage

HN1B01FDW1T1G, SHN1B01FDW1T1G

TYPICAL ELECTRICAL CHARACTERISTICS

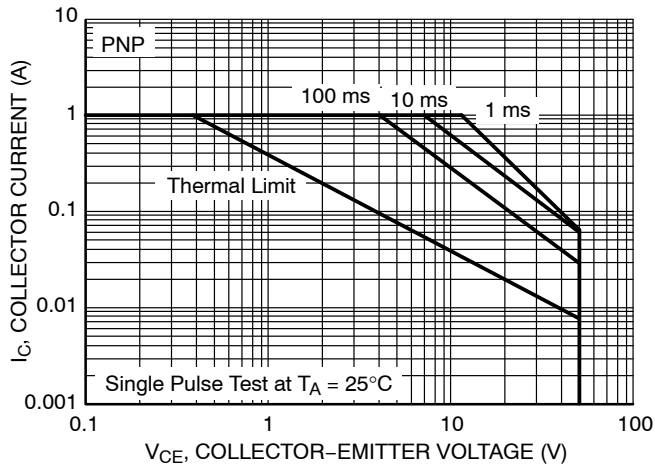

Figure 13. PNP Safe Operating Area

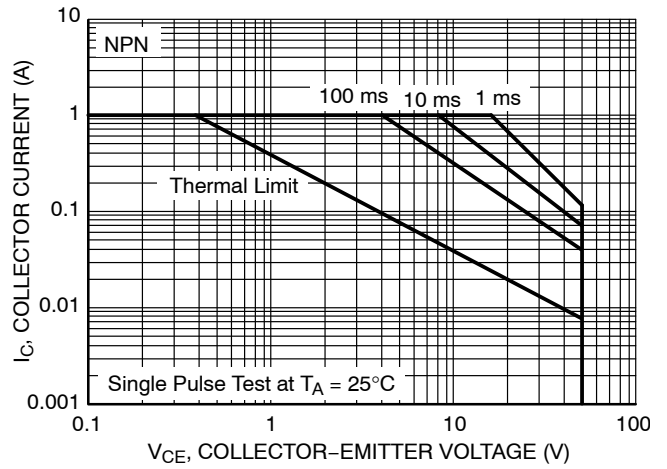

Figure 14. NPN Safe Operating Area



SCALE 2:1

SC-74
CASE 318F
ISSUE P

DATE 07 OCT 2021

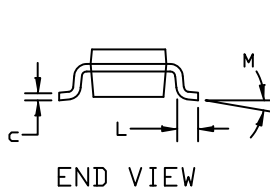
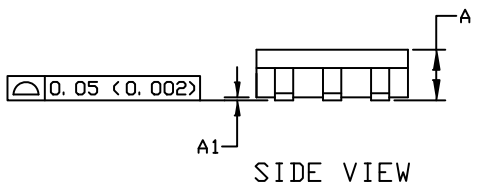
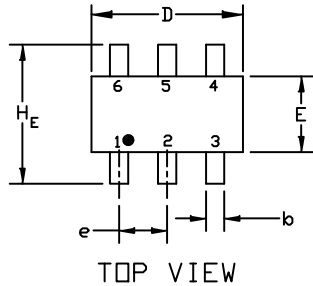

GENERIC
MARKING DIAGRAM*

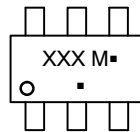

XXX = Specific Device Code
M = Date Code
▪ = Pb-Free Package

(Note: Microdot may be in either location)

*This information is generic. Please refer to device data sheet for actual part marking. Pb-Free indicator, "G" or microdot "▪", may or may not be present. Some products may not follow the Generic Marking.

NOTES:

1. DIMENSIONING AND TOLERANCING PER ASME Y14.5M, 1994
2. CONTROLLING DIMENSION: INCHES
3. MAXIMUM LEAD THICKNESS INCLUDES LEAD FINISH THICKNESS. MINIMUM LEAD THICKNESS IS THE MINIMUM THICKNESS OF THE BASE MATERIAL.

DIM	MILLIMETERS			INCHES		
	MIN.	NOM.	MAX.	MIN.	NOM.	MAX.
A	0.90	1.00	1.10	0.035	0.039	0.043
A1	0.01	0.06	0.10	0.001	0.002	0.004
b	0.25	0.37	0.50	0.010	0.015	0.020
c	0.10	0.18	0.26	0.004	0.007	0.010
D	2.90	3.00	3.10	0.114	0.118	0.122
E	1.30	1.50	1.70	0.051	0.059	0.067
e	0.85	0.95	1.05	0.034	0.037	0.041
HE	2.50	2.75	3.00	0.099	0.108	0.118
L	0.20	0.40	0.60	0.008	0.016	0.024
M	0*	---	10*	0*	---	10*

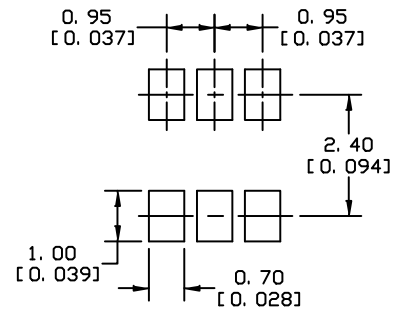

* For additional information on our Pb-Free strategy and soldering details, please download the DN Semiconductor Soldering and Mounting Techniques Reference Manual, SOLDERM/D.

SOLDERING FOOTPRINT

<p>STYLE 1: PIN 1. CATHODE 2. ANODE 3. CATHODE 4. CATHODE 5. ANODE 6. CATHODE</p>	<p>STYLE 2: PIN 1. NO CONNECTION 2. COLLECTOR 3. EMITTER 4. NO CONNECTION 5. COLLECTOR 6. BASE</p>	<p>STYLE 3: PIN 1. EMITTER 1 2. BASE 1 3. COLLECTOR 2 4. EMITTER 2 5. BASE 2 6. COLLECTOR 1</p>	<p>STYLE 4: PIN 1. COLLECTOR 2 2. EMITTER 1/EMITTER 2 3. COLLECTOR 1 4. EMITTER 3 5. BASE 1/BASE 2/COLLECTOR 3 6. BASE 3</p>	<p>STYLE 5: PIN 1. CHANNEL 1 2. ANODE 3. CHANNEL 2 4. CHANNEL 3 5. CATHODE 6. CHANNEL 4</p>	<p>STYLE 6: PIN 1. CATHODE 2. ANODE 3. CATHODE 4. CATHODE 5. CATHODE 6. CATHODE</p>
<p>STYLE 7: PIN 1. SOURCE 1 2. GATE 1 3. DRAIN 2 4. SOURCE 2 5. GATE 2 6. DRAIN 1</p>	<p>STYLE 8: PIN 1. EMITTER 1 2. BASE 2 3. COLLECTOR 2 4. EMITTER 2 5. BASE 1 6. COLLECTOR 1</p>	<p>STYLE 9: PIN 1. EMITTER 2 2. BASE 2 3. COLLECTOR 1 4. EMITTER 1 5. BASE 1 6. COLLECTOR 2</p>	<p>STYLE 10: PIN 1. ANODE/CATHODE 2. BASE 3. EMITTER 4. COLLECTOR 5. ANODE 6. CATHODE</p>	<p>STYLE 11: PIN 1. EMITTER 2. BASE 3. ANODE/CATHODE 4. ANODE 5. CATHODE 6. COLLECTOR</p>	

DOCUMENT NUMBER:	98ASB42973B	Electronic versions are uncontrolled except when accessed directly from the Document Repository. Printed versions are uncontrolled except when stamped "CONTROLLED COPY" in red.
DESCRIPTION:	SC-74	PAGE 1 OF 1

onsemi and onsemi are trademarks of Semiconductor Components Industries, LLC dba onsemi or its subsidiaries in the United States and/or other countries. onsemi reserves the right to make changes without further notice to any products herein. onsemi makes no warranty, representation or guarantee regarding the suitability of its products for any particular purpose, nor does onsemi assume any liability arising out of the application or use of any product or circuit, and specifically disclaims any and all liability, including without limitation special, consequential or incidental damages. onsemi does not convey any license under its patent rights nor the rights of others.

onsemi, **Onsemi**, and other names, marks, and brands are registered and/or common law trademarks of Semiconductor Components Industries, LLC dba "**onsemi**" or its affiliates and/or subsidiaries in the United States and/or other countries. **onsemi** owns the rights to a number of patents, trademarks, copyrights, trade secrets, and other intellectual property. A listing of **onsemi**'s product/patent coverage may be accessed at www.onsemi.com/site/pdf/Patent-Marking.pdf. **onsemi** reserves the right to make changes at any time to any products or information herein, without notice. The information herein is provided "as-is" and **onsemi** makes no warranty, representation or guarantee regarding the accuracy of the information, product features, availability, functionality, or suitability of its products for any particular purpose, nor does **onsemi** assume any liability arising out of the application or use of any product or circuit, and specifically disclaims any and all liability, including without limitation special, consequential or incidental damages. Buyer is responsible for its products and applications using **onsemi** products, including compliance with all laws, regulations and safety requirements or standards, regardless of any support or applications information provided by **onsemi**. "Typical" parameters which may be provided in **onsemi** data sheets and/or specifications can and do vary in different applications and actual performance may vary over time. All operating parameters, including "Typicals" must be validated for each customer application by customer's technical experts. **onsemi** does not convey any license under any of its intellectual property rights nor the rights of others. **onsemi** products are not designed, intended, or authorized for use as a critical component in life support systems or any FDA Class 3 medical devices or medical devices with a same or similar classification in a foreign jurisdiction or any devices intended for implantation in the human body. Should Buyer purchase or use **onsemi** products for any such unintended or unauthorized application, Buyer shall indemnify and hold **onsemi** and its officers, employees, subsidiaries, affiliates, and distributors harmless against all claims, costs, damages, and expenses, and reasonable attorney fees arising out of, directly or indirectly, any claim of personal injury or death associated with such unintended or unauthorized use, even if such claim alleges that **onsemi** was negligent regarding the design or manufacture of the part. **onsemi** is an Equal Opportunity/Affirmative Action Employer. This literature is subject to all applicable copyright laws and is not for resale in any manner.

ADDITIONAL INFORMATION

TECHNICAL PUBLICATIONS:

Technical Library: www.onsemi.com/design/resources/technical-documentation
onsemi Website: www.onsemi.com

ONLINE SUPPORT: www.onsemi.com/support

For additional information, please contact your local Sales Representative at www.onsemi.com/support/sales