

SPS

KA5L0380R

The SPS product family is specially designed for an off-line SMPS with minimal external components. The SPS consist of high voltage power SENSEFET[®] and current mode PWM IC.

Included PWM controller features integrated fixed frequency oscillator, under voltage lock-out, leading edge blanking, optimized gate turn-on/turn-off driver, thermal shutdown protection, over voltage protection, and temperature compensated precision current sources for loop compensation and fault protection circuitry. Compared to discrete MOSFET and PWM controller or RCC solution, a SPS can reduce total component count, design size, weight and at the same time increase efficiency, productivity, and system reliability.

It has a basic platform well suited for cost-effective design in either a flyback converter or a forward converter.

Features

- Precision Fixed Operating Frequency (50 kHz)
- Low Start-Up Current (Typ. 100 mA)
- Pulse By Pulse Current Limiting
- Over Current Protection
- Over Voltage Protection (Min. 25 V)
- Internal Thermal Shutdown Function
- Under Voltage Lockout
- Internal High Voltage Sense FET
- Auto-Restart Mode
- This is a Pb-Free Device

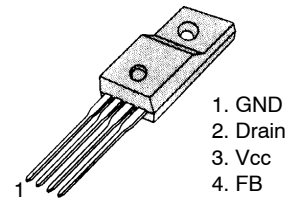

TO-220F-4L
CASE 340BK

MARKING DIAGRAM

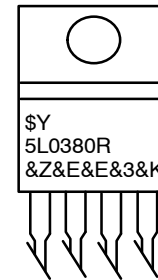

- \$Y = onsemi Logo
- 5L0380R = Specific Device Code
- &Z = Assembly Plant Code
- &E = Designates Space
- &3 = 3-Digit Date Code
- &K = Lot Code

ORDERING INFORMATION

See detailed ordering and shipping information on page 10 of this data sheet.

KA5L0380R

ELECTRICAL CHARACTERISTICS (SFET PART) ($T_a = 25^\circ\text{C}$ unless otherwise noted)

Characteristic	Symbol	Test Condition	Min	Typ	Max	Unit
Drain-Source Breakdown Voltage	BV_{DSS}	$V_{GS} = 0\text{ V}, I_D = 50\ \mu\text{A}$	800	-	-	V
Zero Gate Voltage Drain Current	I_{DSS}	$V_{DS} = \text{Max.}, \text{Rating}, V_{GS} = 0\text{ V}$	-	-	250	μA
		$V_{DS} = 0.8\ \text{Max.}, \text{Rating}, V_{GS} = 0\text{ V}, T_C = 125^\circ\text{C}$	-	-	1000	μA
Static Drain-Source On Resistance (Note 5)	$R_{DS(ON)}$	$V_{GS} = 10\text{ V}, I_D = 0.5\text{ A}$	-	4	5	Ω
Forward Transconductance (Note 5)	gfs	$V_{DS} = 50\text{ V}, I_D = 0.5\text{ A}$	1.5	2.5	-	S
Input Capacitance	C_{iss}	$V_{GS} = 0\text{ V}, V_{DS} = 25\text{ V}, f = 1\text{ MHz}$	-	779	-	pF
Output Capacitance	C_{oss}		-	75.6	-	
Reverse Transfer Capacitance	C_{rss}		-	24.9	-	
Turn Off Delay Time	td(on)	$V_{DD} = 0.5 BV_{DSS}, I_D = 1.0\text{ A}$ (MOSFET switching time are essentially independent of operating temperature)	-	40	-	ns
Rise Time	tr		-	95	-	
Turn Off Delay Time	td(off)		-	150	-	
Fall Time	tf		-	60	-	
Total Gate Charge (Gate-source + Gate-drain)	Qg	$V_{GS} = 10\text{ V}, I_D = 1.0\text{ A}, V_{DS} = 0.5 BV_{DSS}$ (MOSFET switching time are essentially independent of operating temperature)	-	-	34	nC
Gate-Source Charge	Qgs		-	7.2	-	
Gate-Drain (Miller) Charge	Qgd		-	12.1	-	

Product parametric performance is indicated in the Electrical Characteristics for the listed test conditions, unless otherwise noted. Product performance may not be indicated by the Electrical Characteristics if operated under different conditions.

5. Pulse test: Pulse width $\leq 300\ \mu\text{s}$, duty cycle $\leq 2\%$.

KA5L0380R

ELECTRICAL CHARACTERISTICS (CONTROL PART) ($T_a = 25^\circ\text{C}$ unless otherwise noted)

Parameter	Symbol	Test Condition	Min	Typ	Max	Unit
-----------	--------	----------------	-----	-----	-----	------

REFERENCE SECTION

Output Voltage (Note 6)	V_{ref}	$T_a = 25^\circ\text{C}$	4.80	5.00	5.20	V
Temperature Stability (Note 6, Note 7)	$V_{ref}/\Delta T$	$-25^\circ\text{C} \leq T_a \leq +85^\circ\text{C}$	-	0.3	0.6	mV/°C

OSCILLATOR SECTION

Initial Accuracy	F_{OSC}	$T_a = 25^\circ\text{C}$	45	50	55	kHz
Frequency Change with Temperature (Note 7)	$\Delta F/\Delta T$	$-25^\circ\text{C} \leq T_a \leq +85^\circ\text{C}$	-	± 5	± 10	%

PWM SECTION

Maximum Duty Cycle	D_{max}	-	74	77	80	%
--------------------	-----------	---	----	----	----	---

FEEDBACK SECTION

Feedback Source Current	I_{FB}	$T_a = 25^\circ\text{C}, 0\text{ V} \leq V_{fb} \leq 3\text{ V}$	0.7	0.9	1.1	mA
Shutdown Delay Current	I_{delay}	$T_a = 25^\circ\text{C}, 5\text{ V} \leq V_{fb} \leq V_{SD}$	4	5	6	μA

OVER CURRENT PROTECTION SECTION

Over Current Protection	$I_{L(max)}$	Max. Inductor current	1.89	2.15	2.41	A
-------------------------	--------------	-----------------------	------	------	------	---

UVLO SECTION

Start Threshold Voltage	$V_{th(H)}$	-	8.4	9	9.6	V
Minimum Operating Voltage	$V_{th(L)}$	After turn on	14	15	16	V

TOTAL STANDBY CURRENT SECTION

Start Current	I_{ST}	$V_{CC} = 14\text{ V}$	-	0.1	0.17	mA
Operating Supply Current (Control Part Only)	I_{OPR}	$V_{CC} \leq 28$	-	7	12	mA

SHUTDOWN SECTION

Shutdown Feedback Voltage	V_{SD}	$V_{fb} \geq 6.5\text{ V}$	6.9	7.5	8.1	V
Thermal Shutdown Temperature (T_j) (Note 6)	T_{SD}	-	140	160	-	°C
Over Voltage Protection	V_{OVP}	$V_{CC} \geq 24\text{ V}$	25	27	29	V

Product parametric performance is indicated in the Electrical Characteristics for the listed test conditions, unless otherwise noted. Product performance may not be indicated by the Electrical Characteristics if operated under different conditions.

6. These parameters, although guaranteed, are not 100% tested in production.

7. These parameters, although guaranteed, are tested in EDS (wafer test) process.

TYPICAL PERFORMANCE CHARACTERISTICS (SFET part)

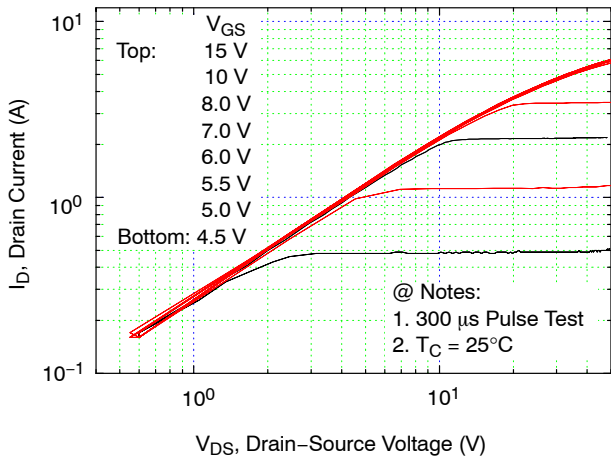

Figure 2. Output Characteristics

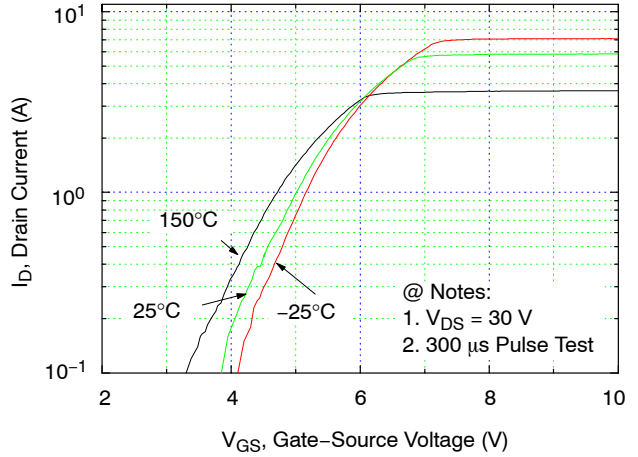

Figure 3. Transfer Characteristics

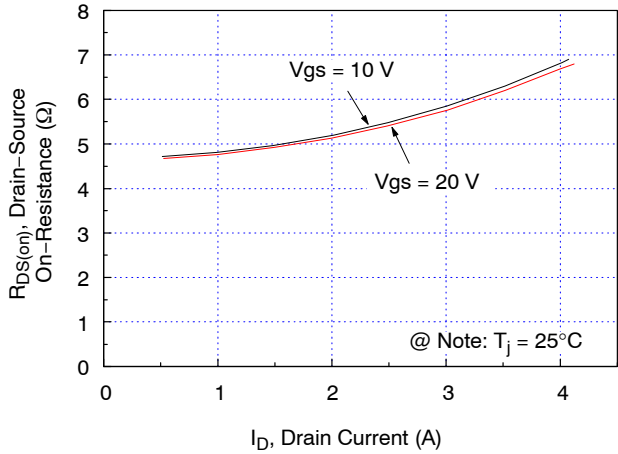

Figure 4. On-Resistance vs. Drain Current

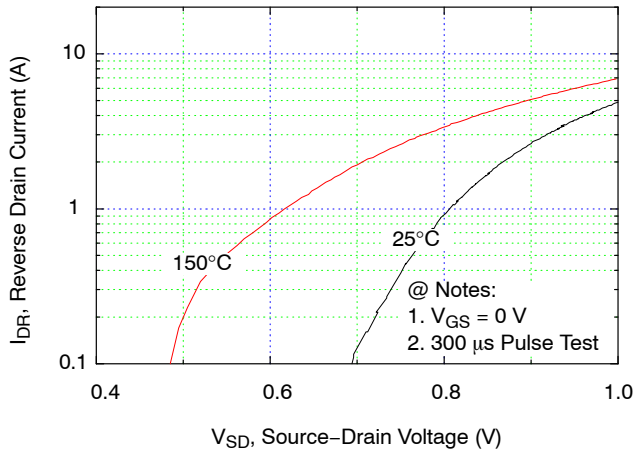

Figure 5. Source-Drain Diode Forward Voltage

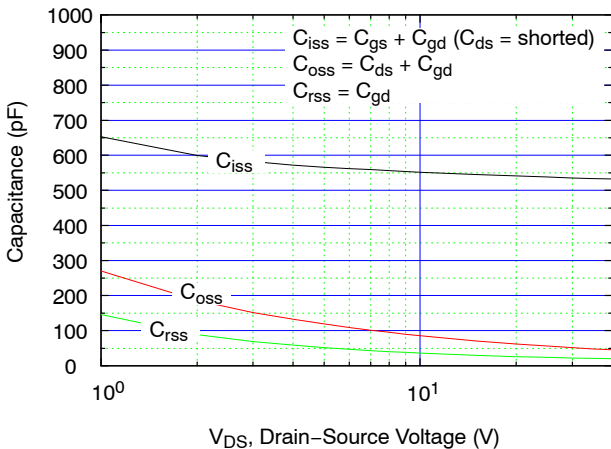

Figure 6. Capacitance vs. Drain-Source Voltage

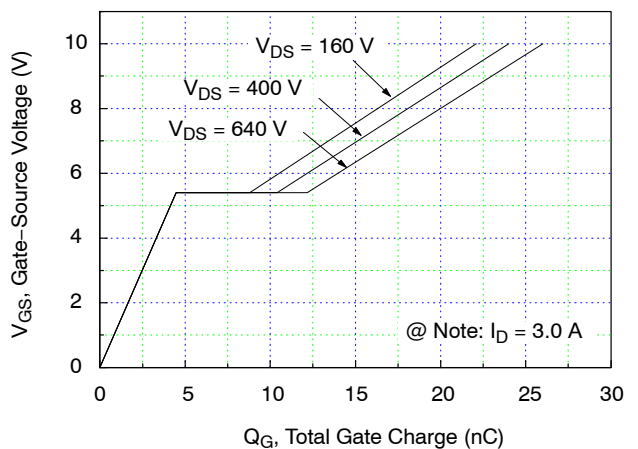

Figure 7. Gate Charge vs. Gate-Source Voltage

TYPICAL PERFORMANCE CHARACTERISTICS (continued)

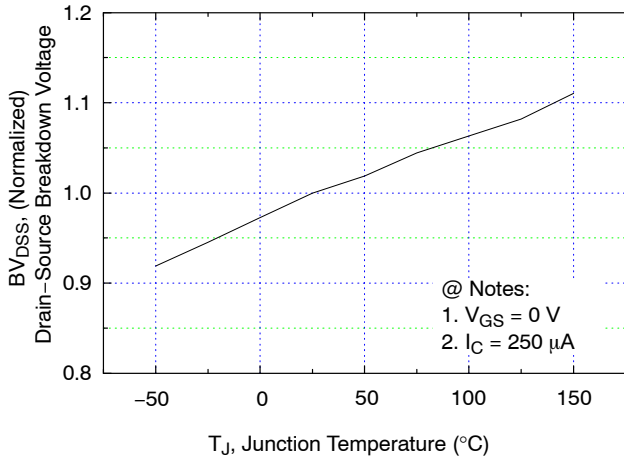

Figure 8. Breakdown Voltage vs. Temperature

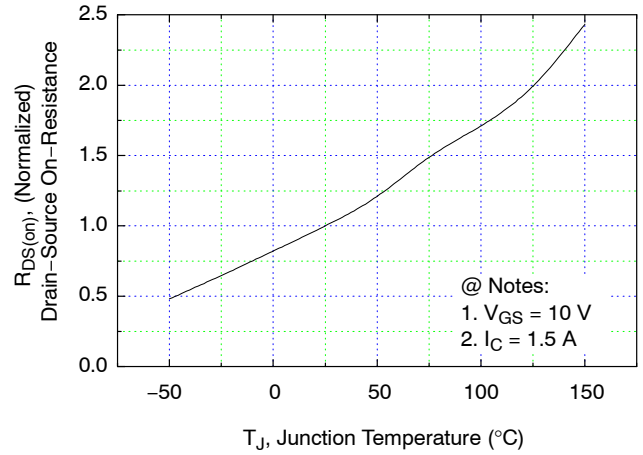

Figure 9. On-Resistance vs. Temperature

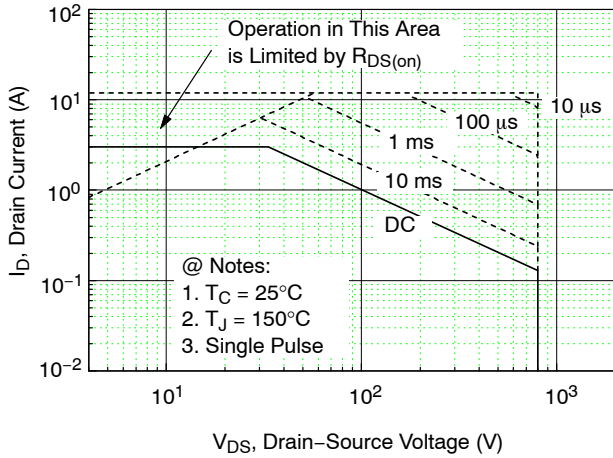

Figure 10. Max. Safe Operating Area

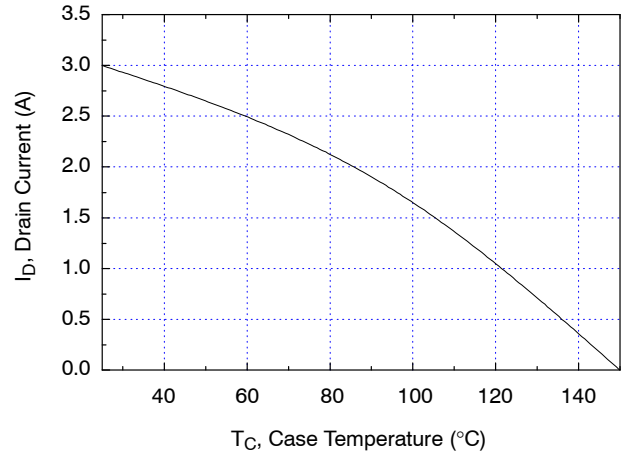

Figure 11. Max. Drain Current vs. Case Temperature

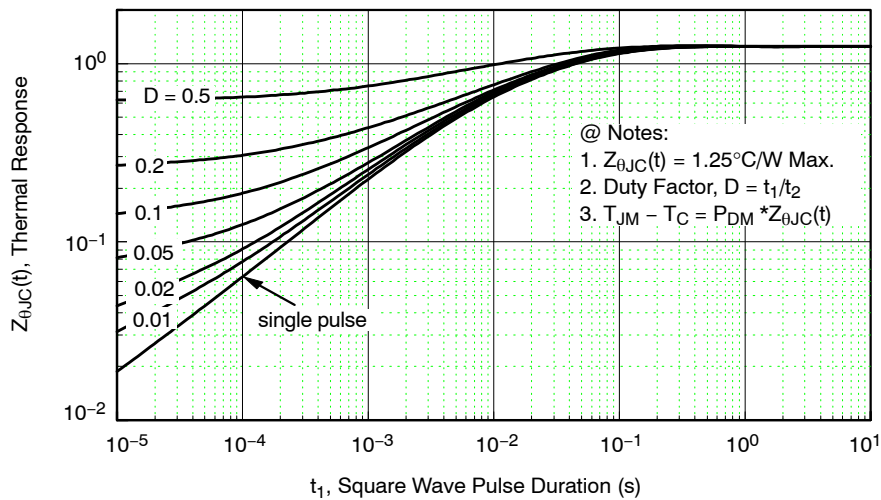

Figure 12. Thermal Response

KA5L0380R

TYPICAL PERFORMANCE CHARACTERISTICS (Control part)

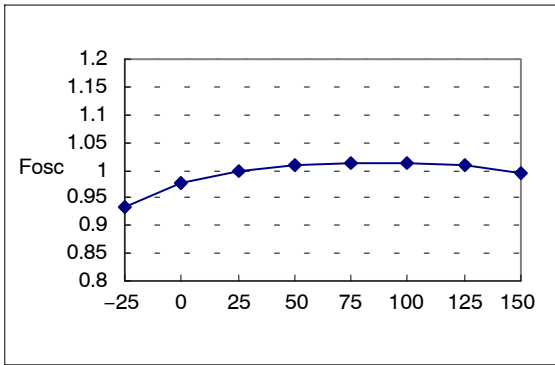

Figure 13. Operating Frequency

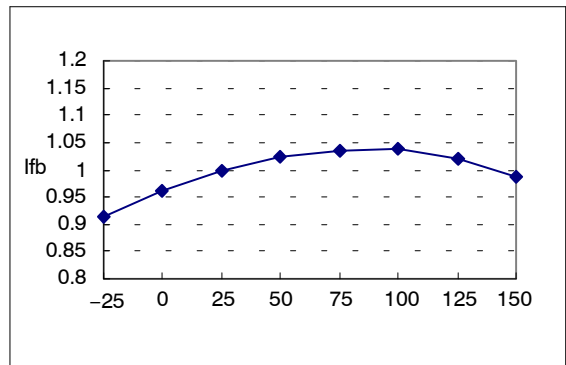

Figure 14. Feedback Source Current

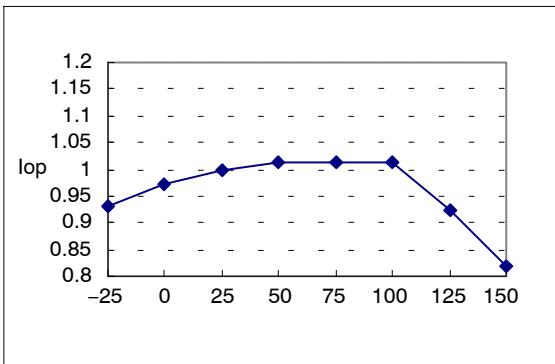

Figure 15. Operating Current

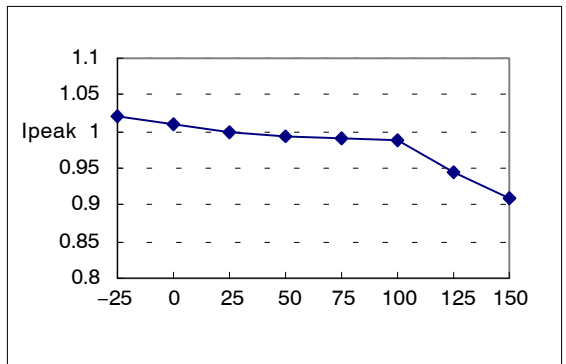

Figure 16. Max Inductor Current

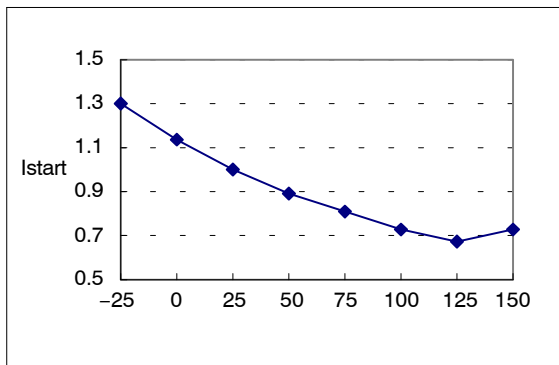

Figure 17. Start Up Current

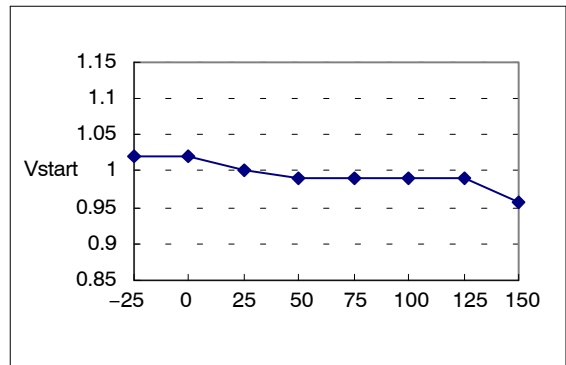

Figure 18. Start Threshold Voltage

KA5L0380R

TYPICAL PERFORMANCE CHARACTERISTICS (continued)

(These characteristic graphs are normalized at $T_a = 25^\circ\text{C}$)

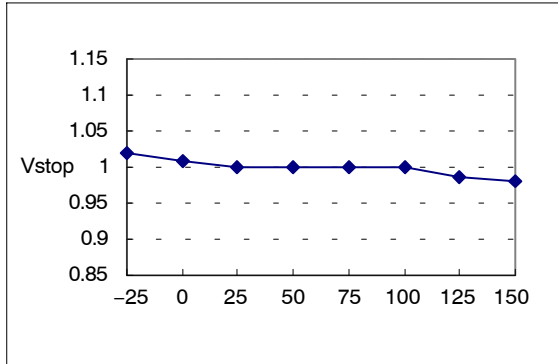

Figure 19. Stop Threshold Voltage

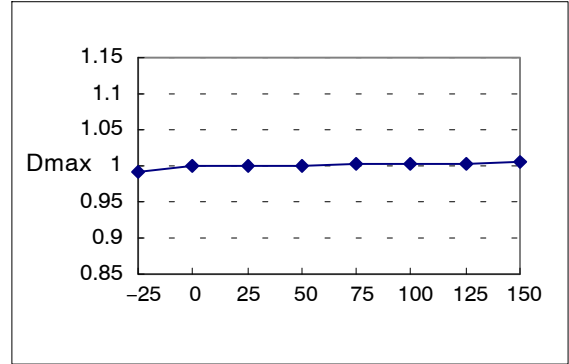

Figure 20. Maximum Duty Cycle

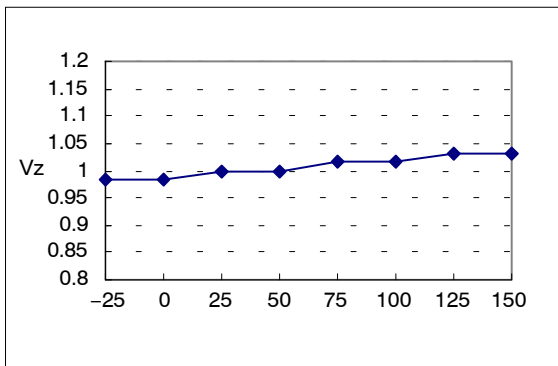

Figure 21. Vcc Zener Voltage

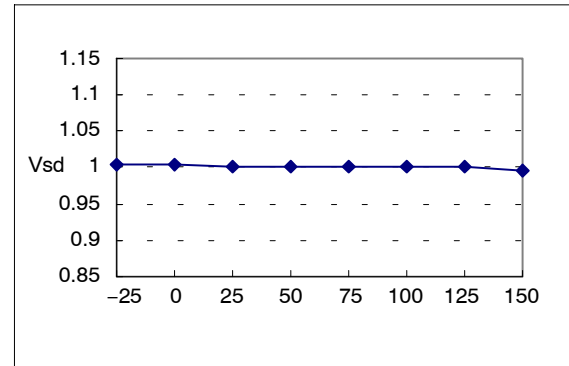

Figure 22. Shutdown Feedback Voltage

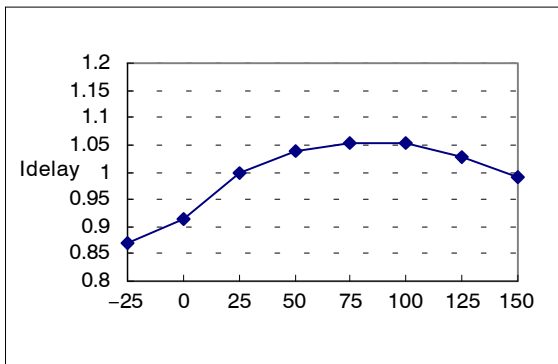

Figure 23. Shutdown Delay Current

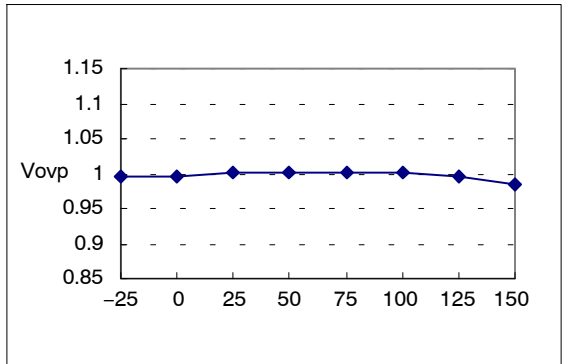

Figure 24. Over Voltage Protection

TYPICAL PERFORMANCE CHARACTERISTICS (continued)

(These characteristic graphs are normalized at Ta = 25°C)

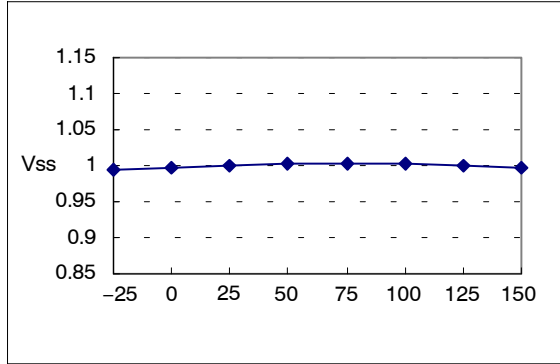

Figure 25. Soft Start Voltage

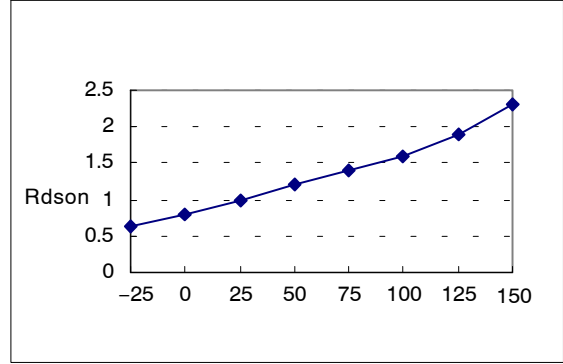

Figure 26. Drain Source Turn-On Resistance

KA5L0380R

ORDERING INFORMATION

Device	Operating Temperature Range	Package	Packing Method
KA5L0380R	-25 to +85°C	TO-220F-4L (Pb-Free)	Tube

SENFET is a registered trademark of Semiconductor Components Industries, LLC dba "onsemi" or its affiliates and/or subsidiaries in the United States and/or other countries.

MECHANICAL CASE OUTLINE
PACKAGE DIMENSIONS

ON Semiconductor®



TO-220 FULLPAK 4LD LF
CASE 340BK
ISSUE O

DATE 31 AUG 2016

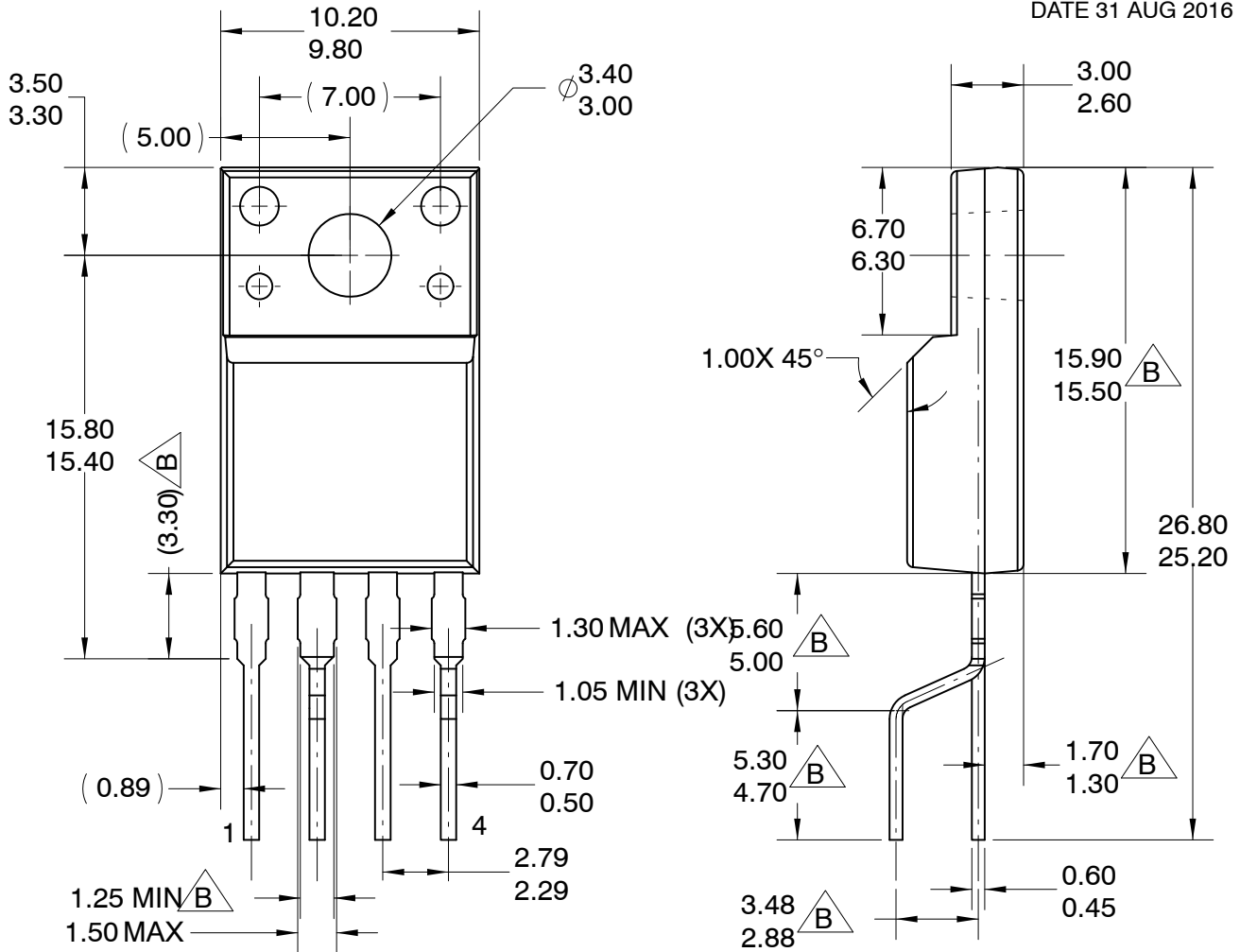

NOTES:

- A. EXCEPT WHERE NOTED CONFORMS TO SC91A.
- B. DOES NOT COMPLY EIAJ STD. VALUE.
- C. ALL DIMENSIONS ARE IN MILLIMETERS.
- D. DIMENSIONS ARE EXCLUSIVE OF BURRS, MOLD FLASH AND TIE BAR PROTRUSIONS.
- E. PIN 2 CONNECTS TO DAP.

DOCUMENT NUMBER:	98AON13843G	Electronic versions are uncontrolled except when accessed directly from the Document Repository. Printed versions are uncontrolled except when stamped "CONTROLLED COPY" in red.
DESCRIPTION:	TO-220 FULLPAK 4LD LF	PAGE 1 OF 1

ON Semiconductor and ON are trademarks of Semiconductor Components Industries, LLC dba ON Semiconductor or its subsidiaries in the United States and/or other countries. ON Semiconductor reserves the right to make changes without further notice to any products herein. ON Semiconductor makes no warranty, representation or guarantee regarding the suitability of its products for any particular purpose, nor does ON Semiconductor assume any liability arising out of the application or use of any product or circuit, and specifically disclaims any and all liability, including without limitation special, consequential or incidental damages. ON Semiconductor does not convey any license under its patent rights nor the rights of others.

onsemi, **Onsemi**, and other names, marks, and brands are registered and/or common law trademarks of Semiconductor Components Industries, LLC dba "**onsemi**" or its affiliates and/or subsidiaries in the United States and/or other countries. **onsemi** owns the rights to a number of patents, trademarks, copyrights, trade secrets, and other intellectual property. A listing of **onsemi**'s product/patent coverage may be accessed at www.onsemi.com/site/pdf/Patent-Marking.pdf. **onsemi** reserves the right to make changes at any time to any products or information herein, without notice. The information herein is provided "as-is" and **onsemi** makes no warranty, representation or guarantee regarding the accuracy of the information, product features, availability, functionality, or suitability of its products for any particular purpose, nor does **onsemi** assume any liability arising out of the application or use of any product or circuit, and specifically disclaims any and all liability, including without limitation special, consequential or incidental damages. Buyer is responsible for its products and applications using **onsemi** products, including compliance with all laws, regulations and safety requirements or standards, regardless of any support or applications information provided by **onsemi**. "Typical" parameters which may be provided in **onsemi** data sheets and/or specifications can and do vary in different applications and actual performance may vary over time. All operating parameters, including "Typicals" must be validated for each customer application by customer's technical experts. **onsemi** does not convey any license under any of its intellectual property rights nor the rights of others. **onsemi** products are not designed, intended, or authorized for use as a critical component in life support systems or any FDA Class 3 medical devices or medical devices with a same or similar classification in a foreign jurisdiction or any devices intended for implantation in the human body. Should Buyer purchase or use **onsemi** products for any such unintended or unauthorized application, Buyer shall indemnify and hold **onsemi** and its officers, employees, subsidiaries, affiliates, and distributors harmless against all claims, costs, damages, and expenses, and reasonable attorney fees arising out of, directly or indirectly, any claim of personal injury or death associated with such unintended or unauthorized use, even if such claim alleges that **onsemi** was negligent regarding the design or manufacture of the part. **onsemi** is an Equal Opportunity/Affirmative Action Employer. This literature is subject to all applicable copyright laws and is not for resale in any manner.

ADDITIONAL INFORMATION

TECHNICAL PUBLICATIONS:

Technical Library: www.onsemi.com/design/resources/technical-documentation
onsemi Website: www.onsemi.com

ONLINE SUPPORT: www.onsemi.com/support

For additional information, please contact your local Sales Representative at www.onsemi.com/support/sales