

# NPN Epitaxial Silicon Transistor

## KSC1008

### Features

- Low-Frequency Amplifier Medium Speed Switching
- High Collector-Base Voltage:  $V_{CBO} = 80\text{ V}$
- Collector Current:  $I_C = 700\text{ mA}$
- Suffix “-C” means Center Collector (1. Emitter 2. Collector 3. Base)
- Non Suffix “-C” means Side Collector (1. Emitter 2. Base 3. Collector)
- Complement to KSA708
- These are Pb-Free Devices

### ABSOLUTE MAXIMUM RATINGS

( $T_A = 25^\circ\text{C}$  unless otherwise noted.)

Symbol	Parameter	Value	Unit
$V_{CBO}$	Collector-Base Voltage	80	V
$V_{CEO}$	Collector-Emitter Voltage	60	V
$V_{EBO}$	Emitter-Base Voltage	8	V
$I_C$	Collector Current	700	mA
$T_J$	Junction Temperature	150	$^\circ\text{C}$
$T_{STG}$	Storage Temperature	-55 to 150	$^\circ\text{C}$

Stresses exceeding those listed in the Maximum Ratings table may damage the device. If any of these limits are exceeded, device functionality should not be assumed, damage may occur and reliability may be affected.

### THERMAL CHARACTERISTICS

( $T_A = 25^\circ\text{C}$  unless otherwise noted.) (Note 1)

Symbol	Parameter	Value	Unit
$P_D$	Power Dissipation	800	mW
	Derate Above $25^\circ\text{C}$	6.4	mW/ $^\circ\text{C}$
$R_{\theta JA}$	Thermal Resistance, Junction-to-Ambient	156	$^\circ\text{C}/\text{W}$

1. PCB size: FR-4, 76 mm  $\times$  114 mm  $\times$  1.57 mm (3.0 inch  $\times$  4.5 inch  $\times$  0.062 inch) with minimum land pattern size.

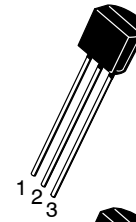

TO-92-3  
CASE 135AN

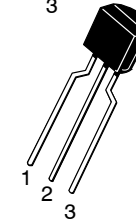

TO-92-3 LF  
CASE 135AR

KSC1008: 1. Emitter 2. Base 3. Collector  
 KSC1008C: 1. Emitter 2. Collector 3. Base

### MARKING DIAGRAM

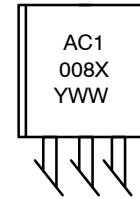

A = Assembly Code  
 C1008 = Device Code  
 X = O/Y/YC/G  
 YWW = Date Code

### ORDERING INFORMATION

See detailed ordering and shipping information on page 2 of this data sheet.

# KSC1008

## ELECTRICAL CHARACTERISTICS ( $T_A = 25^\circ\text{C}$ unless otherwise noted)

Symbol	Parameter	Conditions	Min	Typ	Max	Unit
$BV_{CBO}$	Collector-Base Breakdown Voltage	$I_C = 100\ \mu\text{A}$ , $I_E = 0$	80	-	-	V
$BV_{CEO}$	Collector-Emitter Breakdown Voltage	$I_C = 10\ \text{mA}$ , $I_B = 0$	60	-	-	V
$BV_{EBO}$	Emitter-Base Breakdown Voltage	$I_E = 10\ \mu\text{A}$ , $I_C = 0$	8	-	-	V
$I_{CBO}$	Collector Cut-Off Current	$V_{CB} = 60\ \text{V}$ , $I_E = 0$	-	-	0.1	$\mu\text{A}$
$I_{EBO}$	Emitter Cut-Off Current	$V_{EB} = 5\ \text{V}$ , $I_C = 0$	-	-	0.1	$\mu\text{A}$
$h_{FE}$	DC Current Gain	$V_{CE} = 2\ \text{V}$ , $I_C = 50\ \text{mA}$	40	-	400	
$V_{CE(sat)}$	Collector-Emitter Saturation Voltage	$I_C = 500\ \text{mA}$ , $I_B = 50\ \text{mA}$	-	0.2	0.4	V
$V_{BE(sat)}$	Base-Emitter Saturation Voltage	$I_C = 500\ \text{mA}$ , $I_B = 50\ \text{mA}$	-	0.86	1.10	V
$f_T$	Current Gain Bandwidth Product	$V_{CE} = 10\ \text{V}$ , $I_C = 50\ \text{mA}$	30	50	-	MHz
$C_{ob}$	Output Capacitance	$V_{CB} = 10\ \text{V}$ , $I_E = 0$ , $f = 1\ \text{MHz}$	-	8	-	pF

Product parametric performance is indicated in the Electrical Characteristics for the listed test conditions, unless otherwise noted. Product performance may not be indicated by the Electrical Characteristics if operated under different conditions.

## $h_{FE}$ Classification

Classification	O	Y	G
$h_{FE}$	70 ~ 140	120 ~ 240	200 ~ 400

## ORDERING INFORMATION (Note 2)

Part Number	Top Mark	Package	Shipping
KSC1008OBU	C1008 O-	TO-92-3 (Pb-Free)	10000 / Bulk Bag
KSC1008YBU	C1008 Y-		10000 / Bulk Bag
KSC1008YTA	C1008 Y-	TO-92-3 LR (Pb-Free)	2000 / Fan-Fold
KSC1008CYTA	C1008 YC		2000 / Fan-Fold
KSC1008GTA	C1008 G-		2000 / Fan-Fold

2. Affix "-C-" means center collector pin. Affix "-O-", "-Y-", "-G-" means  $h_{FE}$  classification. Suffix "-BU" means bulk packing, straight lead form. Suffix "-TA" means tape and ammo packing, 0.200 in-line spacing lead form.

TYPICAL PERFORMANCE CHARACTERISTICS

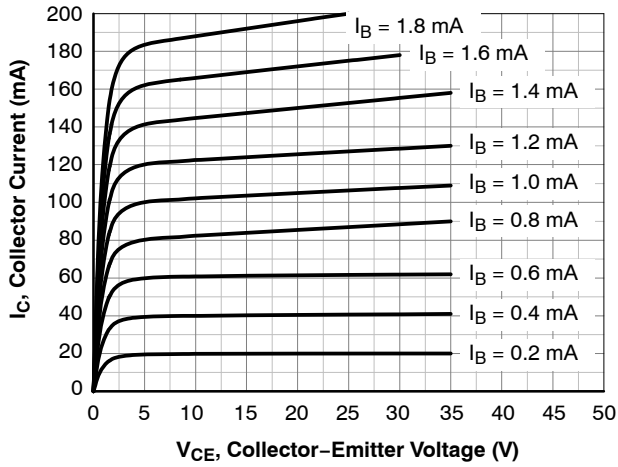

Figure 1. Static Characteristic

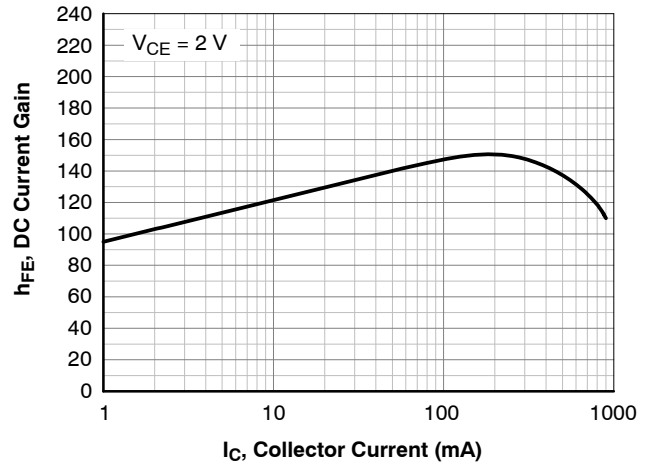

Figure 2. DC Current Gain

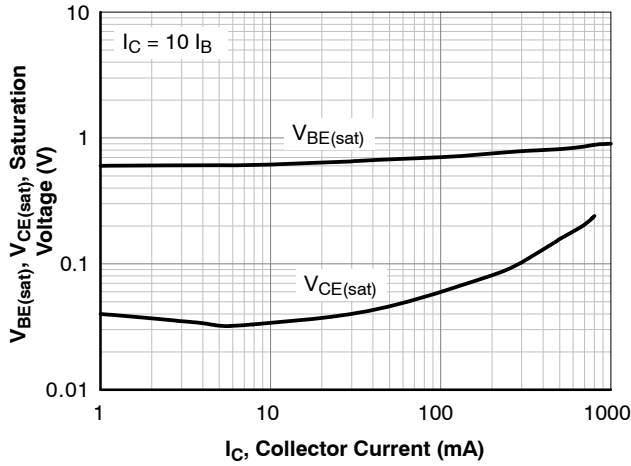

Figure 3. Base-Emitter Saturation Voltage and Collector-Emitter Saturation Voltage

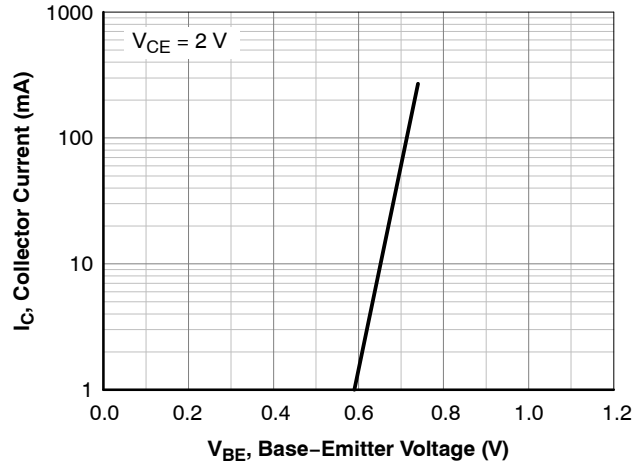

Figure 4. Base-Emitter On Voltage

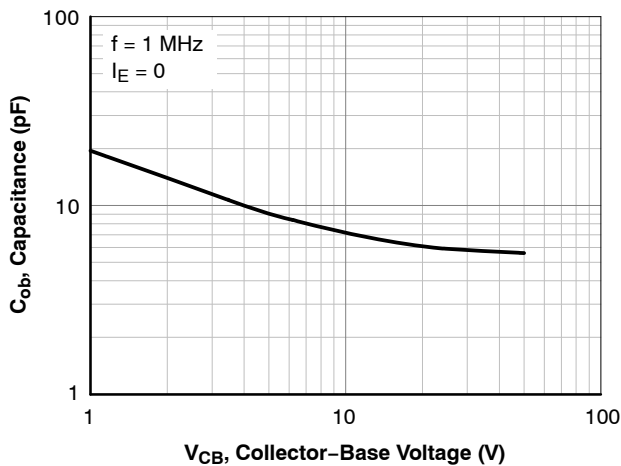
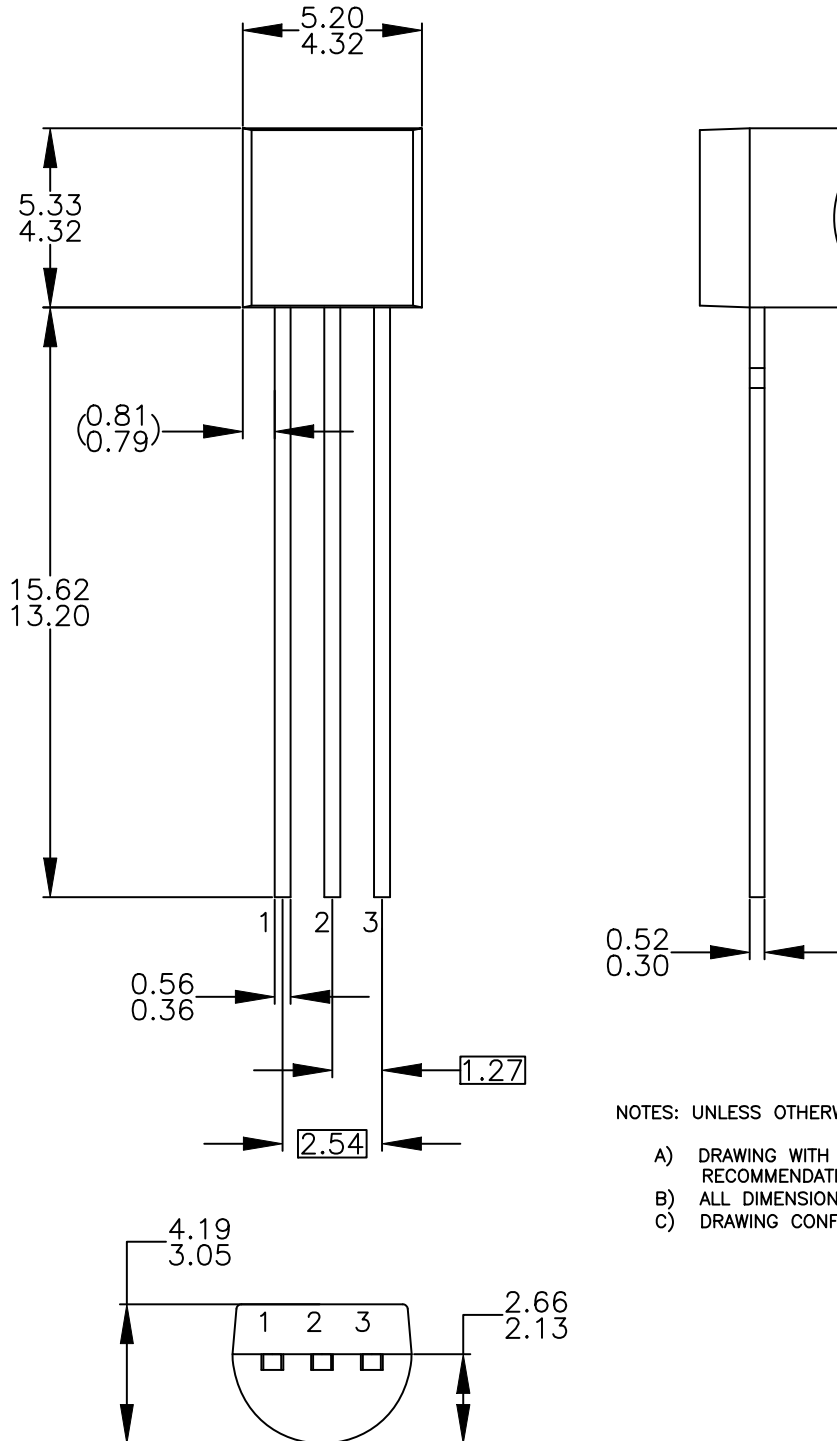

Figure 5. Collector Output Capacitance

**MECHANICAL CASE OUTLINE**  
**PACKAGE DIMENSIONS**

TO-92 3 4.825x4.76  
CASE 135AN  
ISSUE O

DATE 31 JUL 2016



NOTES: UNLESS OTHERWISE SPECIFIED

- A) DRAWING WITH REFERENCE TO JEDEC TO-92 RECOMMENDATIONS.
- B) ALL DIMENSIONS ARE IN MILLIMETERS.
- C) DRAWING CONFORMS TO ASME Y14.5M-2009.

<b>DOCUMENT NUMBER:</b>	<b>98AON13880G</b>	Electronic versions are uncontrolled except when accessed directly from the Document Repository. Printed versions are uncontrolled except when stamped "CONTROLLED COPY" in red.
<b>DESCRIPTION:</b>	<b>TO-92 3 4.825X4.76</b>	<b>PAGE 1 OF 1</b>

ON Semiconductor and **ON** are trademarks of Semiconductor Components Industries, LLC dba ON Semiconductor or its subsidiaries in the United States and/or other countries. ON Semiconductor reserves the right to make changes without further notice to any products herein. ON Semiconductor makes no warranty, representation or guarantee regarding the suitability of its products for any particular purpose, nor does ON Semiconductor assume any liability arising out of the application or use of any product or circuit, and specifically disclaims any and all liability, including without limitation special, consequential or incidental damages. ON Semiconductor does not convey any license under its patent rights nor the rights of others.

**MECHANICAL CASE OUTLINE**  
**PACKAGE DIMENSIONS**

**TO-92 3 4.83x4.76 LEADFORMED**  
**CASE 135AR**  
**ISSUE O**

DATE 30 SEP 2016



NOTES: UNLESS OTHERWISE SPECIFIED

- A) DRAWING WITH REFERENCE TO JEDEC TO-92 RECOMMENDATIONS.
- B) ALL DIMENSIONS ARE IN MILLIMETERS.
- C) DRAWING CONFORMS TO ASME Y14.5M-1994

<b>DOCUMENT NUMBER:</b>	<b>98AON13879G</b>	Electronic versions are uncontrolled except when accessed directly from the Document Repository. Printed versions are uncontrolled except when stamped "CONTROLLED COPY" in red.
<b>DESCRIPTION:</b>	<b>TO-92 3 4.83X4.76 LEADFORMED</b>	<b>PAGE 1 OF 1</b>

ON Semiconductor and  are trademarks of Semiconductor Components Industries, LLC dba ON Semiconductor or its subsidiaries in the United States and/or other countries. ON Semiconductor reserves the right to make changes without further notice to any products herein. ON Semiconductor makes no warranty, representation or guarantee regarding the suitability of its products for any particular purpose, nor does ON Semiconductor assume any liability arising out of the application or use of any product or circuit, and specifically disclaims any and all liability, including without limitation special, consequential or incidental damages. ON Semiconductor does not convey any license under its patent rights nor the rights of others.

**onsemi**, **Onsemi**, and other names, marks, and brands are registered and/or common law trademarks of Semiconductor Components Industries, LLC dba "**onsemi**" or its affiliates and/or subsidiaries in the United States and/or other countries. **onsemi** owns the rights to a number of patents, trademarks, copyrights, trade secrets, and other intellectual property. A listing of **onsemi**'s product/patent coverage may be accessed at [www.onsemi.com/site/pdf/Patent-Marking.pdf](http://www.onsemi.com/site/pdf/Patent-Marking.pdf). **onsemi** reserves the right to make changes at any time to any products or information herein, without notice. The information herein is provided "as-is" and **onsemi** makes no warranty, representation or guarantee regarding the accuracy of the information, product features, availability, functionality, or suitability of its products for any particular purpose, nor does **onsemi** assume any liability arising out of the application or use of any product or circuit, and specifically disclaims any and all liability, including without limitation special, consequential or incidental damages. Buyer is responsible for its products and applications using **onsemi** products, including compliance with all laws, regulations and safety requirements or standards, regardless of any support or applications information provided by **onsemi**. "Typical" parameters which may be provided in **onsemi** data sheets and/or specifications can and do vary in different applications and actual performance may vary over time. All operating parameters, including "Typicals" must be validated for each customer application by customer's technical experts. **onsemi** does not convey any license under any of its intellectual property rights nor the rights of others. **onsemi** products are not designed, intended, or authorized for use as a critical component in life support systems or any FDA Class 3 medical devices or medical devices with a same or similar classification in a foreign jurisdiction or any devices intended for implantation in the human body. Should Buyer purchase or use **onsemi** products for any such unintended or unauthorized application, Buyer shall indemnify and hold **onsemi** and its officers, employees, subsidiaries, affiliates, and distributors harmless against all claims, costs, damages, and expenses, and reasonable attorney fees arising out of, directly or indirectly, any claim of personal injury or death associated with such unintended or unauthorized use, even if such claim alleges that **onsemi** was negligent regarding the design or manufacture of the part. **onsemi** is an Equal Opportunity/Affirmative Action Employer. This literature is subject to all applicable copyright laws and is not for resale in any manner.

---

## ADDITIONAL INFORMATION

### TECHNICAL PUBLICATIONS:

Technical Library: [www.onsemi.com/design/resources/technical-documentation](http://www.onsemi.com/design/resources/technical-documentation)  
onsemi Website: [www.onsemi.com](http://www.onsemi.com)

### ONLINE SUPPORT: [www.onsemi.com/support](http://www.onsemi.com/support)

For additional information, please contact your local Sales Representative at [www.onsemi.com/support/sales](http://www.onsemi.com/support/sales)