

# Programmable Shunt Regulator

## LM431A, LM431B, LM431C

### Description

The LM431A/LM431B/LM431C are three-terminal output adjustable regulators with thermal stability over the full operating temperature range. The output voltage can be set to any value between  $V_{REF}$  (approximately 2.5 V) and 36 V with two external resistors. These devices have a typical dynamic output impedance of 0.2  $\Omega$ . Active output circuit provides a sharp turn-on characteristic, making these devices excellent replacements for Zener diodes in many applications.

### Features

- Programmable Output Voltage to 36 V
- Low Dynamic Output Impedance: 0.2  $\Omega$  (Typical)
- Sink Current Capability: 1.0 to 100 mA
- Equivalent Full-Range Temperature Coefficient of 50 ppm/ $^{\circ}$ C (Typical)
- Temperature Compensated for Operation Over Full Rated Operating Temperature Range
- Low Output Noise Voltage
- Fast Turn-on Response

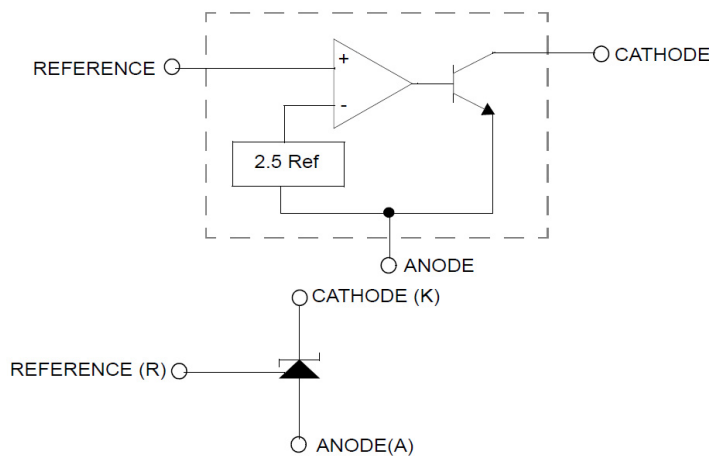
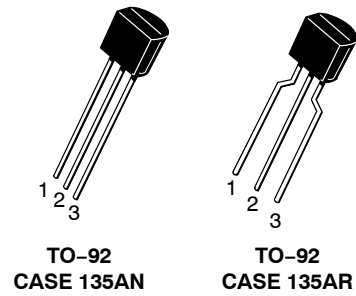
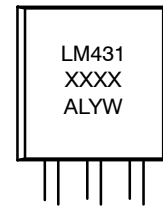

Figure 1. Block Diagram



### MARKING DIAGRAM



- |           |                        |
|-----------|------------------------|
| LM431XXXX | = Specific Device Code |
| A         | = Assembly Location    |
| L         | = Wafer Lot            |
| YW        | = Assembly Start Week  |

### PIN CONNECTIONS

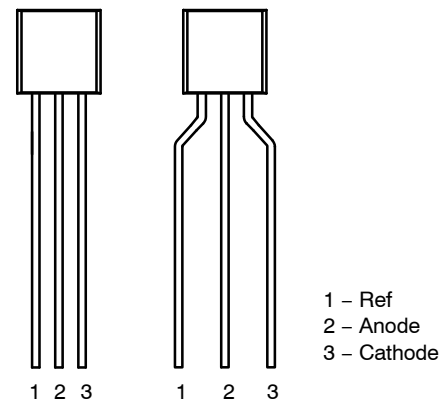

### ORDERING INFORMATION

See detailed ordering and shipping information in the package dimensions section on page 7 of this data sheet.

NOTE: Some of the devices on this data sheet have been **DISCONTINUED**. Please refer to the table on page 7.

# LM431A, LM431B, LM431C

## ABSOLUTE MAXIMUM RATINGS

Symbol	Parameter	Value	Unit
$V_{KA}$	Cathode Voltage	37	V
$I_{KA}$	Cathode Current Range (Continuous)	-100 to +150	mA
$I_{REF}$	Reference Input Current Range	-0.05 to +10	mA
$P_D$	Power Dissipation	770	mW
$R_{\theta JA}$	Thermal Resistance, Junction to Ambient	160	°C/W
$T_{OPR}$	Operating Temperature Range – LM431xC	-25 to +85	°C
	Operating Temperature Range – LM431xI	-40 to +85	°C
$T_J$	Junction Temperature	150	°C
$T_{STG}$	Storage Temperature Range	-65 to +150	°C

Stresses exceeding those listed in the Maximum Ratings table may damage the device. If any of these limits are exceeded, device functionality should not be assumed, damage may occur and reliability may be affected.

## RECOMMENDED OPERATING CONDITIONS

Symbol	Parameter	Min	Max	Unit
$V_{KA}$	Cathode Voltage	$V_{REF}$	36	V
$I_{KA}$	Cathode Current	1.0	100	mA

Functional operation above the stresses listed in the Recommended Operating Ranges is not implied. Extended exposure to stresses beyond the Recommended Operating Ranges limits may affect device reliability.

## ELECTRICAL CHARACTERISTICS (Values are at $T_A = 25^\circ\text{C}$ unless otherwise noted)

Symbol	Parameter	Conditions	LM431A			LM431B			LM431C			Unit	
			Min	Typ	Max	Min	Typ	Max	Min	Typ	Max		
$V_{REF}$	Reference Input Voltage	$V_{KA} = V_{REF}, I_{KA} = 10\text{ mA}$	2.450	2.500	2.550	2.470	2.495	2.520	2.482	2.495	2.508	V	
$\Delta V_{REF}/\Delta T$	Deviation of Reference Input Voltage Over-Temperature	$V_{KA} = V_{REF}, I_{KA} = 10\text{ mA}$ $T_{MIN} \leq T_A \leq T_{MAX}$ (Note 1)	-	4.5	17.0	-	4.5	17.0	-	4.5	17.0	mV	
$\Delta V_{REF}/\Delta V_{KA}$	Ratio of Change in Reference Input Voltage to the Change in Cathode Voltage	$I_{KA} = 10\text{ mA}$	$\Delta V_{KA} = 10\text{ V} - V_{REF}$	-	-1.0	-2.7	-	-1.0	-2.7	-	-1.0	-2.7	mV/V
			$\Delta V_{KA} = 36\text{ V} - 10\text{ V}$	-	-0.5	-2.0	-	-0.5	-2.0	-	-0.5	-2.0	
$I_{REF}$	Reference Input Current	$I_{KA} = 10\text{ mA}, R_1 = 10\text{ k}\Omega, R_2 = \infty$	-	1.5	4.0	-	1.5	4.0	-	1.5	4.0	$\mu\text{A}$	
$\Delta I_{REF}/\Delta T$	Deviation of Reference Input Current Over Full Temperature Range	$I_{KA} = 10\text{ mA}, R_1 = 10\text{ k}\Omega, R_2 = \infty, T_A = \text{Full Range}$	-	0.4	1.2	-	0.4	1.2	-	0.4	1.2	$\mu\text{A}$	
$I_{KA(MIN)}$	Minimum Cathode Current for Regulation	$V_{KA} = V_{REF}$	-	0.45	1.00	-	0.45	1.00	-	0.45	1.00	mA	
$I_{KA(OFF)}$	Off – Stage Cathode Current	$V_{KA} = 36\text{ V}, V_{REF} = 0$	-	0.05	1.00	-	0.05	1.00	-	0.05	1.00	$\mu\text{A}$	
$Z_{KA}$	Dynamic Impedance	$V_{KA} = V_{REF}, I_{KA} = 1\text{ to }100\text{ mA}$ , $f \geq 1.0\text{ kHz}$	-	0.15	0.50	-	0.15	0.50	-	0.15	0.50	$\Omega$	

Product parametric performance is indicated in the Electrical Characteristics for the listed test conditions, unless otherwise noted. Product performance may not be indicated by the Electrical Characteristics if operated under different conditions.

- LM431xC:  $T_{MIN} = -25^\circ\text{C}$ ,  $T_{MAX} = +85^\circ\text{C}$   
LM431xI:  $T_{MIN} = -40^\circ\text{C}$ ,  $T_{MAX} = +85^\circ\text{C}$

# LM431A, LM431B, LM431C

## TEST CIRCUIT

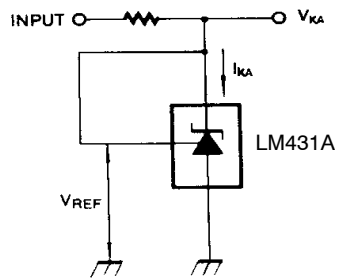

Figure 2. Test Circuit for  $V_{KA} = V_{REF}$

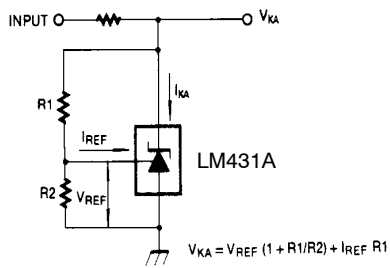

Figure 3. Test Circuit for  $V_{KA} \geq V_{REF}$

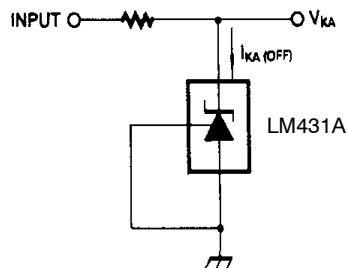

Figure 4. Test Circuit for  $I_{KA(OFF)}$

# LM431A, LM431B, LM431C

## TYPICAL PERFORMANCE CHARACTERISTICS

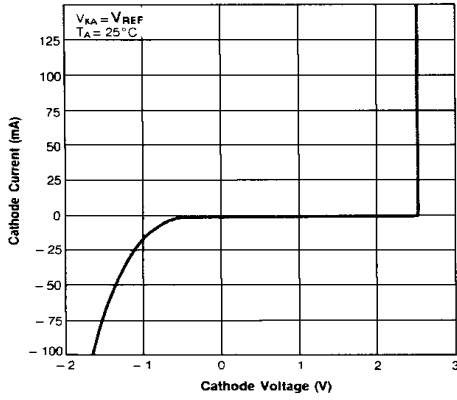

Figure 5. Cathode Current vs. Cathode Voltage

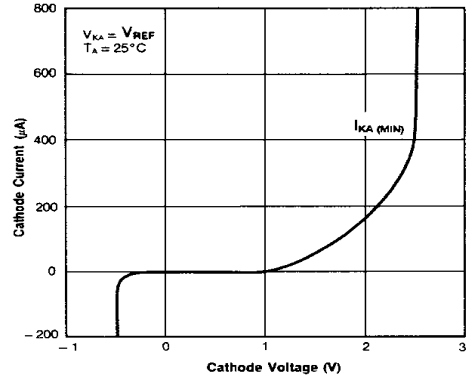

Figure 6. Cathode Current vs. Cathode Voltage

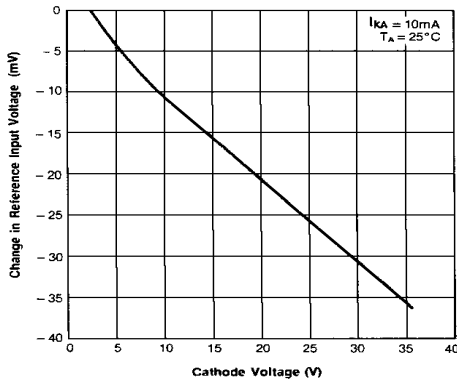

Figure 7. Change in Reference Input Voltage vs. Cathode Voltage

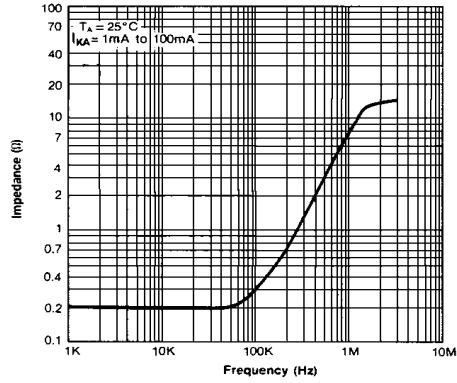

Figure 8. Dynamic Impedance Frequency

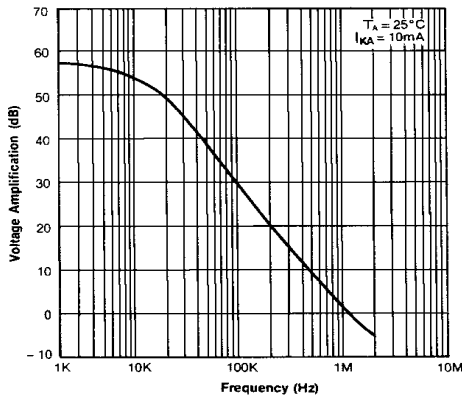

Figure 9. Small Signal Voltage Amplification vs. Frequency

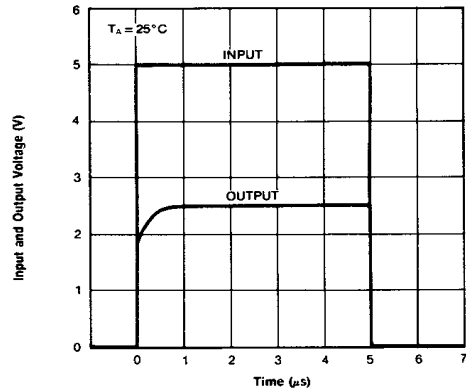

Figure 10. Pulse Response

# LM431A, LM431B, LM431C

## TYPICAL PERFORMANCE CHARACTERISTICS (CONTINUED)

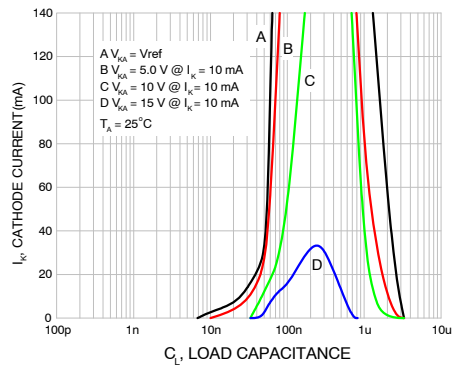

Figure 11. Stability Boundary Conditions

# LM431A, LM431B, LM431C

## TYPICAL APPLICATION

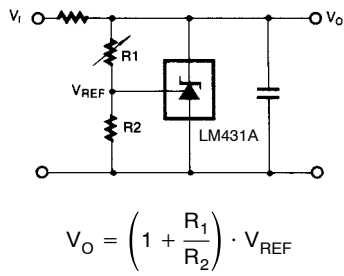

Figure 12. Shunt Regulator

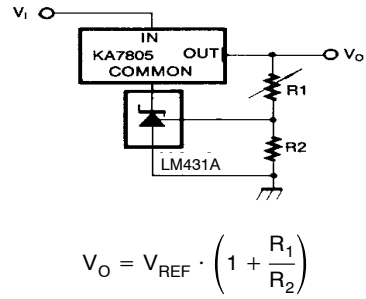

Figure 13. Output Control for Three-Terminal Fixed Regulator

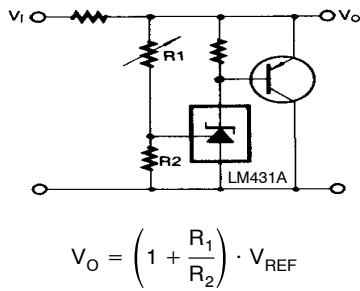

Figure 14. High-Current Shunt Regulator

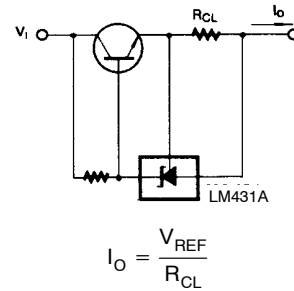

Figure 15. Current Limit or Current Source

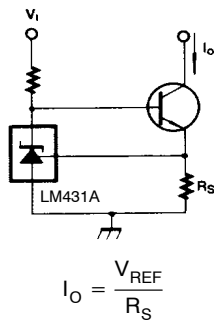

Figure 16. Constant-Current Sink

## LM431A, LM431B, LM431C

### ORDERING INFORMATION

Part Number	Operating Temperature Range	Output Voltage Tolerance	Tom Mark	Package	Packing Method <sup>†</sup>
LM431AIZ	-40 ~ +85°C	2%	LM431AIZ	TO-92	Bulk

### DISCONTINUED (Note 2)

LM431CCZ	-25 ~ +85°C	0.5%	LM431CCZ	TO-92	Bulk
LM431BCZX		1%	LM431BCZ	TO-92	Tape and Reel
LM431BCZXA			LM431BCZ	TO-92	Ammo
LM431ACZ		2%	LM431ACZ	TO-92	Bulk
LM431ACZX			LM431ACZ	TO-92	Tape and Reel
LM431BIZX	-40 ~ +85°C	1%	LM431BIZ	TO-92	Tape and Reel

<sup>†</sup>For information on tape and reel specifications, including part orientation and tape sizes, please refer to our Tape and Reel Packaging Specifications Brochure, BRD8011/D.

2. **DISCONTINUED:** These devices are not recommended for new design. Please contact your **onsemi** representative for information. The most current information on these devices may be available on [www.onsemi.com](http://www.onsemi.com).

TO-92 3 4.825x4.76  
CASE 135AN  
ISSUE O

DATE 31 JUL 2016

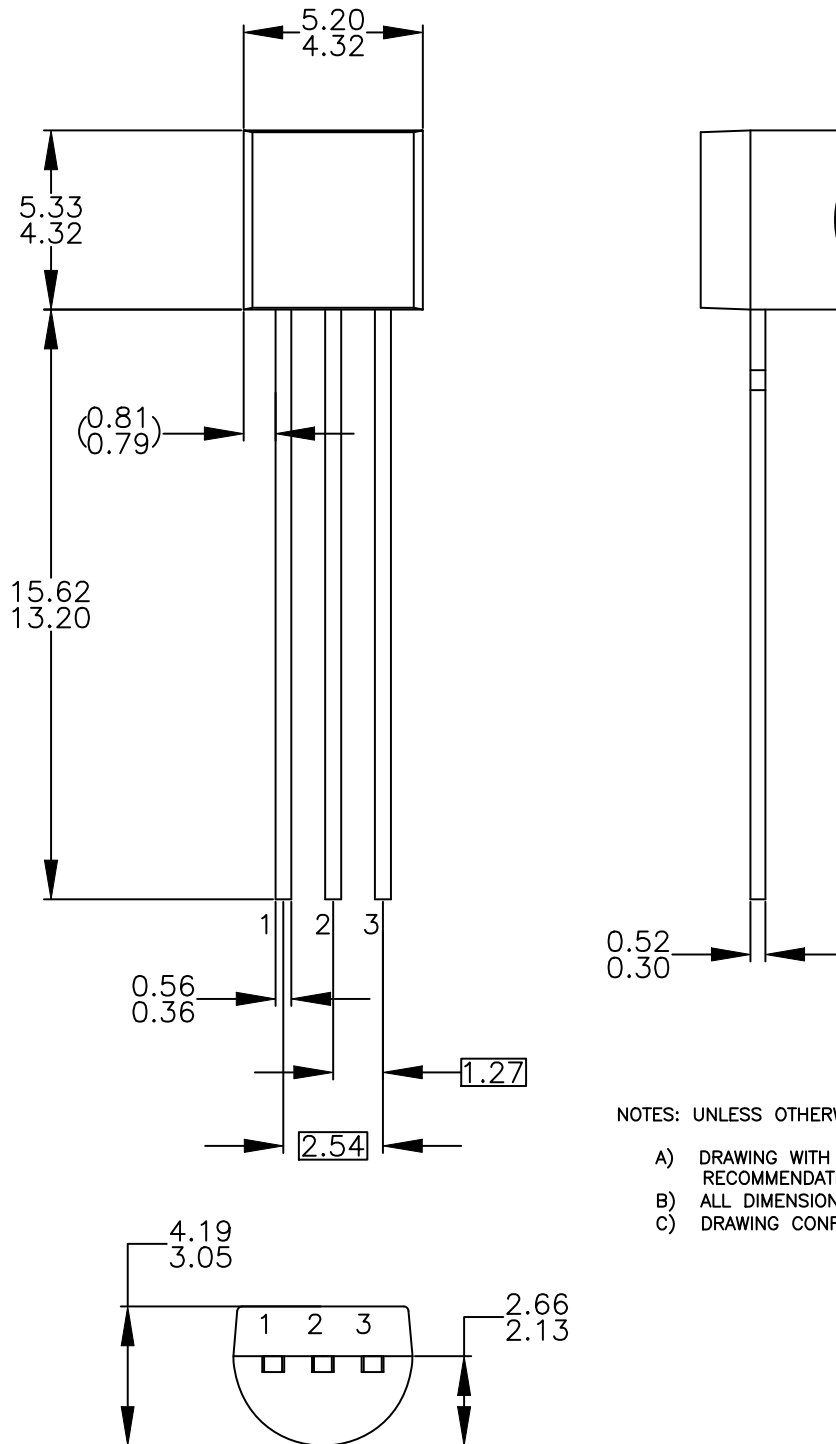

NOTES: UNLESS OTHERWISE SPECIFIED

- A) DRAWING WITH REFERENCE TO JEDEC TO-92 RECOMMENDATIONS.
- B) ALL DIMENSIONS ARE IN MILLIMETERS.
- C) DRAWING CONFORMS TO ASME Y14.5M-2009.

<b>DOCUMENT NUMBER:</b>	<b>98AON13880G</b>	Electronic versions are uncontrolled except when accessed directly from the Document Repository. Printed versions are uncontrolled except when stamped "CONTROLLED COPY" in red.
<b>DESCRIPTION:</b>	<b>TO-92 3 4.825X4.76</b>	<b>PAGE 1 OF 1</b>

onsemi and ONSEMI are trademarks of Semiconductor Components Industries, LLC dba onsemi or its subsidiaries in the United States and/or other countries. onsemi reserves the right to make changes without further notice to any products herein. onsemi makes no warranty, representation or guarantee regarding the suitability of its products for any particular purpose, nor does onsemi assume any liability arising out of the application or use of any product or circuit, and specifically disclaims any and all liability, including without limitation special, consequential or incidental damages. onsemi does not convey any license under its patent rights nor the rights of others.



**TO-92 3 4.83x4.76 LEADFORMED**  
CASE 135AR  
ISSUE O

DATE 30 SEP 2016

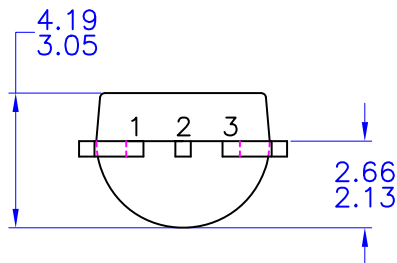
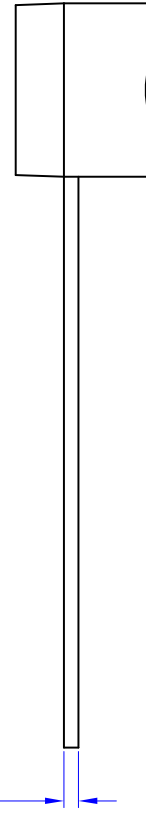
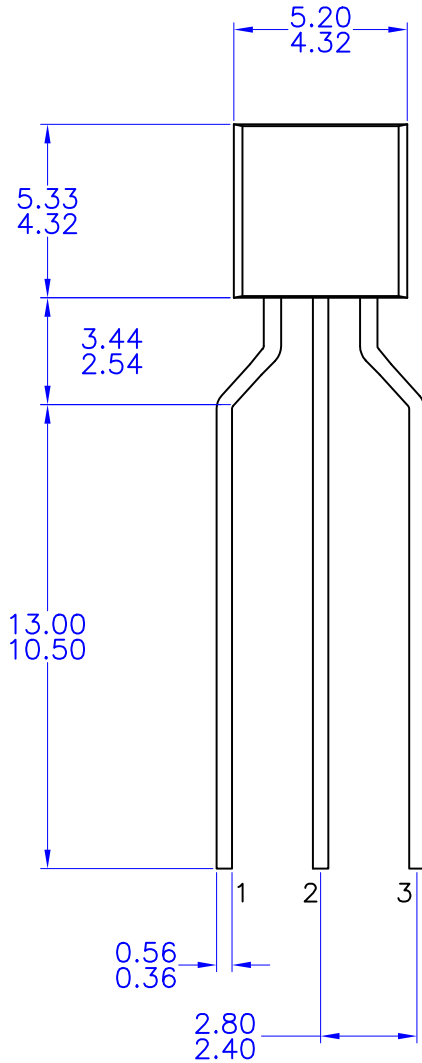

NOTES: UNLESS OTHERWISE SPECIFIED

- A) DRAWING WITH REFERENCE TO JEDEC TO-92 RECOMMENDATIONS.
- B) ALL DIMENSIONS ARE IN MILLIMETERS.
- C) DRAWING CONFORMS TO ASME Y14.5M-1994

<b>DOCUMENT NUMBER:</b>	<b>98AON13879G</b>	Electronic versions are uncontrolled except when accessed directly from the Document Repository. Printed versions are uncontrolled except when stamped "CONTROLLED COPY" in red.
<b>DESCRIPTION:</b>	<b>TO-92 3 4.83X4.76 LEADFORMED</b>	<b>PAGE 1 OF 1</b>

onsemi and ONSEMI are trademarks of Semiconductor Components Industries, LLC dba onsemi or its subsidiaries in the United States and/or other countries. onsemi reserves the right to make changes without further notice to any products herein. onsemi makes no warranty, representation or guarantee regarding the suitability of its products for any particular purpose, nor does onsemi assume any liability arising out of the application or use of any product or circuit, and specifically disclaims any and all liability, including without limitation special, consequential or incidental damages. onsemi does not convey any license under its patent rights nor the rights of others.

**onsemi**, **Onsemi**, and other names, marks, and brands are registered and/or common law trademarks of Semiconductor Components Industries, LLC dba "**onsemi**" or its affiliates and/or subsidiaries in the United States and/or other countries. **onsemi** owns the rights to a number of patents, trademarks, copyrights, trade secrets, and other intellectual property. A listing of **onsemi**'s product/patent coverage may be accessed at [www.onsemi.com/site/pdf/Patent-Marking.pdf](http://www.onsemi.com/site/pdf/Patent-Marking.pdf). **onsemi** reserves the right to make changes at any time to any products or information herein, without notice. The information herein is provided "as-is" and **onsemi** makes no warranty, representation or guarantee regarding the accuracy of the information, product features, availability, functionality, or suitability of its products for any particular purpose, nor does **onsemi** assume any liability arising out of the application or use of any product or circuit, and specifically disclaims any and all liability, including without limitation special, consequential or incidental damages. Buyer is responsible for its products and applications using **onsemi** products, including compliance with all laws, regulations and safety requirements or standards, regardless of any support or applications information provided by **onsemi**. "Typical" parameters which may be provided in **onsemi** data sheets and/or specifications can and do vary in different applications and actual performance may vary over time. All operating parameters, including "Typicals" must be validated for each customer application by customer's technical experts. **onsemi** does not convey any license under any of its intellectual property rights nor the rights of others. **onsemi** products are not designed, intended, or authorized for use as a critical component in life support systems or any FDA Class 3 medical devices or medical devices with a same or similar classification in a foreign jurisdiction or any devices intended for implantation in the human body. Should Buyer purchase or use **onsemi** products for any such unintended or unauthorized application, Buyer shall indemnify and hold **onsemi** and its officers, employees, subsidiaries, affiliates, and distributors harmless against all claims, costs, damages, and expenses, and reasonable attorney fees arising out of, directly or indirectly, any claim of personal injury or death associated with such unintended or unauthorized use, even if such claim alleges that **onsemi** was negligent regarding the design or manufacture of the part. **onsemi** is an Equal Opportunity/Affirmative Action Employer. This literature is subject to all applicable copyright laws and is not for resale in any manner.

## ADDITIONAL INFORMATION

### TECHNICAL PUBLICATIONS:

Technical Library: [www.onsemi.com/design/resources/technical-documentation](http://www.onsemi.com/design/resources/technical-documentation)  
onsemi Website: [www.onsemi.com](http://www.onsemi.com)

### ONLINE SUPPORT: [www.onsemi.com/support](http://www.onsemi.com/support)

For additional information, please contact your local Sales Representative at [www.onsemi.com/support/sales](http://www.onsemi.com/support/sales)