

# MBRM120LT1G, NRVBM120LT1G, MBRM120LT3G, NRVBM120LT3G

## Schottky Power Rectifier, Surface Mount, 1.0 A, 20 V

The Schottky POWERMITE<sup>®</sup> employs the Schottky Barrier principle with a barrier metal and epitaxial construction that produces optimal forward voltage drop–reverse current tradeoff. The advanced packaging techniques provide for a highly efficient micro miniature, space saving surface mount Rectifier. With its unique heatsink design, the POWERMITE<sup>®</sup> has the same thermal performance as the SMA while being 50% smaller in footprint area, and delivering one of the lowest height profiles, < 1.1 mm in the industry. Because of its small size, it is ideal for use in portable and battery powered products such as cellular and cordless phones, chargers, notebook computers, printers, PDAs and PCMCIA cards. Typical applications are AC–DC and DC –DC converters, reverse battery protection, and “ORing” of multiple supply voltages and any other application where performance and size are critical.

### Features

- Low Profile – Maximum Height of 1.1 mm
- Small Footprint – Footprint Area of 8.45 mm<sup>2</sup>
- Low V<sub>F</sub> Provides Higher Efficiency and Extends Battery Life
- Supplied in 12 mm Tape and Reel
- Low Thermal Resistance with Direct Thermal Path of Die on Exposed Cathode Heat Sink
- ESD Ratings:
  - ◆ Human Body Model = 3B (> 16 kV)
  - ◆ Machine Model = C (> 400 V)
- AEC–Q101 Qualified and PPAP Capable
- NRVB Prefix for Automotive and Other Applications Requiring Unique Site and Control Change Requirements
- All Packages are Pb–Free\*

### Mechanical Characteristics:

- POWERMITE<sup>®</sup> is JEDEC Registered as D0–216AA
- Case: Molded Epoxy
- Epoxy Meets UL 94 V–0 @ 0.125 in
- Weight: 16.3 mg (Approximately)
- Lead and Mounting Surface Temperature for Soldering Purposes: 260°C Maximum for 10 Seconds

\*For additional information on our Pb–Free strategy and soldering details, please download the ON Semiconductor Soldering and Mounting Techniques Reference Manual, SOLDERRM/D.



ON Semiconductor<sup>®</sup>

<http://onsemi.com>

## SCHOTTKY BARRIER RECTIFIER 1.0 AMPERES, 20 VOLTS

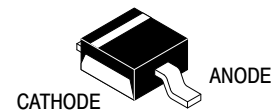

POWERMITE  
CASE 457  
PLASTIC

### MARKING DIAGRAM

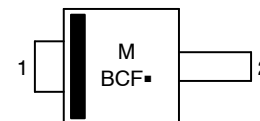

M = Date Code  
BCF = Device Code  
▪ = Pb–Free Package

### ORDERING INFORMATION

Device	Package	Shipping <sup>†</sup>
MBRM120LT1G	POWERMITE (Pb–Free)	3,000 / Tape & Reel
NRVBM120LT1G	POWERMITE (Pb–Free)	3,000 / Tape & Reel
MBRM120LT3G	POWERMITE (Pb–Free)	12,000 / Tape & Reel
NRVBM120LT3G	POWERMITE (Pb–Free)	12,000 / Tape & Reel

<sup>†</sup>For information on tape and reel specifications, including part orientation and tape sizes, please refer to our Tape and Reel Packaging Specifications Brochure, BRD8011/D.

# MBRM120LT1G, NRVBM120LT1G, MBRM120LT3G, NRVBM120LT3G

## MAXIMUM RATINGS

Rating	Symbol	Value	Unit
Peak Repetitive Reverse Voltage Working Peak Reverse Voltage DC Blocking Voltage	$V_{RRM}$ $V_{RWM}$ $V_R$	20	V
Average Rectified Forward Current (At Rated $V_R$ , $T_C = 135^\circ\text{C}$ )	$I_O$	1.0	A
Peak Repetitive Forward Current (At Rated $V_R$ , Square Wave, 100 kHz, $T_C = 135^\circ\text{C}$ )	$I_{FRM}$	2.0	A
Non-Repetitive Peak Surge Current (Non-Repetitive peak surge current, halfwave, single phase, 60 Hz)	$I_{FSM}$	50	A
Storage Temperature	$T_{stg}$	-55 to 150	$^\circ\text{C}$
Operating Junction Temperature	$T_J$	-55 to 125	$^\circ\text{C}$
Voltage Rate of Change (Rated $V_R$ , $T_J = 25^\circ\text{C}$ )	dv/dt	10,000	V/ $\mu\text{s}$

Stresses exceeding Maximum Ratings may damage the device. Maximum Ratings are stress ratings only. Functional operation above the Recommended Operating Conditions is not implied. Extended exposure to stresses above the Recommended Operating Conditions may affect device reliability.

## THERMAL CHARACTERISTICS

Characteristic	Symbol	Value	Unit
Thermal Resistance, Junction-to-Lead (Anode) (Note 1)	$R_{tjl}$	35	$^\circ\text{C}/\text{W}$
Thermal Resistance, Junction-to-Tab (Cathode) (Note 1)	$R_{tjtab}$	23	
Thermal Resistance, Junction-to-Ambient (Note 1)	$R_{tja}$	277	

1. Mounted with minimum recommended pad size, PC Board FR4, See Figures 9 & 10.

## ELECTRICAL CHARACTERISTICS

Characteristic	Symbol	Value		Unit
Maximum Instantaneous Forward Voltage (Note 2), See Figure 2  ( $I_F = 0.1\text{ A}$ ) ( $I_F = 1.0\text{ A}$ ) ( $I_F = 3.0\text{ A}$ )	$V_F$	$T_J = 25^\circ\text{C}$	$T_J = 85^\circ\text{C}$	V
		0.34	0.26	
		0.45	0.415	
Maximum Instantaneous Reverse Current (Note 2), See Figure 4  ( $V_R = 20\text{ V}$ ) ( $V_R = 10\text{ V}$ )	$I_R$	$T_J = 25^\circ\text{C}$	$T_J = 85^\circ\text{C}$	mA
		0.40	25	
		0.10	18	

2. Pulse Test: Pulse Width  $\leq 250\ \mu\text{s}$ , Duty Cycle  $\leq 2\%$ .

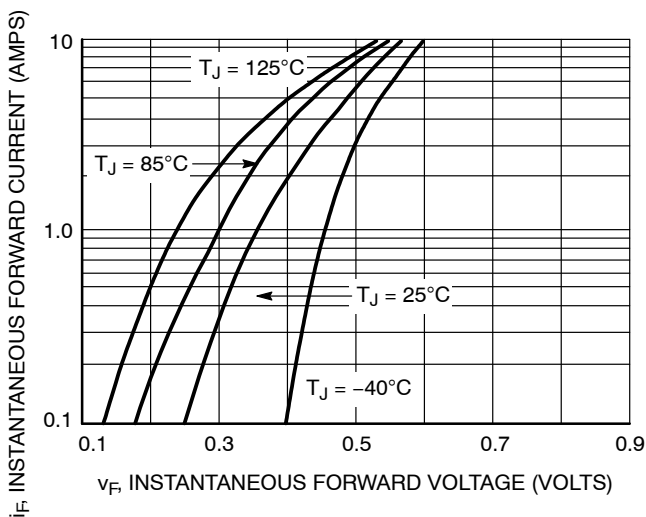

Figure 1. Typical Forward Voltage

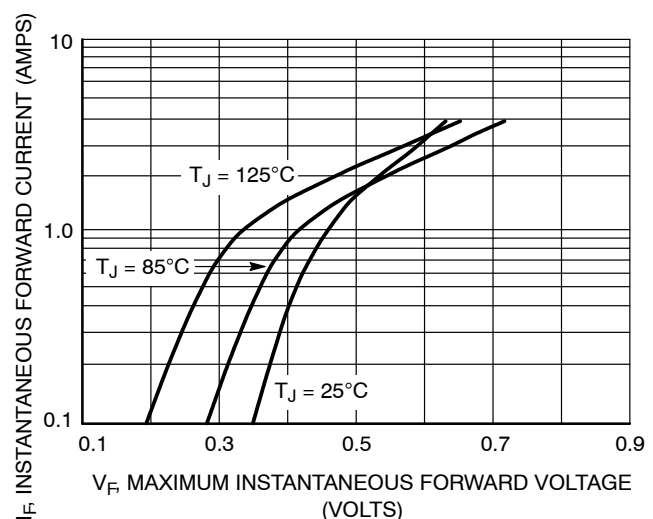

Figure 2. Maximum Forward Voltage

# MBRM120LT1G, NRVBM120LT1G, MBRM120LT3G, NRVBM120LT3G

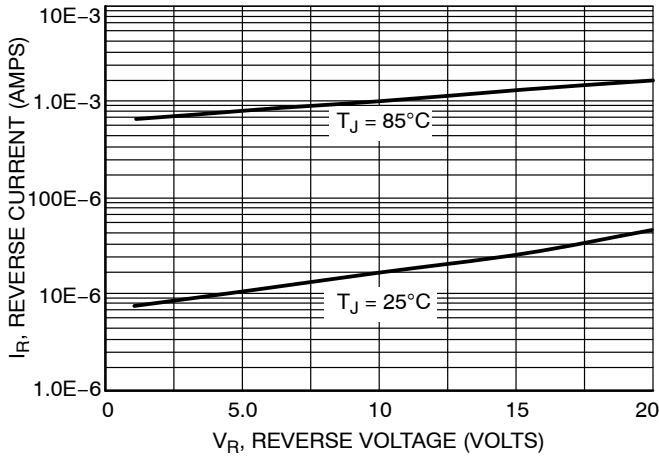

Figure 3. Typical Reverse Current

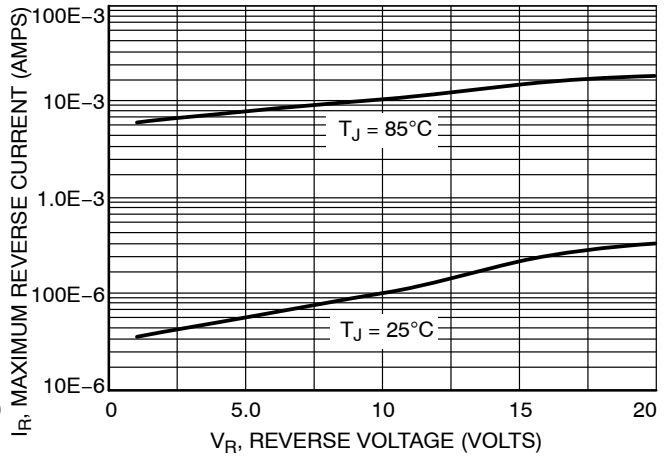

Figure 4. Maximum Reverse Current

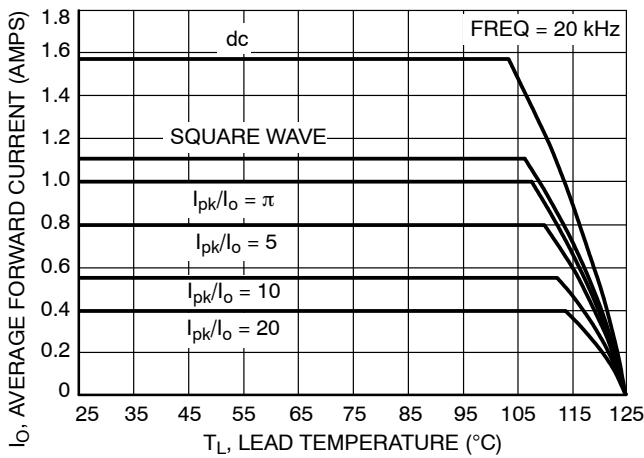

Figure 5. Current Derating

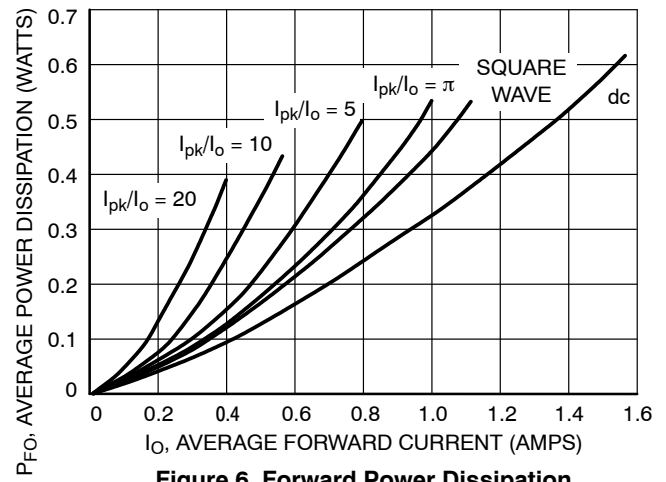

Figure 6. Forward Power Dissipation

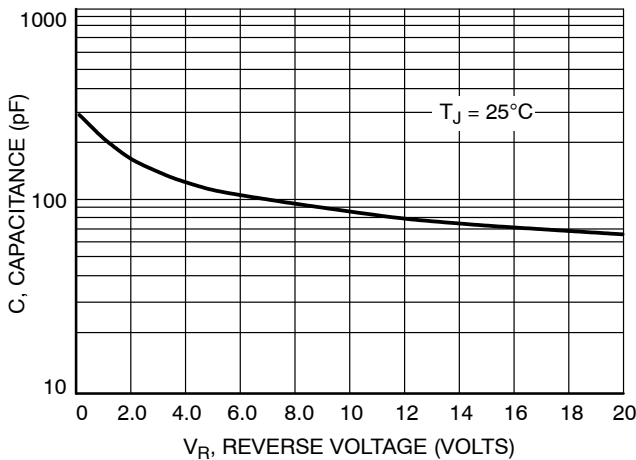

Figure 7. Capacitance

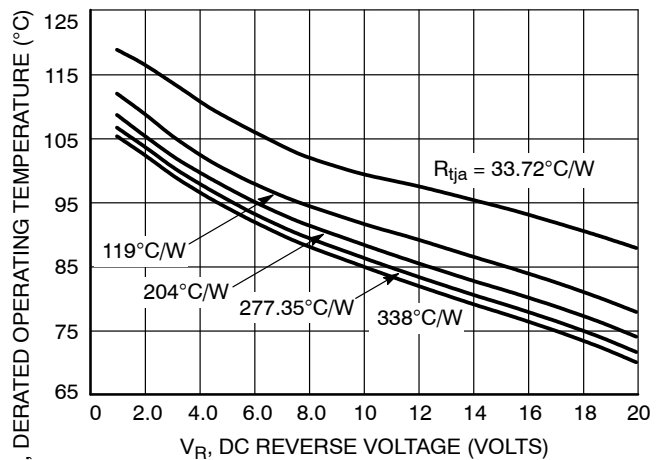

Figure 8. Typical Operating Temperature Derating\*

\* Reverse power dissipation and the possibility of thermal runaway must be considered when operating this device under any reverse voltage conditions. Calculations of  $T_J$  therefore must include forward and reverse power effects. The allowable operating  $T_J$  may be calculated from the equation:

$$T_J = T_{Jmax} - r(t)(P_f + P_r) \text{ where}$$

$r(t)$  = thermal impedance under given conditions,  
 $P_f$  = forward power dissipation, and  
 $P_r$  = reverse power dissipation

This graph displays the derated allowable  $T_J$  due to reverse bias under DC conditions only and is calculated as  $T_J = T_{Jmax} - r(t)P_r$ , where  $r(t) = R_{thja}$ . For other power applications further calculations must be performed.

**MBRM120LT1G, NRVBM120LT1G, MBRM120LT3G, NRVBM120LT3G**

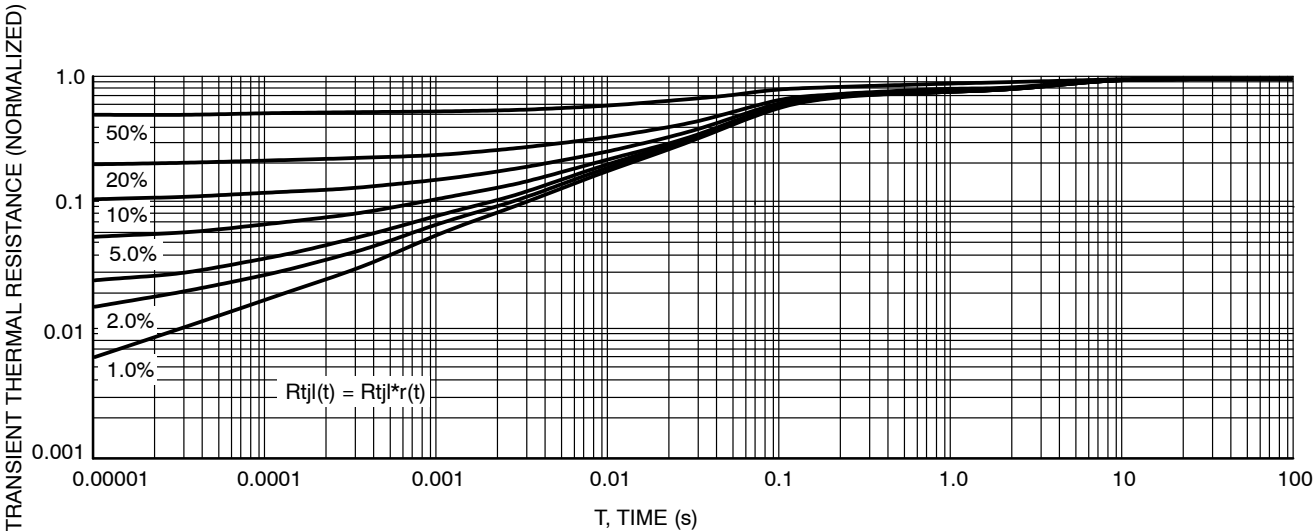

**Figure 9. Thermal Response Junction to Lead**

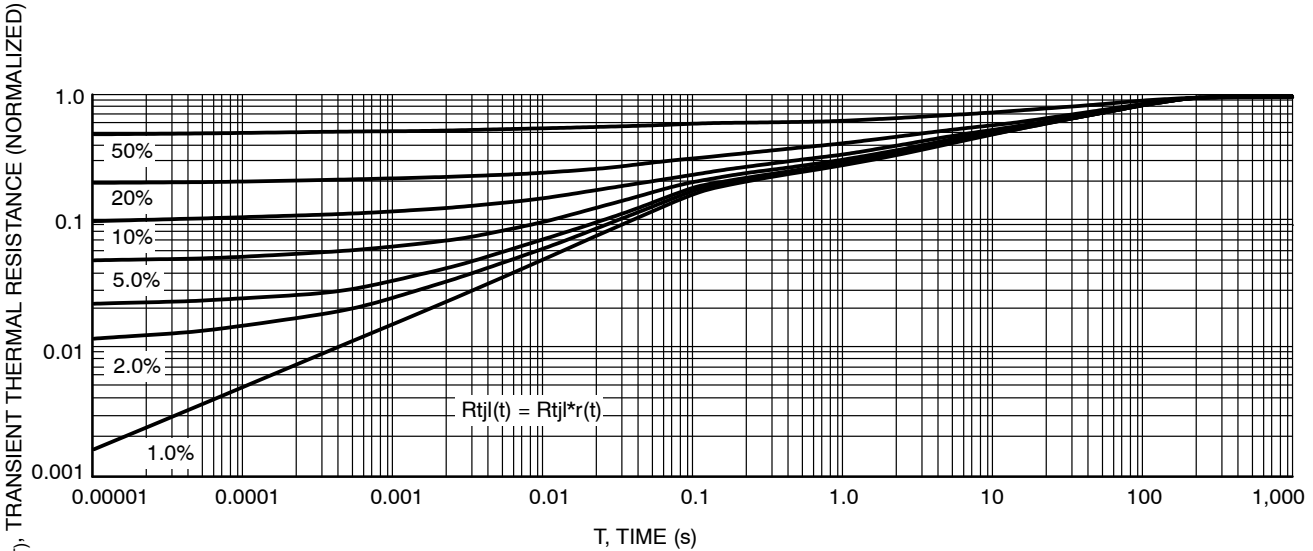

**Figure 10. Thermal Response Junction to Ambient**

POWERMITE is a registered trademark of and used under a license from Microsemi Corporation.

# MECHANICAL CASE OUTLINE PACKAGE DIMENSIONS



SCALE 4:1

## POWERMITE CASE 457 ISSUE G

DATE 12 JAN 2022



RECOMMENDED  
MOUNTING FOOTPRINT

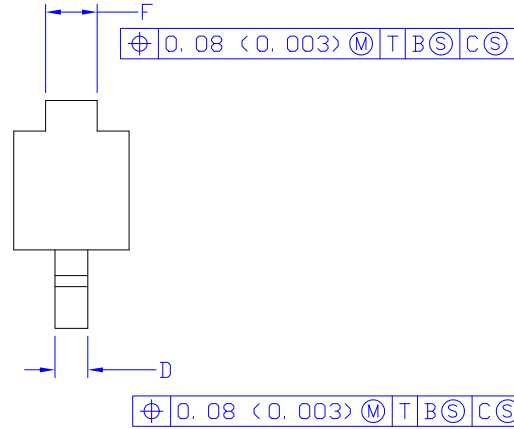

DIM	MILLIMETERS		INCHES	
	MIN.	MAX.	MIN.	MAX.
A	1.75	2.05	0.069	0.081
B	1.75	2.18	0.069	0.086
C	0.85	1.15	0.033	0.045
D	0.40	0.69	0.016	0.027
F	0.70	1.00	0.028	0.039
H	-0.05	0.10	-0.002	0.004
J	0.10	0.25	0.004	0.010
K	3.60	3.90	0.142	0.154
L	0.50	0.80	0.020	0.031
R	1.20	1.50	0.047	0.059
S	0.50 REF		0.019 REF	

NOTES:

1. DIMENSIONING AND TOLERANCING PER ASME Y14.5M, 1994.
2. CONTROLLING DIMENSION: MILLIMETERS
3. DIMENSION b APPLIES TO PLATED TERMINAL AND IS MEASURED BETWEEN 0.15 AND 0.30mm FROM THE TERMINAL TIP.

GENERIC  
MARKING DIAGRAMS\*

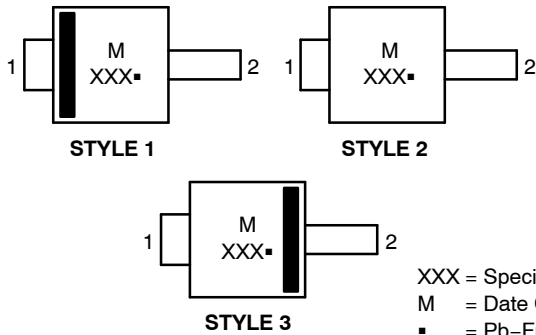

- |  |  |  |
|--|--|--|
| STYLE 1:<br>PIN 1. CATHODE<br>2. ANODE | STYLE 2:<br>PIN 1. ANODE OR CATHODE<br>2. CATHODE OR ANODE<br>(BI-DIRECTIONAL) | STYLE 3:<br>PIN 1. ANODE<br>2. CATHODE |
|--|--|--|

\*This information is generic. Please refer to device data sheet for actual part marking. Pb-Free indicator, "G" or microdot "▪", may or may not be present. Some products may not follow the Generic Marking.

DOCUMENT NUMBER:	98ASB14853C	Electronic versions are uncontrolled except when accessed directly from the Document Repository. Printed versions are uncontrolled except when stamped "CONTROLLED COPY" in red.
DESCRIPTION:	POWERMITE	PAGE 1 OF 1

onsemi and ONSEMI are trademarks of Semiconductor Components Industries, LLC dba onsemi or its subsidiaries in the United States and/or other countries. onsemi reserves the right to make changes without further notice to any products herein. onsemi makes no warranty, representation or guarantee regarding the suitability of its products for any particular purpose, nor does onsemi assume any liability arising out of the application or use of any product or circuit, and specifically disclaims any and all liability, including without limitation special, consequential or incidental damages. onsemi does not convey any license under its patent rights nor the rights of others.

**onsemi**, **Onsemi**, and other names, marks, and brands are registered and/or common law trademarks of Semiconductor Components Industries, LLC dba "**onsemi**" or its affiliates and/or subsidiaries in the United States and/or other countries. **onsemi** owns the rights to a number of patents, trademarks, copyrights, trade secrets, and other intellectual property. A listing of **onsemi**'s product/patent coverage may be accessed at [www.onsemi.com/site/pdf/Patent-Marking.pdf](http://www.onsemi.com/site/pdf/Patent-Marking.pdf). **onsemi** reserves the right to make changes at any time to any products or information herein, without notice. The information herein is provided "as-is" and **onsemi** makes no warranty, representation or guarantee regarding the accuracy of the information, product features, availability, functionality, or suitability of its products for any particular purpose, nor does **onsemi** assume any liability arising out of the application or use of any product or circuit, and specifically disclaims any and all liability, including without limitation special, consequential or incidental damages. Buyer is responsible for its products and applications using **onsemi** products, including compliance with all laws, regulations and safety requirements or standards, regardless of any support or applications information provided by **onsemi**. "Typical" parameters which may be provided in **onsemi** data sheets and/or specifications can and do vary in different applications and actual performance may vary over time. All operating parameters, including "Typicals" must be validated for each customer application by customer's technical experts. **onsemi** does not convey any license under any of its intellectual property rights nor the rights of others. **onsemi** products are not designed, intended, or authorized for use as a critical component in life support systems or any FDA Class 3 medical devices or medical devices with a same or similar classification in a foreign jurisdiction or any devices intended for implantation in the human body. Should Buyer purchase or use **onsemi** products for any such unintended or unauthorized application, Buyer shall indemnify and hold **onsemi** and its officers, employees, subsidiaries, affiliates, and distributors harmless against all claims, costs, damages, and expenses, and reasonable attorney fees arising out of, directly or indirectly, any claim of personal injury or death associated with such unintended or unauthorized use, even if such claim alleges that **onsemi** was negligent regarding the design or manufacture of the part. **onsemi** is an Equal Opportunity/Affirmative Action Employer. This literature is subject to all applicable copyright laws and is not for resale in any manner.

## ADDITIONAL INFORMATION

### TECHNICAL PUBLICATIONS:

Technical Library: [www.onsemi.com/design/resources/technical-documentation](http://www.onsemi.com/design/resources/technical-documentation)  
onsemi Website: [www.onsemi.com](http://www.onsemi.com)

### ONLINE SUPPORT: [www.onsemi.com/support](http://www.onsemi.com/support)

For additional information, please contact your local Sales Representative at [www.onsemi.com/support/sales](http://www.onsemi.com/support/sales)