

# 3.3 V ECL 8-Bit Synchronous Binary Up Counter

## MC100EP016A

### Description

The MC100EP016A is a high-speed synchronous, presettable, cascadeable 8-bit binary counter. Architecture and operation are the same as the ECLinPS™ family MC100E016 with higher operating speed.

The counter features internal feedback to  $\overline{TC}$  gated by the TCLD (Terminal Count Load) pin. When TCLD is LOW (or left open, in which case it is pulled LOW by the internal pulldowns), the  $\overline{TC}$  feedback is disabled, and counting proceeds continuously, with  $\overline{TC}$  going LOW to indicate an all-one state. When TCLD is HIGH, the TC feedback causes the counter to automatically reload upon  $TC = LOW$ , thus functioning as a programmable counter. The Qn outputs do not need to be terminated for the count function to operate properly. To minimize noise and power, unused Q outputs should be left unterminated.

CO $\overline{UT}$  and  $\overline{COUT}$  provide differential outputs from a single, non-cascaded counter or divider application. CO $\overline{UT}$  and  $\overline{COUT}$  should not be used in cascade configuration. Only  $\overline{TC}$  should be used for a counter or divider cascade chain output.

A differential clock input has also been added to improve performance.

The 100 Series contains temperature compensation.

### Features

- 550 ps Typical Propagation Delay
- Operation Frequency > 1.3 GHz is 30% Faster than MC100EP016
- PECL Mode Operating Range:  $V_{CC} = 3.0\text{ V to }3.6\text{ V}$  with  $V_{EE} = 0\text{ V}$
- NECL Mode Operating Range:  $V_{CC} = 0\text{ V}$  with  $V_{EE} = -3.0\text{ V to }-3.6\text{ V}$
- Open Input Default State
- Safety Clamp on Clock Inputs
- Internal  $\overline{TC}$  Feedback (Gated)
- Addition of CO $\overline{UT}$  and  $\overline{COUT}$
- 8-Bit
- Differential Clock Input
- $V_{BB}$  Output
- Fully Synchronous Counting and  $\overline{TC}$  Generation
- Asynchronous Master Reset
- Pb-Free Packages are Available

### MARKING DIAGRAMS\*

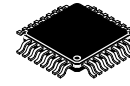

LQFP-32, 7x7  
CASE 561AB

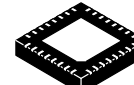
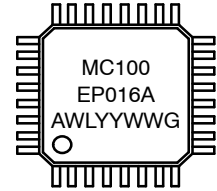

QFN32  
MN SUFFIX  
CASE 488AM

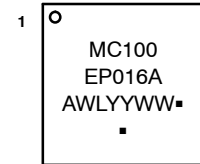

- A = Assembly Location
  - WL = Wafer Lot
  - YY = Year
  - WW = Work Week
  - G or ■ = Pb-Free Package
- (Note: Microdot may be in either location)

\*For additional marking information, refer to Application Note AND8002/D.

### ORDERING INFORMATION

See detailed ordering and shipping information in the package dimensions section on page 11 of this data sheet.

# MC100EP016A

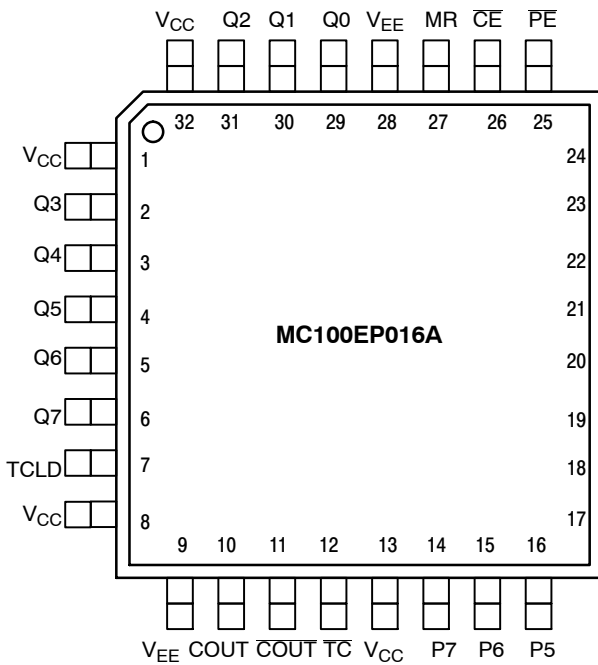

Warning: All  $V_{CC}$  and  $V_{EE}$  pins must be externally connected to Power Supply to guarantee proper operation.

Figure 1. 32-Lead LQFP Pinout (Top View)

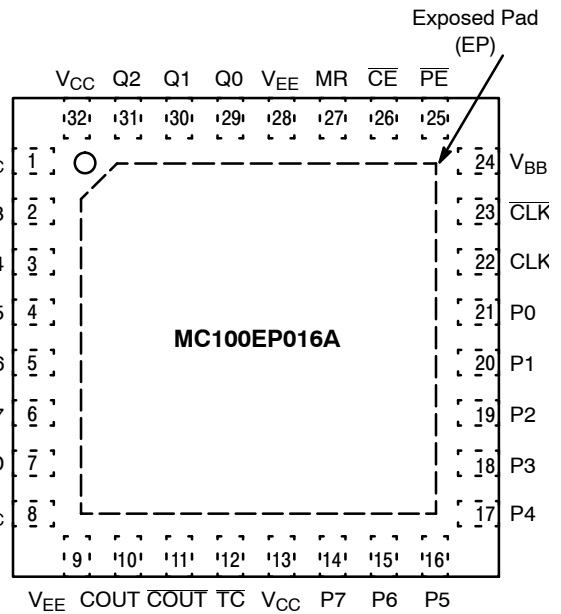

Figure 2. 32-Lead QFN Pinout (Top View)

Table 1. PIN DESCRIPTION

Pin	Function
P0–P7	ECL Parallel Data (Preset) Inputs
Q0–Q7	ECL Data Outputs
$\overline{CE}^*$	ECL Count Enable Control Input
$\overline{PE}^*$	ECL Parallel Load Enable Control Input
$\overline{MR}^*$	ECL Master Reset
$\overline{CLK}^*$ , $\overline{CLK}^*$	ECL Differential Clock
$\overline{TC}$	ECL Terminal Count Output
$\overline{TCLD}^*$	ECL TC–Load Control Input
$\overline{COUT}$ , $\overline{COUT}$	ECL Differential Output
$V_{CC}$	Positive Supply
$V_{EE}$	Negative Supply
$V_{BB}$	Reference Voltage Output
EP	The exposed pad (EP) on the QFN–32 package bottom is thermally connected to the die for improved heat–sinking conduit. The pad is electrically connected to $V_{EE}$ .

\*Pins will default LOW when left open.

# MC100EP016A

**Table 2. FUNCTION TABLE**

CE	PE	TCLD	MR	CLK	FUNCTION
X	L	X	L	Z	Load Parallel (Pn to Qn)
L	H	L	L	Z	Continuous Count
L	H	H	L	Z	Count; Load Parallel on $\overline{TC}$ = LOW
H	H	X	L	Z	Hold
X	X	X	L	ZZ	Masters Respond, Slaves Hold
X	X	X	H	X	Reset (Qn := LOW, $\overline{TC}$ := HIGH)

ZZ = Clock Pulse (High-to-Low)  
 Z = Clock Pulse (Low-to-High)

**Table 3. FUNCTION TABLE**

Function	PE	CE	MR	TCLD	CLK	P7-P4	P3	P2	P1	P0	Q7-Q4	Q3	Q2	Q1	Q0	$\overline{TC}$	$\overline{COUT}$	COUT
Load Count	L	X	L	X	Z	H	H	H	L	L	H	H	H	L	L	H	H	L
	H	L	L	L	Z	X	X	X	X	X	H	H	H	L	H	H	H	L
	H	L	L	L	Z	X	X	X	X	X	H	H	H	H	L	H	H	L
	H	L	L	L	Z	X	X	X	X	X	H	H	H	H	H	L	L	H
	H	L	L	L	Z	X	X	X	X	X	L	L	L	L	L	H	H	L
Load Hold	L	X	L	X	Z	H	H	H	L	L	H	H	H	L	L	H	H	L
	H	H	L	X	Z	X	X	X	X	X	H	H	H	L	L	H	H	L
	H	H	L	X	Z	X	X	X	X	X	H	H	H	L	L	H	H	L
Load on Terminal Count	H	L	L	H	Z	H	L	H	H	L	H	H	H	L	H	H	H	L
	H	L	L	H	Z	H	L	H	H	L	H	H	H	H	L	H	H	L
	H	L	L	H	Z	H	L	H	H	L	H	H	H	H	L	L	L	H
	H	L	L	H	Z	H	L	H	H	L	H	L	H	H	L	H	H	L
	H	L	L	H	Z	H	L	H	H	L	H	L	H	H	H	H	H	L
Reset	X	X	H	X	X	X	X	X	X	X	L	L	L	L	L	H	H	L



# MC100EP016A

**Table 4. ATTRIBUTES**

Characteristics	Value	
Internal Input Pulldown Resistor	75 kΩ	
Internal Input Pullup Resistor	N/A	
ESD Protection	Human Body Model	> 2 kV
	Machine Model	> 100 V
	Charged Device Model	> 2 kV
Moisture Sensitivity, Indefinite Time Out of Drypack (Note 1)	Pb Pkg	Pb-Free Pkg
	LQFP-32	Level 2
	QFN-32	Level 2 Level 1
Flammability Rating Oxygen Index: 28 to 34	UL 94 V-0 @ 0.125 in	
Transistor Count	1226 Devices	
Meets or exceeds JEDEC Spec EIA/JESD78 IC Latchup Test		

1. For additional information, see Application Note AND8003/D.

**Table 5. MAXIMUM RATINGS**

Symbol	Parameter	Condition 1	Condition 2	Rating	Unit
V <sub>CC</sub>	PECL Mode Power Supply	V <sub>EE</sub> = 0 V		6	V
V <sub>EE</sub>	NECL Mode Power Supply	V <sub>CC</sub> = 0 V		-6	V
V <sub>I</sub>	PECL Mode Input Voltage	V <sub>EE</sub> = 0 V	V <sub>I</sub> ≤ V <sub>CC</sub>	6	V
	NECL Mode Input Voltage	V <sub>CC</sub> = 0 V	V <sub>I</sub> ≥ V <sub>EE</sub>	-6	V
I <sub>out</sub>	Output Current	Continuous		50	mA
		Surge		100	mA
I <sub>BB</sub>	V <sub>BB</sub> Sink/Source			± 0.5	mA
T <sub>A</sub>	Operating Temperature Range			-40 to +70	°C
T <sub>stg</sub>	Storage Temperature Range			-65 to +150	°C
θ <sub>JA</sub>	Thermal Resistance (Junction-to-Ambient)	0 lfpm	32 LQFP	74	°C/W
		500 lfpm	32 LQFP	61	°C/W
θ <sub>JC</sub>	Thermal Resistance (Junction-to-Case)	Standard Board	32 LQFP	12 to 17	°C/W
θ <sub>JA</sub>	Thermal Resistance (Junction-to-Ambient)	0 lfpm	QFN-32	31	°C/W
		500 lfpm	QFN-32	27	°C/W
θ <sub>JC</sub>	Thermal Resistance (Junction-to-Case)	2S2P	QFN-32	12	°C/W
T <sub>sol</sub>	Wave Solder	Pb		265	°C
		Pb-Free		265	°C

Stresses exceeding Maximum Ratings may damage the device. Maximum Ratings are stress ratings only. Functional operation above the Recommended Operating Conditions is not implied. Extended exposure to stresses above the Recommended Operating Conditions may affect device reliability.

# MC100EP016A

**Table 6. 100EP DC CHARACTERISTICS, PECL**  $V_{CC} = 3.3\text{ V}$ ,  $V_{EE} = 0\text{ V}$  (Note 2)

Symbol	Characteristic	-40°C			25°C			70°C			Unit
		Min	Typ	Max	Min	Typ	Max	Min	Typ	Max	
$I_{EE}$	Power Supply Current	130	170	210	130	177	210	130	180	210	mA
$V_{OH}$	Output HIGH Voltage (Note 3)	2155	2280	2405	2155	2280	2405	2155	2280	2405	mV
$V_{OL}$	Output LOW Voltage (Note 3)	1355	1480	1605	1355	1480	1605	1355	1480	1605	mV
$V_{IH}$	Input HIGH Voltage (Single-Ended)	2075		2420	2075		2420	2075		2420	mV
$V_{IL}$	Input LOW Voltage (Single-Ended)	1355		1675	1355		1675	1355		1675	mV
$V_{BB}$	Output Voltage Reference	1775	1875	1975	1775	1875	1975	1775	1875	1975	mV
$V_{IHCMR}$	Input HIGH Voltage Common Mode Range (Differential Configuration) (Note 4)	2.0		3.3	2.0		3.3	2.0		3.3	V
$I_{IH}$	Input HIGH Current			150			150			150	$\mu\text{A}$
$I_{IL}$	Input LOW Current	0.5			0.5			0.5			$\mu\text{A}$

NOTE: Device will meet the specifications after thermal equilibrium has been established when mounted in a test socket or printed circuit board with maintained transverse airflow greater than 500 lfm. Electrical parameters are guaranteed only over the declared operating temperature range. Functional operation of the device exceeding these conditions is not implied. Device specification limit values are applied individually under normal operating conditions and not valid simultaneously.

2. Input and output parameters vary 1:1 with  $V_{CC}$ .  $V_{EE}$  can vary +0.3 V to -0.3 V.

3. All loading with 50 ohms to  $V_{CC}$ -2.0 volts.

4.  $V_{IHCMR}$  min varies 1:1 with  $V_{EE}$ .  $V_{IHCMR}$  max varies 1:1 with  $V_{CC}$ . The  $V_{IHCMR}$  range is referenced to the most positive side of the differential input signal.

**Table 7. 100EP DC CHARACTERISTICS, NECL**  $V_{CC} = 0\text{ V}$ ,  $V_{EE} = -3.6\text{ V}$  to  $-3.0\text{ V}$  (Note 5)

Symbol	Characteristic	-40°C			25°C			70°C			Unit
		Min	Typ	Max	Min	Typ	Max	Min	Typ	Max	
$I_{EE}$	Power Supply Current	130	170	210	130	177	210	130	180	210	mA
$V_{OH}$	Output HIGH Voltage (Note 6)	-1145	-1020	-895	-1145	-1020	-895	-1145	-1020	-895	mV
$V_{OL}$	Output LOW Voltage (Note 6)	-1945	-1820	-1695	-1945	-1820	-1695	-1945	-1820	-1695	mV
$V_{IH}$	Input HIGH Voltage (Single-Ended)	-1225		-880	-1225		-880	-1225		-880	mV
$V_{IL}$	Input LOW Voltage (Single-Ended)	-1945		-1625	-1945		-1625	-1945		-1625	mV
$V_{BB}$	Output Voltage Reference	-1525	-1425	-1325	-1525	-1425	-1325	-1525	-1425	-1325	mV
$V_{IHCMR}$	Input HIGH Voltage Common Mode Range (Differential Configuration) (Note 7)	$V_{EE}+2.0$		0.0	$V_{EE}+2.0$		0.0	$V_{EE}+2.0$		0.0	V
$I_{IH}$	Input HIGH Current			150			150			150	$\mu\text{A}$
$I_{IL}$	Input LOW Current	0.5			0.5			0.5			$\mu\text{A}$

NOTE: Device will meet the specifications after thermal equilibrium has been established when mounted in a test socket or printed circuit board with maintained transverse airflow greater than 500 lfm. Electrical parameters are guaranteed only over the declared operating temperature range. Functional operation of the device exceeding these conditions is not implied. Device specification limit values are applied individually under normal operating conditions and not valid simultaneously.

5. Input and output parameters vary 1:1 with  $V_{CC}$ .

6. All loading with 50 ohms to  $V_{CC}$ -2.0 volts.

7.  $V_{IHCMR}$  min varies 1:1 with  $V_{EE}$ .  $V_{IHCMR}$  max varies 1:1 with  $V_{CC}$ . The  $V_{IHCMR}$  range is referenced to the most positive side of the differential input signal.

# MC100EP016A

**Table 8. AC CHARACTERISTICS**  $V_{EE} = -3.0\text{ V to }-3.6\text{ V}$ ;  $V_{CC} = 0\text{ V or }3.0\text{ V to }3.6\text{ V}$ ;  $V_{EE} = 0\text{ V}$  (Note 8)

Symbol	Characteristic	-40°C			25°C			70°C			Unit
		Min	Typ	Max	Min	Typ	Max	Min	Typ	Max	
f <sub>COUNT</sub>	Maximum Frequency Count & Division Modes Q, $\overline{TC}$ , COUT/ $\overline{COUT}$	1.3	1.5		1.2	1.4		1.2	1.3		GHz
t <sub>PLH</sub> t <sub>PHL</sub>	Propagation Delay CLK to Q MR to Q CLK to $\overline{TC}$ MR to $\overline{TC}$ CLK to COUT/ $\overline{COUT}$ MR to COUT/ $\overline{COUT}$	350 400 350 400 475 450	511 550 511 555 705 720	650 700 650 700 850 850	400 400 400 400 500 500	550 570 550 570 745 760	700 750 700 750 900 900	480 450 480 520 550 570	610 630 610 635 825 830	780 820 780 820 1000 950	ps
t <sub>S</sub>	Setup Time P0 P1 to P4 P5 to P7 $\overline{CE}$ $\overline{PE}$ TCLD	400 300 250 500 500 550	240 140 80 320 315 355		400 300 250 500 500 550	240 135 65 330 320 365		400 300 250 500 500 550	245 125 55 340 325 380		ps
t <sub>H</sub>	Hold Time P0 P1 to P4 P5 to P7 $\overline{CE}$ $\overline{PE}$ TCLD	100 50 150 600 625 525	-145 -160 -105 380 465 320		100 50 150 600 625 525	-155 -170 -110 410 500 325		100 50 150 600 625 525	-170 -180 -115 450 535 340		ps
t <sub>JITTER</sub>	Clock Random Jitter (RMS, 1000 Waveforms)		2.6	8.5		2.5	8.0		2.5	8.0	ps
t <sub>RR</sub>	Reset Recovery Time	400	195		400	205		400	220		ps
t <sub>PW</sub>	Minimum Pulse Width CLK Minimum Pulse Width MR	385 550	334 380		416 550	357 380		416 550	385 380		ps
t <sub>r</sub> , t <sub>f</sub>	Output Rise/Fall Times 20% – 80%	90	180	320	100	190	320	125	215	450	ps

NOTE: Device will meet the specifications after thermal equilibrium has been established when mounted in a test socket or printed circuit board with maintained transverse airflow greater than 500 lfpm. Electrical parameters are guaranteed only over the declared operating temperature range. Functional operation of the device exceeding these conditions is not implied. Device specification limit values are applied individually under normal operating conditions and not valid simultaneously.

8. Measured using a 750 mV source, 50% duty cycle clock source. All loading with 50 ohms to  $V_{CC}-2.0\text{ V}$ .

APPLICATIONS INFORMATION

**Cascading Multiple EP016A Devices**

For applications which call for larger than 8-bit counters multiple EP016As can be tied together to achieve very wide bit width counters. The active low terminal count ( $\overline{TC}$ ) output and count enable input ( $\overline{CE}$ ) greatly facilitate the cascading of EP016A devices. Two EP016As can be cascaded without the need for external gating, however for counters wider than 16 bits external OR gates are necessary for cascade implementations.

Figure 4 below pictorially illustrates the cascading of 4 EP016As to build a 32-bit high frequency counter. Note the EP01 gates used to OR the terminal count outputs of the lower order EP016As to control the counting operation of the higher order bits. When the terminal count of the preceding device (or devices) goes low (the counter reaches an all 1s state) the more significant EP016A is set in its count mode and will count one binary digit upon the next positive clock transition. In addition, the preceding devices will also

count one bit thus sending their terminal count outputs back to a high state disabling the count operation of the more significant counters and placing them back into hold modes. Therefore, for an EP016A in the chain to count, all of the lower order terminal count outputs must be in the low state. The bit width of the counter can be increased or decreased by simply adding or subtracting EP016A devices from Figure 4 and maintaining the logic pattern illustrated in the same figure.

The maximum frequency of operation for a cascaded counter chain is set by the propagation delay of the  $\overline{TC}$  output, the necessary setup time of the  $\overline{CE}$  input, and the propagation delay through the OR gate controlling it (for 16-bit counters the limitation is only the  $\overline{TC}$  propagation delay and the  $\overline{CE}$  setup time). Figure 4 shows EP01 gates used to control the count enable inputs, however, if the frequency of operation is slow enough, a LVECL OR gate can be used. Using the worst case guarantees for these parameters.

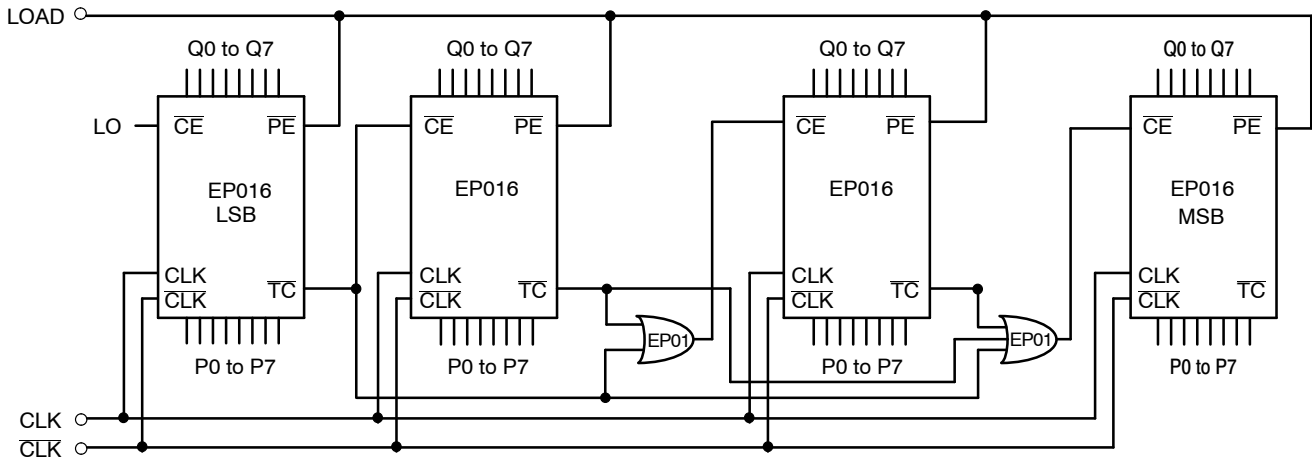

Figure 4. 32-Bit Cascaded EP016A Counter

Note that this assumes the trace delay between the  $\overline{TC}$  outputs and the  $\overline{CE}$  inputs are negligible. If this is not the case estimates of these delays need to be added to the calculations.

**Programmable Divider**

The EP016A has been designed with a control pin which makes it ideal for use as an 8-bit programmable divider. The TCLD pin (load on terminal count) when asserted reloads the

data present at the parallel input pin (Pn's) upon reaching terminal count (an all 1s state on the outputs). Because this feedback is built internal to the chip, the programmable division operation will run at very nearly the same frequency as the maximum counting frequency of the device. Figure 5 below illustrates the input conditions necessary for utilizing the EP016A as a programmable divider set up to divide by 113.



APPLICATIONS INFORMATION (continued)

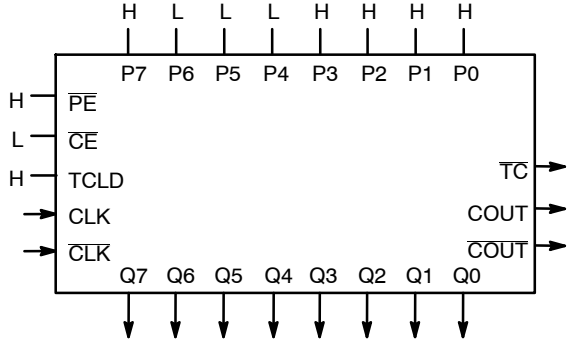

Figure 5. Mod 2 to 256 Programmable Divider

To determine what value to load into the device to accomplish the desired division, the designer simply subtracts the binary equivalent of the desired divide ratio from the binary value for 256. As an example for a divide ratio of 113:

$$P_n's = 256 - 113 = 8F_{16} = 1000\ 1111$$

where:

$$P_0 = \text{LSB and } P_7 = \text{MSB}$$

Forcing this input condition as per the setup in Figure 5 will result in the waveforms of Figure 6. Note that the  $\overline{TC}$  output is used as the divide output and the pulse duration is equal to a full clock period. For even divide ratios, twice the desired divide ratio can be loaded into the EP016A and the  $\overline{TC}$  output can feed the clock input of a toggle flip flop to create a signal divided as desired with a 50% duty cycle.

Table 9. Preset Values for Various Divide Ratios

Divide Ratio	Preset Data Inputs							
	P7	P6	P5	P4	P3	P2	P1	P0
2	H	H	H	H	H	H	H	L
3	H	H	H	H	H	H	L	H
4	H	H	H	H	H	H	L	L
5	H	H	H	H	H	L	H	H
•	•	•	•	•	•	•	•	•
•	•	•	•	•	•	•	•	•
112	H	L	L	H	L	L	L	L
113	H	L	L	L	H	H	H	H
114	H	L	L	L	H	H	H	L
•	•	•	•	•	•	•	•	•
•	•	•	•	•	•	•	•	•
254	L	L	L	L	L	L	H	L
255	L	L	L	L	L	L	L	H
256	L	L	L	L	L	L	L	L

A single EP016A can be used to divide by any ratio from 2 to 256 inclusive. If divide ratios of greater than 256 are needed multiple EP016As can be cascaded in a manner similar to that already discussed. When EP016As are cascaded to build larger dividers the TCLD pin will no longer provide a means for loading on terminal count. Because one does not want to reload the counters until all of the devices in the chain have reached terminal count, external gating of the  $\overline{TC}$  pins must be used for multiple EP016A divider chains.

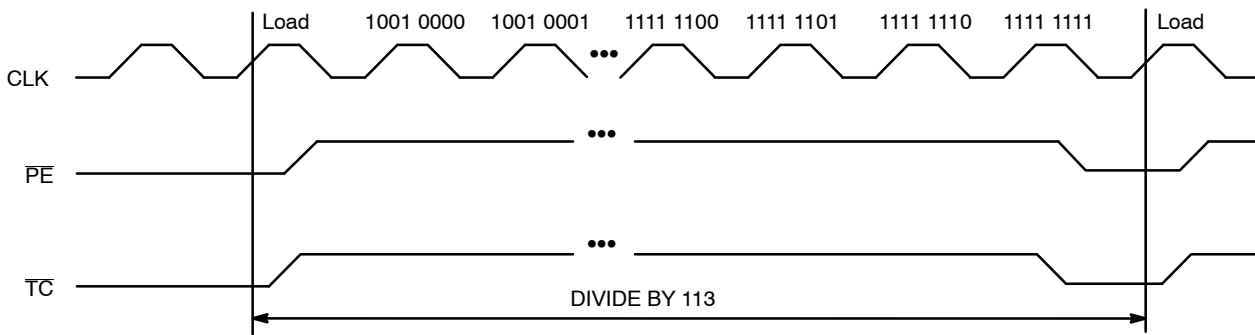

Figure 6. Divide by 113 EP016A Programmable Divider Waveforms



# MC100EP016A

## ORDERING INFORMATION

Device	Package	Shipping†
MC100EP016AFAG	LQFP-32 (Pb-Free)	250 Units / Tray
MC100EP016AMNG	QFN-32 (Pb-Free)	74 Units / Rail
MC100EP016AMNR4G	QFN-32 (Pb-Free)	1000 / Tape & Reel

†For information on tape and reel specifications, including part orientation and tape sizes, please refer to our Tape and Reel Packaging Specifications Brochure, BRD8011/D.

### Resource Reference of Application Notes

- AN1405/D** – ECL Clock Distribution Techniques
- AN1406/D** – Designing with PECL (ECL at +5.0 V)
- AN1503/D** – ECLinPS™ I/O SPiCE Modeling Kit
- AN1504/D** – Metastability and the ECLinPS Family
- AN1568/D** – Interfacing Between LVDS and ECL
- AN1672/D** – The ECL Translator Guide
- AND8001/D** – Odd Number Counters Design
- AND8002/D** – Marking and Date Codes
- AND8020/D** – Termination of ECL Logic Devices
- AND8066/D** – Interfacing with ECLinPS
- AND8090/D** – AC Characteristics of ECL Devices

ECLinPS is a trademark of Semiconductor Components Industries, LLC dba "onsemi" or its affiliates and/or subsidiaries in the United States and/or other countries.

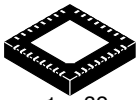

1 32  
SCALE 2:1

QFN32 5x5, 0.5P  
CASE 488AM  
ISSUE A

DATE 23 OCT 2013

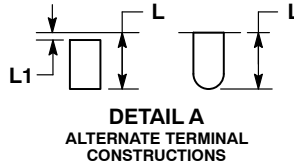
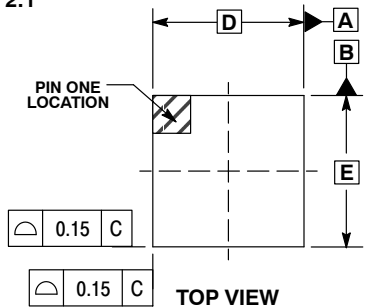

- NOTES:
1. DIMENSIONS AND TOLERANCING PER ASME Y14.5M, 1994.
  2. CONTROLLING DIMENSION: MILLIMETERS.
  3. DIMENSION b APPLIES TO PLATED TERMINAL AND IS MEASURED BETWEEN 0.15 AND 0.30MM FROM THE TERMINAL TIP.
  4. COPLANARITY APPLIES TO THE EXPOSED PAD AS WELL AS THE TERMINALS.

MILLIMETERS		
DIM	MIN	MAX
A	0.80	1.00
A1	---	0.05
A3	0.20	REF
b	0.18	0.30
D	5.00	BSC
D2	2.95	3.25
E	5.00	BSC
E2	2.95	3.25
e	0.50	BSC
K	0.20	---
L	0.30	0.50
L1	---	0.15

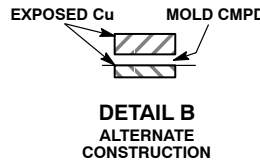
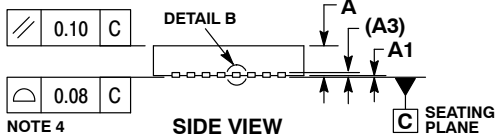

GENERIC  
MARKING DIAGRAM\*

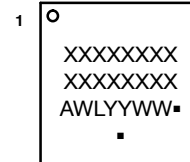
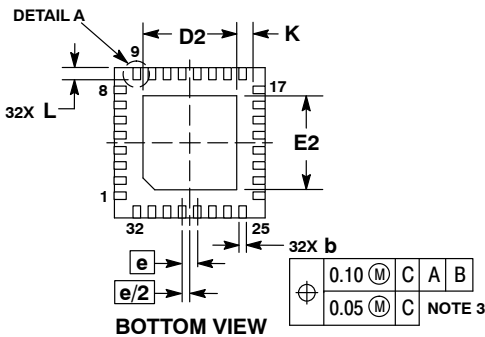

- XXXXX = Specific Device Code
- A = Assembly Location
- WL = Wafer Lot
- YY = Year
- WW = Work Week
- = Pb-Free Package

(Note: Microdot may be in either location)  
\*This information is generic. Please refer to device data sheet for actual part marking.  
Pb-Free indicator, "G" or microdot "▪", may or may not be present.

RECOMMENDED  
SOLDERING FOOTPRINT\*

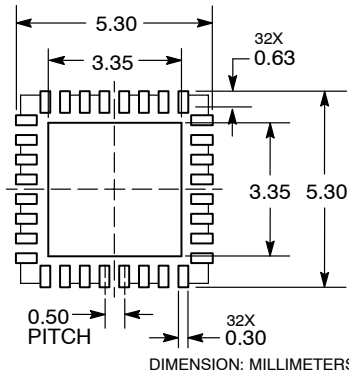

\*For additional information on our Pb-Free strategy and soldering details, please download the ON Semiconductor Soldering and Mounting Techniques Reference Manual, SOLDERRM/D.

DOCUMENT NUMBER:	98AON20032D	Electronic versions are uncontrolled except when accessed directly from the Document Repository. Printed versions are uncontrolled except when stamped "CONTROLLED COPY" in red.
DESCRIPTION:	QFN32 5x5 0.5P	PAGE 1 OF 1

onsemi and Onsemi are trademarks of Semiconductor Components Industries, LLC dba onsemi or its subsidiaries in the United States and/or other countries. onsemi reserves the right to make changes without further notice to any products herein. onsemi makes no warranty, representation or guarantee regarding the suitability of its products for any particular purpose, nor does onsemi assume any liability arising out of the application or use of any product or circuit, and specifically disclaims any and all liability, including without limitation special, consequential or incidental damages. onsemi does not convey any license under its patent rights nor the rights of others.

**LQFP-32, 7x7**  
**CASE 561AB**  
**ISSUE O**

DATE 19 JUN 2008

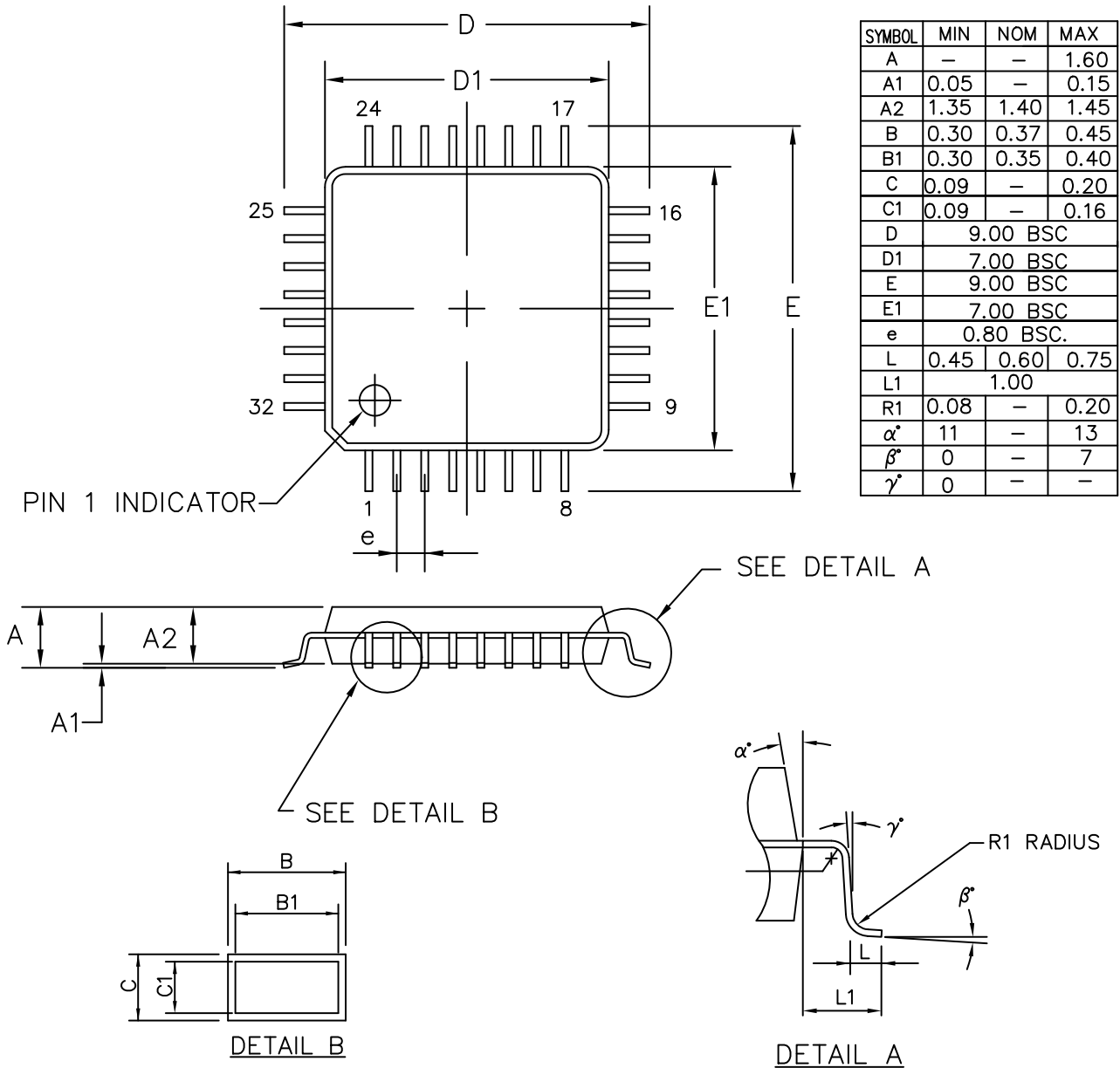

ALL DIMENSIONS IN MM

<b>DOCUMENT NUMBER:</b>	<b>98AON30893E</b>	Electronic versions are uncontrolled except when accessed directly from the Document Repository. Printed versions are uncontrolled except when stamped "CONTROLLED COPY" in red.
<b>DESCRIPTION:</b>	<b>32 LEAD LQFP, 7X7</b>	<b>PAGE 1 OF 1</b>

onsemi and ONSEMI are trademarks of Semiconductor Components Industries, LLC dba onsemi or its subsidiaries in the United States and/or other countries. onsemi reserves the right to make changes without further notice to any products herein. onsemi makes no warranty, representation or guarantee regarding the suitability of its products for any particular purpose, nor does onsemi assume any liability arising out of the application or use of any product or circuit, and specifically disclaims any and all liability, including without limitation special, consequential or incidental damages. onsemi does not convey any license under its patent rights nor the rights of others.

**onsemi**, **Onsemi**, and other names, marks, and brands are registered and/or common law trademarks of Semiconductor Components Industries, LLC dba "**onsemi**" or its affiliates and/or subsidiaries in the United States and/or other countries. **onsemi** owns the rights to a number of patents, trademarks, copyrights, trade secrets, and other intellectual property. A listing of **onsemi**'s product/patent coverage may be accessed at [www.onsemi.com/site/pdf/Patent-Marking.pdf](http://www.onsemi.com/site/pdf/Patent-Marking.pdf). **onsemi** reserves the right to make changes at any time to any products or information herein, without notice. The information herein is provided "as-is" and **onsemi** makes no warranty, representation or guarantee regarding the accuracy of the information, product features, availability, functionality, or suitability of its products for any particular purpose, nor does **onsemi** assume any liability arising out of the application or use of any product or circuit, and specifically disclaims any and all liability, including without limitation special, consequential or incidental damages. Buyer is responsible for its products and applications using **onsemi** products, including compliance with all laws, regulations and safety requirements or standards, regardless of any support or applications information provided by **onsemi**. "Typical" parameters which may be provided in **onsemi** data sheets and/or specifications can and do vary in different applications and actual performance may vary over time. All operating parameters, including "Typicals" must be validated for each customer application by customer's technical experts. **onsemi** does not convey any license under any of its intellectual property rights nor the rights of others. **onsemi** products are not designed, intended, or authorized for use as a critical component in life support systems or any FDA Class 3 medical devices or medical devices with a same or similar classification in a foreign jurisdiction or any devices intended for implantation in the human body. Should Buyer purchase or use **onsemi** products for any such unintended or unauthorized application, Buyer shall indemnify and hold **onsemi** and its officers, employees, subsidiaries, affiliates, and distributors harmless against all claims, costs, damages, and expenses, and reasonable attorney fees arising out of, directly or indirectly, any claim of personal injury or death associated with such unintended or unauthorized use, even if such claim alleges that **onsemi** was negligent regarding the design or manufacture of the part. **onsemi** is an Equal Opportunity/Affirmative Action Employer. This literature is subject to all applicable copyright laws and is not for resale in any manner.

## ADDITIONAL INFORMATION

### TECHNICAL PUBLICATIONS:

Technical Library: [www.onsemi.com/design/resources/technical-documentation](http://www.onsemi.com/design/resources/technical-documentation)  
onsemi Website: [www.onsemi.com](http://www.onsemi.com)

### ONLINE SUPPORT: [www.onsemi.com/support](http://www.onsemi.com/support)

For additional information, please contact your local Sales Representative at [www.onsemi.com/support/sales](http://www.onsemi.com/support/sales)