

Complementary Silicon Power Transistors

MJ15003 (NPN), MJ15004 (PNP)

The MJ15003 and MJ15004 are power transistors designed for high power audio, disk head positioners and other linear applications.

Features

- High Safe Operating Area
- For Low Distortion Complementary Designs
- High DC Current Gain
- These Devices are Pb-Free and are RoHS Compliant*

MAXIMUM RATINGS

Rating	Symbol	Value	Unit
Collector-Emitter Voltage	V_{CEO}	140	Vdc
Collector-Base Voltage	V_{CBO}	140	Vdc
Emitter-Base Voltage	V_{EBO}	5	Vdc
Collector Current - Continuous	I_C	20	Adc
Base Current - Continuous	I_B	5	Adc
Emitter Current - Continuous	I_E	25	Adc
Total Power Dissipation @ $T_C = 25^\circ\text{C}$ Derate above 25°C	P_D	250 1.43	W W/ $^\circ\text{C}$
Operating and Storage Junction Temperature Range	T_J, T_{stg}	-65 to +200	$^\circ\text{C}$

Stresses exceeding Maximum Ratings may damage the device. Maximum Ratings are stress ratings only. Functional operation above the Recommended Operating Conditions is not implied. Extended exposure to stresses above the Recommended Operating Conditions may affect device reliability.

THERMAL CHARACTERISTICS

Characteristic	Symbol	Max	Unit
Thermal Resistance, Junction-to-Case	$R_{\theta JC}$	0.70	$^\circ\text{C}/\text{W}$
Maximum Lead Temperature for Soldering Purposes 1/16" from Case for ≤ 10 secs	T_L	265	$^\circ\text{C}$

20 AMPERE POWER TRANSISTORS COMPLEMENTARY SILICON 140 VOLTS, 250 WATTS

SCHEMATIC

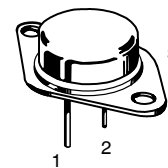
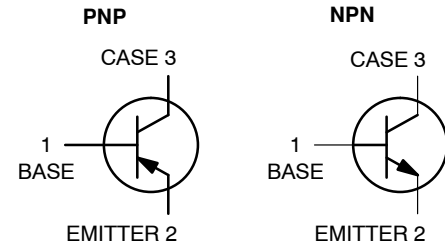

TO-204AA (TO-3)
CASE 1-07
STYLE 1

MARKING DIAGRAM



MJ1500x = Device Code
x = 3 or 4
G = Pb-Free Package
A = Location Code
YY = Year
WW = Work Week
MEX = Country of Origin

ORDERING INFORMATION

Device	Package	Shipping
MJ15003G	TO-204AA (Pb-Free)	100 Units/Tray
MJ15004G	TO-204AA (Pb-Free)	100 Units/Tray

†For information on tape and reel specifications, including part orientation and tape sizes, please refer to our Tape and Reel Packaging Specifications Brochure, [BRD8011/D](#).

*For additional information on our Pb-Free strategy and soldering details, please download the **onsemi** Soldering and Mounting Techniques Reference Manual, SOLDERRM/D.

MJ15003 (NPN), MJ15004 (PNP)

ELECTRICAL CHARACTERISTICS (T_C = 25°C unless otherwise noted)

Characteristic	Symbol	Min	Max	Unit
OFF CHARACTERISTICS				
Collector Emitter Sustaining Voltage (Note 1) (I _C = 200 mAdc, I _B = 0)	V _{CEO(sus)}	140	–	Vdc
Collector Cutoff Current (V _{CE} = 140 Vdc, V _{BE(off)} = 1.5 Vdc) (V _{CE} = 140 Vdc, V _{BE(off)} = 1.5 Vdc, T _C = 150°C)	I _{CEX}	–	100 2	μAdc mAdc
Collector Cutoff Current (V _{CE} = 140 Vdc, I _B = 0)	I _{CEO}	–	250	μAdc
Emitter Cutoff Current (V _{EB} = 5 Vdc, I _C = 0)	I _{EBO}	–	100	μAdc
SECOND BREAKDOWN				
Second Breakdown Collector Current with Base Forward Biased (V _{CE} = 50 Vdc, t = 1 s (non repetitive)) (V _{CE} = 100 Vdc, t = 1 s (non repetitive))	I _{S/b}	5.0 1.0	– –	Adc
ON CHARACTERISTICS				
DC Current Gain (I _C = 5 Adc, V _{CE} = 2 Vdc)	h _{FE}	25	150	–
Collector Emitter Saturation Voltage (I _C = 5 Adc, I _B = 0.5 Adc)	V _{CE(sat)}	–	1.0	Vdc
Base Emitter On Voltage (I _C = 5 Adc, V _{CE} = 2 Vdc)	V _{BE(on)}	–	2.0	Vdc
DYNAMIC CHARACTERISTICS				
Current Gain — Bandwidth Product (I _C = 0.5 Adc, V _{CE} = 10 Vdc, f _{test} = 0.5 MHz)	f _T	2.0	–	MHz
Output Capacitance (V _{CB} = 10 Vdc, I _E = 0, f _{test} = 1 MHz)	c _{ob}	–	1000	pF

1. Pulse Test: Pulse Width = 300 μs, Duty Cycle ≤ 2%.

TYPICAL CHARACTERISTICS MJ15003G (NPN)

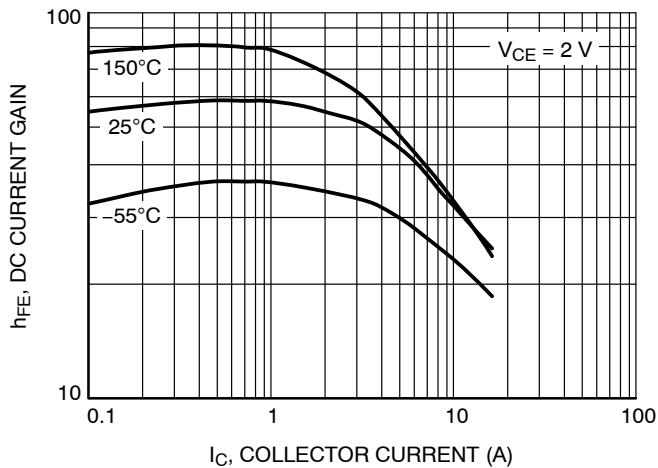

Figure 1. DC Current Gain

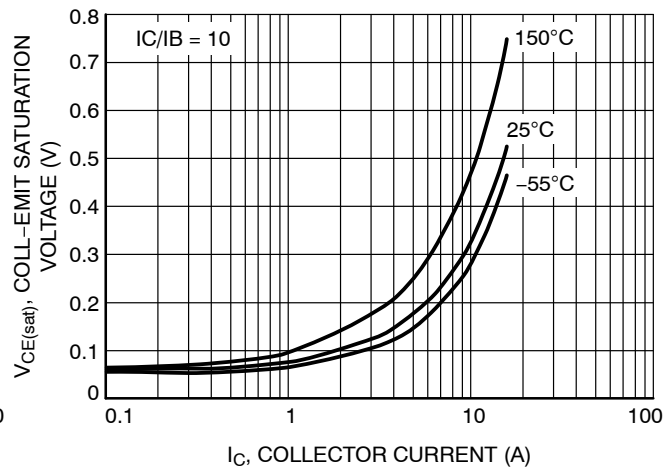

Figure 2. Collector-Emitter Saturation Voltage

MJ15003 (NPN), MJ15004 (PNP)

TYPICAL CHARACTERISTICS MJ15003G (NPN)

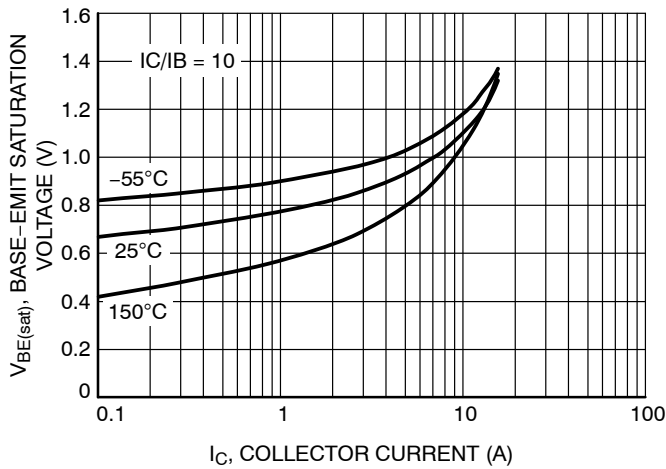

Figure 3. Base-Emitter Saturation Voltage

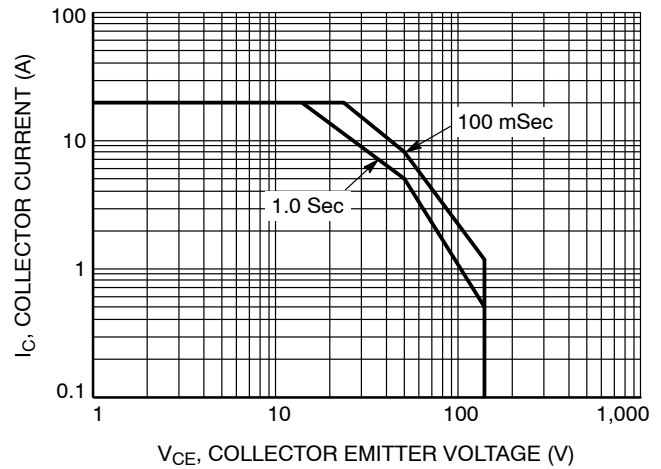

Figure 4. Safe Operating Area

TYPICAL CHARACTERISTICS MJ15004G (PNP)

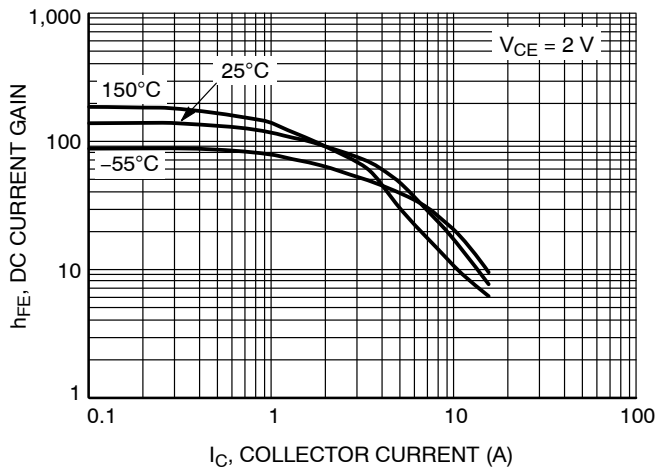

Figure 5. DC Current Gain

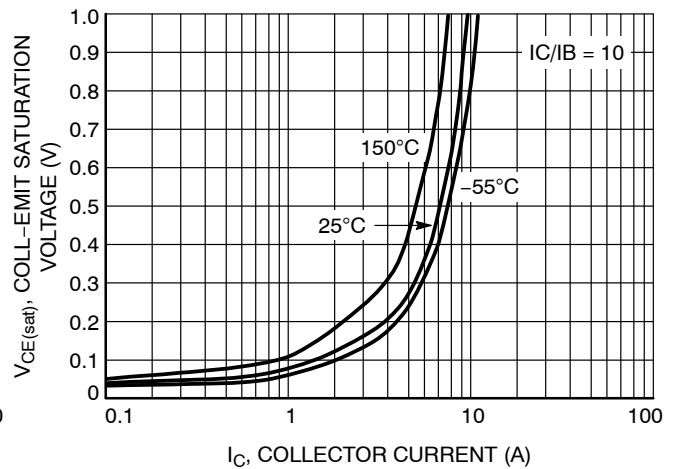

Figure 6. Collector-Emitter Saturation Voltage

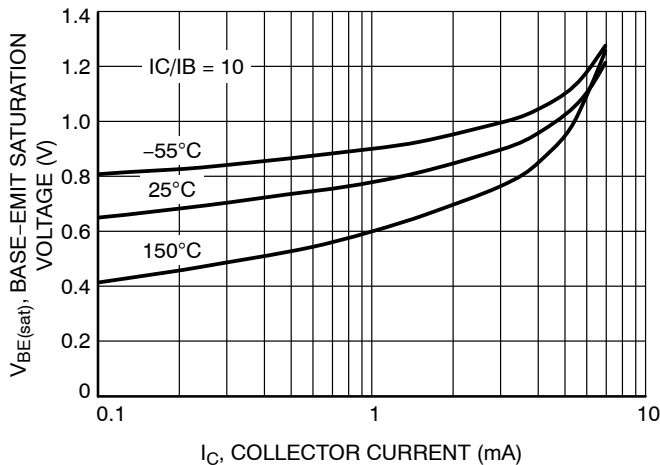

Figure 7. Base-Emitter Saturation Voltage

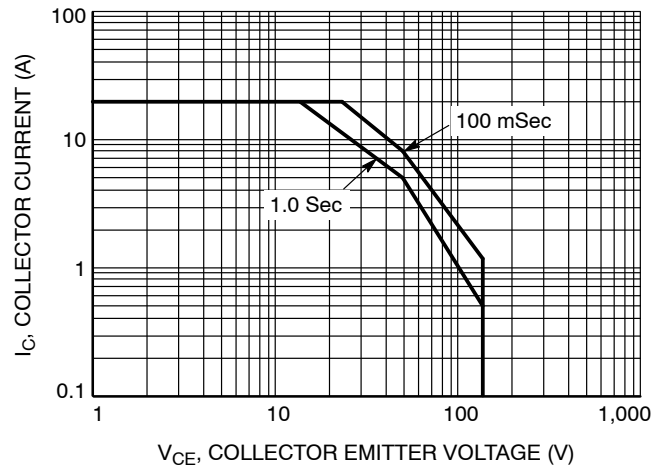
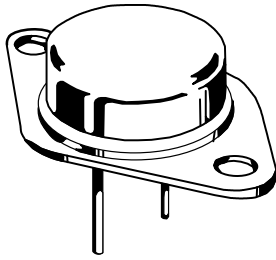

Figure 8. Safe Operating Area



TO-204 (TO-3)
CASE 1-07
ISSUE Z

DATE 10 MAR 2000

SCALE 1:1

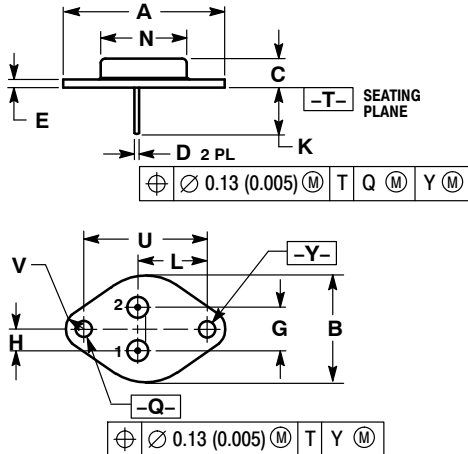

- NOTES:
1. DIMENSIONING AND TOLERANCING PER ANSI Y14.5M, 1982.
 2. CONTROLLING DIMENSION: INCH.
 3. ALL RULES AND NOTES ASSOCIATED WITH REFERENCED TO-204AA OUTLINE SHALL APPLY.

DIM	INCHES		MILLIMETERS	
	MIN	MAX	MIN	MAX
A	1.550 REF		39.37 REF	
B	---	1.050	---	26.67
C	0.250	0.335	6.35	8.51
D	0.038	0.043	0.97	1.09
E	0.055	0.070	1.40	1.77
G	0.430 BSC		10.92 BSC	
H	0.215 BSC		5.46 BSC	
K	0.440	0.480	11.18	12.19
L	0.665 BSC		16.89 BSC	
N	---	0.830	---	21.08
Q	0.151	0.165	3.84	4.19
U	1.187 BSC		30.15 BSC	
V	0.131	0.188	3.33	4.77

- | | | | | |
|--|--|---|---|---|
| <p>STYLE 1:
PIN 1. BASE
2. EMITTER
CASE: COLLECTOR</p> | <p>STYLE 2:
PIN 1. BASE
2. COLLECTOR
CASE: EMITTER</p> | <p>STYLE 3:
PIN 1. GATE
2. SOURCE
CASE: DRAIN</p> | <p>STYLE 4:
PIN 1. GROUND
2. INPUT
CASE: OUTPUT</p> | <p>STYLE 5:
PIN 1. CATHODE
2. EXTERNAL TRIP/DELAY
CASE: ANODE</p> |
| <p>STYLE 6:
PIN 1. GATE
2. EMITTER
CASE: COLLECTOR</p> | <p>STYLE 7:
PIN 1. ANODE
2. OPEN
CASE: CATHODE</p> | <p>STYLE 8:
PIN 1. CATHODE #1
2. CATHODE #2
CASE: ANODE</p> | <p>STYLE 9:
PIN 1. ANODE #1
2. ANODE #2
CASE: CATHODE</p> | |

DOCUMENT NUMBER:	98ASB42001B	Electronic versions are uncontrolled except when accessed directly from the Document Repository. Printed versions are uncontrolled except when stamped "CONTROLLED COPY" in red.
DESCRIPTION:	TO-204 (TO-3)	PAGE 1 OF 1

onsemi and ONSEMI are trademarks of Semiconductor Components Industries, LLC dba onsemi or its subsidiaries in the United States and/or other countries. onsemi reserves the right to make changes without further notice to any products herein. onsemi makes no warranty, representation or guarantee regarding the suitability of its products for any particular purpose, nor does onsemi assume any liability arising out of the application or use of any product or circuit, and specifically disclaims any and all liability, including without limitation special, consequential or incidental damages. onsemi does not convey any license under its patent rights nor the rights of others.

onsemi, **Onsemi**, and other names, marks, and brands are registered and/or common law trademarks of Semiconductor Components Industries, LLC dba "**onsemi**" or its affiliates and/or subsidiaries in the United States and/or other countries. **onsemi** owns the rights to a number of patents, trademarks, copyrights, trade secrets, and other intellectual property. A listing of **onsemi**'s product/patent coverage may be accessed at www.onsemi.com/site/pdf/Patent-Marking.pdf. **onsemi** reserves the right to make changes at any time to any products or information herein, without notice. The information herein is provided "as-is" and **onsemi** makes no warranty, representation or guarantee regarding the accuracy of the information, product features, availability, functionality, or suitability of its products for any particular purpose, nor does **onsemi** assume any liability arising out of the application or use of any product or circuit, and specifically disclaims any and all liability, including without limitation special, consequential or incidental damages. Buyer is responsible for its products and applications using **onsemi** products, including compliance with all laws, regulations and safety requirements or standards, regardless of any support or applications information provided by **onsemi**. "Typical" parameters which may be provided in **onsemi** data sheets and/or specifications can and do vary in different applications and actual performance may vary over time. All operating parameters, including "Typicals" must be validated for each customer application by customer's technical experts. **onsemi** does not convey any license under any of its intellectual property rights nor the rights of others. **onsemi** products are not designed, intended, or authorized for use as a critical component in life support systems or any FDA Class 3 medical devices or medical devices with a same or similar classification in a foreign jurisdiction or any devices intended for implantation in the human body. Should Buyer purchase or use **onsemi** products for any such unintended or unauthorized application, Buyer shall indemnify and hold **onsemi** and its officers, employees, subsidiaries, affiliates, and distributors harmless against all claims, costs, damages, and expenses, and reasonable attorney fees arising out of, directly or indirectly, any claim of personal injury or death associated with such unintended or unauthorized use, even if such claim alleges that **onsemi** was negligent regarding the design or manufacture of the part. **onsemi** is an Equal Opportunity/Affirmative Action Employer. This literature is subject to all applicable copyright laws and is not for resale in any manner.

ADDITIONAL INFORMATION

TECHNICAL PUBLICATIONS:

Technical Library: www.onsemi.com/design/resources/technical-documentation
onsemi Website: www.onsemi.com

ONLINE SUPPORT: www.onsemi.com/support

For additional information, please contact your local Sales Representative at www.onsemi.com/support/sales