

# MJE4343 (NPN), MJE4353 (PNP)

## High-Voltage - High Power Transistors

... designed for use in high power audio amplifier applications and high voltage switching regulator circuits.

### Features

- High Collector–Emitter Sustaining Voltage –  
NPN PNP  
 $V_{CEO(sus)} = 160 \text{ Vdc}$  – MJE4343 MJE4353
- High DC Current Gain – @  $I_C = 8.0 \text{ Adc}$   $h_{FE} = 35$  (Typ)
- Low Collector–Emitter Saturation Voltage –  
 $V_{CE(sat)} = 2.0 \text{ Vdc (Max) @ } I_C = 8.0 \text{ Adc}$
- These are Pb–Free Devices

### MAXIMUM RATINGS

Rating	Symbol	Max	Unit
Collector–Emitter Voltage	$V_{CEO}$	160	Vdc
Collector–Base Voltage	$V_{CB}$	160	Vdc
Emitter–Base Voltage	$V_{EB}$	7.0	Vdc
Collector Current – Continuous Peak (Note 1)	$I_C$	16 20	Adc
Base Current – Continuous	$I_B$	5.0	Adc
Total Power Dissipation @ $T_C = 25^\circ\text{C}$	$P_D$	125	Watts
Operating and Storage Junction Temperature Range	$T_J, T_{stg}$	–65 to +150	$^\circ\text{C}$

### THERMAL CHARACTERISTICS

Characteristic	Symbol	Max	Unit
Thermal Resistance, Junction to Case	$R_{\theta JC}$	1.0	$^\circ\text{C/W}$

1. Pulse Test: Pulse Width  $\leq 5.0 \mu\text{s}$ , Duty Cycle  $\geq 10\%$ .



ON Semiconductor®

<http://onsemi.com>

**16 AMPS  
POWER TRANSISTORS  
COMPLEMENTARY  
SILICON  
160 VOLTS**

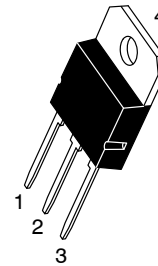

SOT-93  
CASE 340D  
STYLE 1

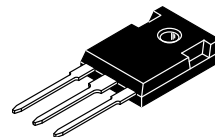

TO-247  
CASE 340L  
STYLE 3

**NOTE: Effective June 2012 this device will be available only in the TO-247 package. Reference FPCN# 16827.**

### ORDERING INFORMATION

See detailed ordering and shipping information in the package dimensions section on page 2 of this data sheet.

# MJE4343 (NPN), MJE4353 (PNP)

## MARKING DIAGRAMS

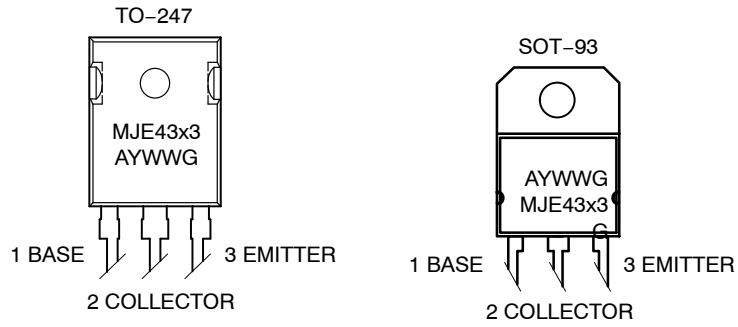

MJE43x3 = Device Code  
 A = Assembly Location  
 Y = Year  
 WW = Work Week  
 G = Pb-Free Package

## ORDERING INFORMATION

Device Order Number	Package Type	Shipping
MJE4343G	SOT-93 (Pb-Free)	30 Units / Rail
MJE4353G	SOT-93 (Pb-Free)	30 Units / Rail
MJE4343G	TO-247 (Pb-Free)	30 Units / Rail
MJE4353G	TO-247 (Pb-Free)	30 Units / Rail

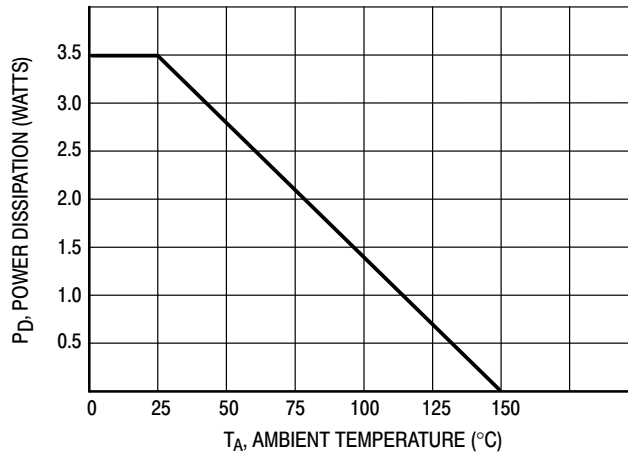

**Figure 1. Power Derating**  
 Reference: Ambient Temperature

## MJE4343 (NPN), MJE4353 (PNP)

### ELECTRICAL CHARACTERISTICS ( $T_C = 25^\circ\text{C}$ unless otherwise noted)

Characteristic	Symbol	Min	Max	Unit
----------------	--------	-----	-----	------

#### OFF CHARACTERISTICS

Collector–Emitter Sustaining Voltage (Note 2) ( $I_C = 200\text{ mA}$ , $I_B = 0$ )	$V_{CEO(sus)}$	160	–	Vdc
Collector–Emitter Cutoff Current ( $V_{CE} = 80\text{ Vdc}$ , $I_B = 0$ )	$I_{CEO}$	–	750	$\mu\text{Adc}$
Collector–Emitter Cutoff Current ( $V_{CE} = \text{Rated } V_{CB}$ , $V_{EB(off)} = 1.5\text{ Vdc}$ ) ( $V_{CE} = \text{Rated } V_{CB}$ , $V_{EB(off)} = 1.5\text{ Vdc}$ , $T_C = 150^\circ\text{C}$ )	$I_{CEX}$	– –	1.0 5.0	mAdc
Collector–Base Cutoff Current ( $V_{CB} = \text{Rated } V_{CB}$ , $I_E = 0$ )	$I_{CBO}$	–	750	$\mu\text{Adc}$
Emitter–Base Cutoff Current ( $V_{BE} = 7.0\text{ Vdc}$ , $I_C = 0$ )	$I_{EBO}$	–	1.0	mAdc

#### ON CHARACTERISTICS (Note 2)

DC Current Gain ( $I_C = 8.0\text{ Adc}$ , $V_{CE} = 2.0\text{ Vdc}$ ) ( $I_C = 16\text{ Adc}$ , $V_{CE} = 4.0\text{ Vdc}$ )	$h_{FE}$	15 8.0	35 (Typ) 15 (Typ)	–
Collector–Emitter Saturation Voltage ( $I_C = 8.0\text{ Adc}$ , $I_B = 800\text{ mA}$ ) ( $I_C = 16\text{ Adc}$ , $I_B = 2.0\text{ Adc}$ )	$V_{CE(sat)}$	– –	2.0 3.5	Vdc
Base–Emitter Saturation Voltage ( $I_C = 16\text{ Adc}$ , $I_B = 2.0\text{ Adc}$ )	$V_{BE(sat)}$	–	3.9	Vdc
Base–Emitter On Voltage ( $I_C = 16\text{ Adc}$ , $V_{CE} = 4.0\text{ Vdc}$ )	$V_{BE(on)}$	–	3.9	Vdc

#### DYNAMIC CHARACTERISTICS

Current–Gain – Bandwidth Product (Note 3) ( $I_C = 1.0\text{ Adc}$ , $V_{CE} = 20\text{ Vdc}$ , $f_{test} = 0.5\text{ MHz}$ )	$f_T$	1.0	–	MHz
Output Capacitance ( $V_{CB} = 10\text{ Vdc}$ , $I_E = 0$ , $f = 0.1\text{ MHz}$ )	$C_{ob}$	–	800	pF

2. Pulse Test: Pulse Width  $\leq 300\ \mu\text{s}$ , Duty Cycle  $\geq 2.0\%$ .

3.  $f_T = |h_{fe}| \cdot f_{test}$ .

# MJE4343 (NPN), MJE4353 (PNP)

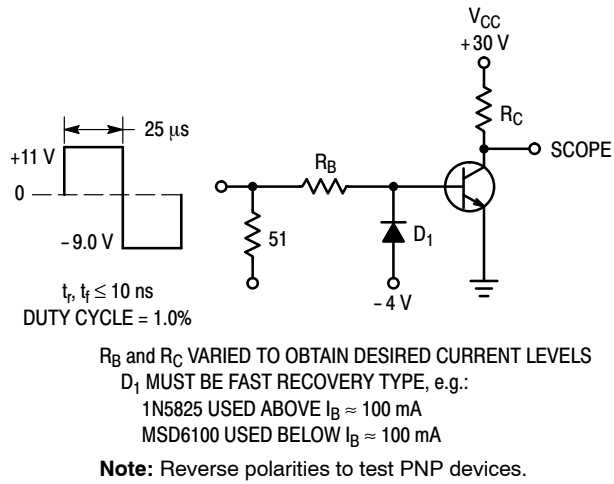

Figure 2. Switching Times Test Circuit

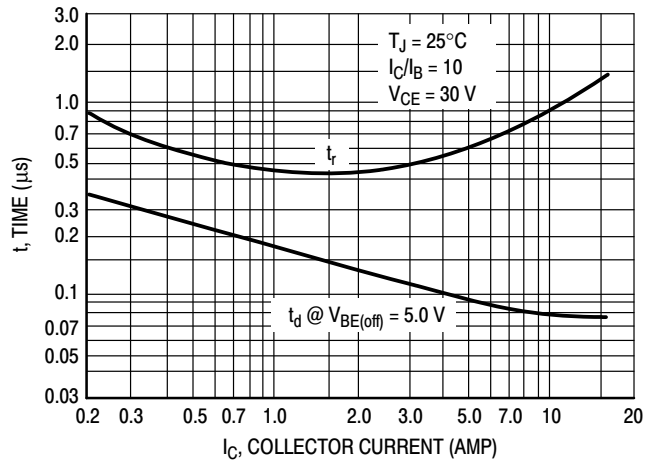

Figure 3. Typical Turn-On Time

## TYPICAL CHARACTERISTICS

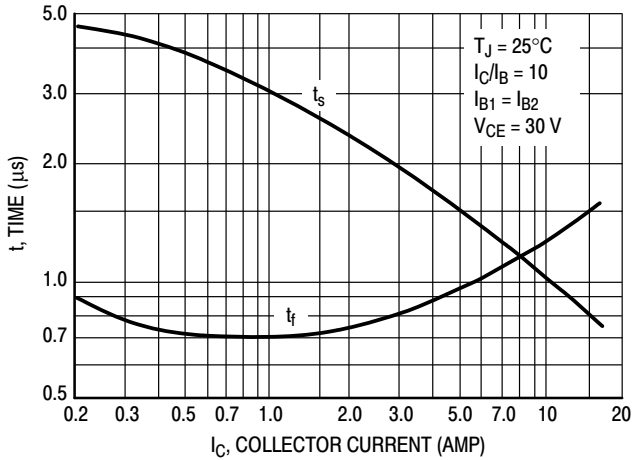

Figure 4. Turn-Off Time

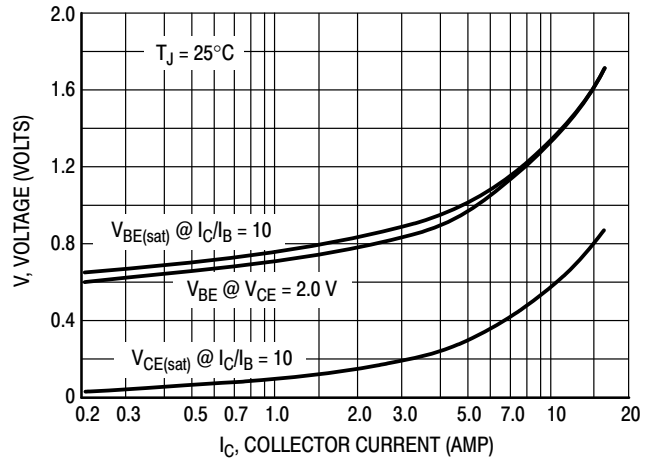

Figure 5. On Voltages

# MJE4343 (NPN), MJE4353 (PNP)

## DC CURRENT GAIN

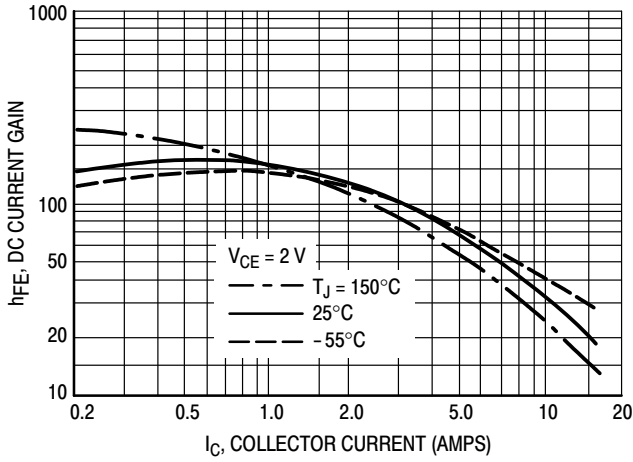

Figure 6. MJE4340 Series (NPN)

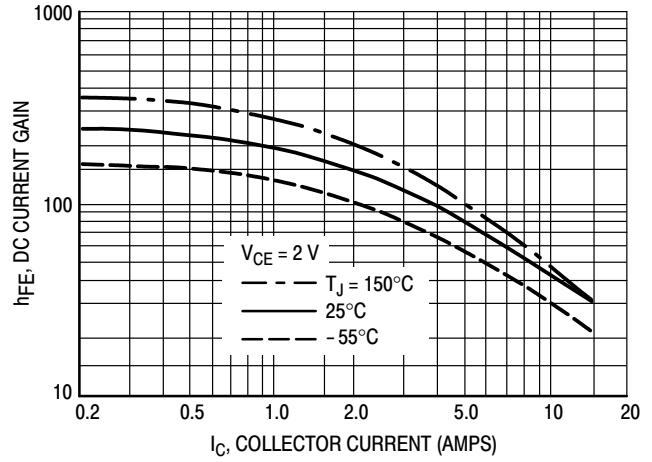

Figure 7. MJE4350 Series (PNP)

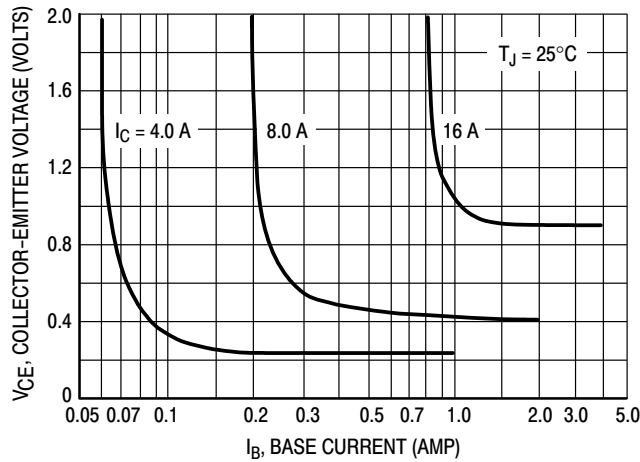

Figure 8. Collector Saturation Region

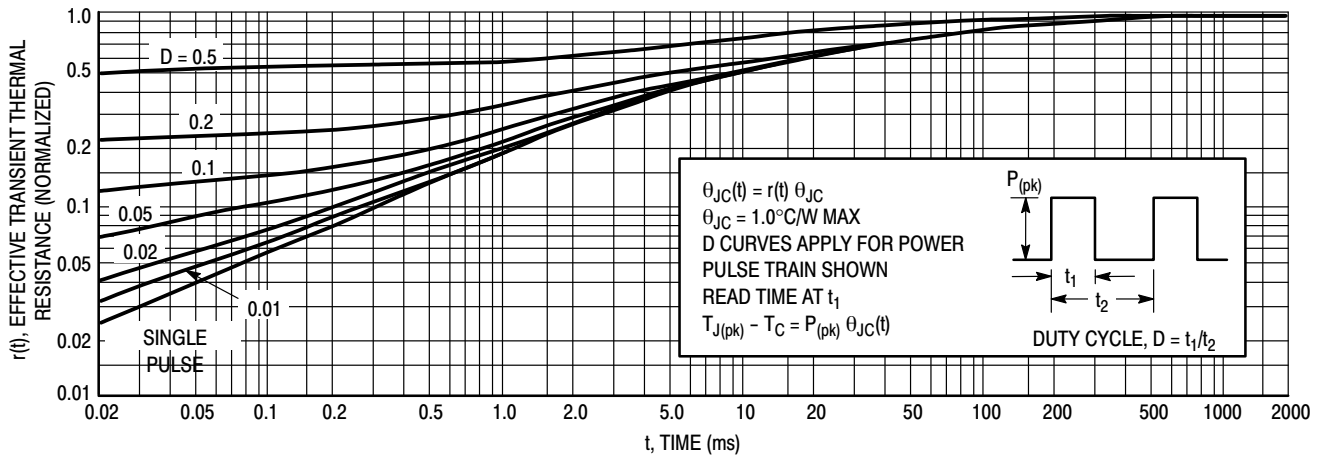
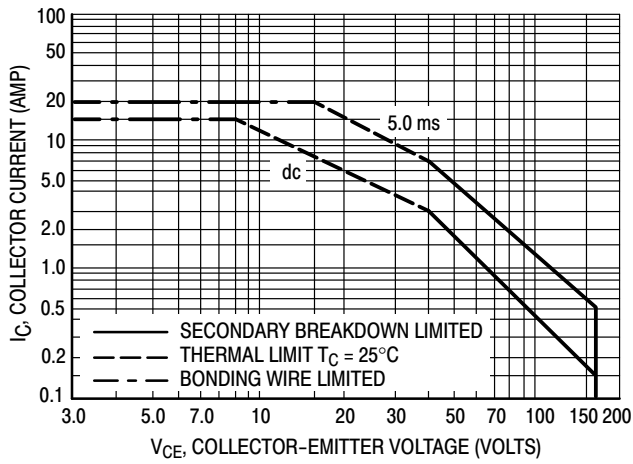

Figure 9. Thermal Response

## MJE4343 (NPN), MJE4353 (PNP)



**Figure 10. Maximum Forward Bias Safe Operating Area**

### REVERSE BIAS

For inductive loads, high voltage and high current must be sustained simultaneously during turn-off, in most cases, with the base to emitter junction reverse biased. Under these conditions the collector voltage must be held to a safe level at or below a specific value of collector current. This can be accomplished by several means such as active clamping, RC snubbing, load line shaping, etc. The safe level for these devices is specified as Reverse Bias Safe Operating Area and represents the voltage-current conditions during reverse biased turn-off. This rating is verified under clamped conditions so that the device is never subjected to an avalanche mode. Figure 11 gives RBSOA characteristics.

There are two limitations on the power handling ability of a transistor: average junction temperature and second breakdown. Safe operating area curves indicate  $I_C - V_{CE}$  limits of the transistor that must be observed for reliable operation; i.e., the transistor must not be subjected to greater dissipation than the curves indicate.

The data of Figure 10 is based on  $T_C = 25^\circ\text{C}$ ;  $T_{J(pk)}$  is variable depending on power level. Second breakdown pulse limits are valid for duty cycles to 10% but must be derated when  $T_C \geq 25^\circ\text{C}$ . Second breakdown limitations do not derate the same as thermal limitations. Allowable current at the voltages shown on Figure 10 may be found at any case temperature by using the appropriate curve on Figure 9.

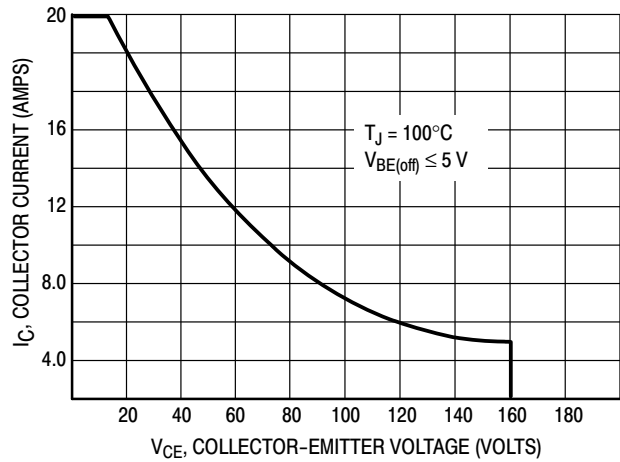

**Figure 11. Maximum Reverse Bias Safe Operating Area**

# MECHANICAL CASE OUTLINE

## PACKAGE DIMENSIONS

ON Semiconductor®



### SOT-93 (TO-218) CASE 340D-02 ISSUE E

DATE 01/03/2002



SCALE 1:1



STYLE 1:  
PIN 1. BASE  
2. COLLECTOR  
3. EMITTER  
4. COLLECTOR

STYLE 2:  
PIN 1. ANODE  
2. CATHODE  
3. ANODE  
4. CATHODE

- NOTES:  
1. DIMENSIONING AND TOLERANCING PER ANSI Y14.5M, 1982.  
2. CONTROLLING DIMENSION: MILLIMETER.

DIM	MILLIMETERS		INCHES	
	MIN	MAX	MIN	MAX
A	---	20.35	---	0.801
B	14.70	15.20	0.579	0.598
C	4.70	4.90	0.185	0.193
D	1.10	1.30	0.043	0.051
E	1.17	1.37	0.046	0.054
G	5.40	5.55	0.213	0.219
H	2.00	3.00	0.079	0.118
J	0.50	0.78	0.020	0.031
K	31.00 REF		1.220 REF	
L	---	16.20	---	0.638
Q	4.00	4.10	0.158	0.161
S	17.80	18.20	0.701	0.717
U	4.00 REF		0.157 REF	
V	1.75 REF		0.069	

### MARKING DIAGRAM



A = Assembly Location  
Y = Year  
WV = Work Week  
xxxxx = Device Code

<b>DOCUMENT NUMBER:</b>	<b>98ASB42643B</b>	Electronic versions are uncontrolled except when accessed directly from the Document Repository. Printed versions are uncontrolled except when stamped "CONTROLLED COPY" in red.
<b>DESCRIPTION:</b>	<b>SOT-93</b>	<b>PAGE 1 OF 1</b>

ON Semiconductor and are trademarks of Semiconductor Components Industries, LLC dba ON Semiconductor or its subsidiaries in the United States and/or other countries. ON Semiconductor reserves the right to make changes without further notice to any products herein. ON Semiconductor makes no warranty, representation or guarantee regarding the suitability of its products for any particular purpose, nor does ON Semiconductor assume any liability arising out of the application or use of any product or circuit, and specifically disclaims any and all liability, including without limitation special, consequential or incidental damages. ON Semiconductor does not convey any license under its patent rights nor the rights of others.

# MECHANICAL CASE OUTLINE PACKAGE DIMENSIONS



TO-247  
CASE 340L  
ISSUE G

DATE 06 OCT 2021

SCALE 1:1



NOTES:

1. DIMENSIONING AND TOLERANCING PER ASME Y14.5M, 1982.
2. CONTROLLING DIMENSION: MILLIMETER

DIM	MILLIMETERS		INCHES	
	MIN.	MAX.	MIN.	MAX.
A	20.32	21.08	0.800	0.830
B	15.75	16.26	0.620	0.640
C	4.70	5.30	0.185	0.209
D	1.00	1.40	0.040	0.055
E	1.90	2.60	0.075	0.102
F	1.65	2.13	0.065	0.084
G	5.45 BSC		0.215 BSC	
H	1.50	2.49	0.059	0.098
J	0.40	0.80	0.016	0.031
K	19.81	20.83	0.780	0.820
L	5.40	6.20	0.212	0.244
N	4.32	5.49	0.170	0.216
P	----	4.50	----	0.177
Q	3.55	3.65	0.140	0.144
U	6.15 BSC		0.242 BSC	
W	2.87	3.12	0.113	0.123

GENERIC  
MARKING DIAGRAM\*

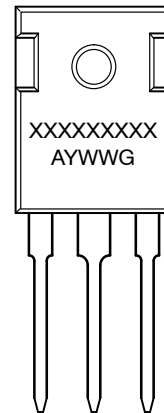

- |  |  |  |  |
|--|--|--|--|
| <p>STYLE 1:<br/>PIN 1. GATE<br/>2. DRAIN<br/>3. SOURCE<br/>4. DRAIN</p>  | <p>STYLE 2:<br/>PIN 1. ANODE<br/>2. CATHODE (S)<br/>3. ANODE 2<br/>4. CATHODES (S)</p>               | <p>STYLE 3:<br/>PIN 1. BASE<br/>2. COLLECTOR<br/>3. EMITTER<br/>4. COLLECTOR</p> | <p>STYLE 4:<br/>PIN 1. GATE<br/>2. COLLECTOR<br/>3. EMITTER<br/>4. COLLECTOR</p> |
| <p>STYLE 5:<br/>PIN 1. CATHODE<br/>2. ANODE<br/>3. GATE<br/>4. ANODE</p> | <p>STYLE 6:<br/>PIN 1. MAIN TERMINAL 1<br/>2. MAIN TERMINAL 2<br/>3. GATE<br/>4. MAIN TERMINAL 2</p> |  |  |

- XXXXX = Specific Device Code  
A = Assembly Location  
Y = Year  
WW = Work Week  
G = Pb-Free Package

\*This information is generic. Please refer to device data sheet for actual part marking. Pb-Free indicator, "G" or microdot "▪", may or may not be present. Some products may not follow the Generic Marking.

DOCUMENT NUMBER:	98ASB15080C	Electronic versions are uncontrolled except when accessed directly from the Document Repository. Printed versions are uncontrolled except when stamped "CONTROLLED COPY" in red.
DESCRIPTION:	TO-247	PAGE 1 OF 1

onsemi and onsemi are trademarks of Semiconductor Components Industries, LLC dba onsemi or its subsidiaries in the United States and/or other countries. onsemi reserves the right to make changes without further notice to any products herein. onsemi makes no warranty, representation or guarantee regarding the suitability of its products for any particular purpose, nor does onsemi assume any liability arising out of the application or use of any product or circuit, and specifically disclaims any and all liability, including without limitation special, consequential or incidental damages. onsemi does not convey any license under its patent rights nor the rights of others.



**onsemi**, **Onsemi**, and other names, marks, and brands are registered and/or common law trademarks of Semiconductor Components Industries, LLC dba "**onsemi**" or its affiliates and/or subsidiaries in the United States and/or other countries. **onsemi** owns the rights to a number of patents, trademarks, copyrights, trade secrets, and other intellectual property. A listing of **onsemi**'s product/patent coverage may be accessed at [www.onsemi.com/site/pdf/Patent-Marking.pdf](http://www.onsemi.com/site/pdf/Patent-Marking.pdf). **onsemi** reserves the right to make changes at any time to any products or information herein, without notice. The information herein is provided "as-is" and **onsemi** makes no warranty, representation or guarantee regarding the accuracy of the information, product features, availability, functionality, or suitability of its products for any particular purpose, nor does **onsemi** assume any liability arising out of the application or use of any product or circuit, and specifically disclaims any and all liability, including without limitation special, consequential or incidental damages. Buyer is responsible for its products and applications using **onsemi** products, including compliance with all laws, regulations and safety requirements or standards, regardless of any support or applications information provided by **onsemi**. "Typical" parameters which may be provided in **onsemi** data sheets and/or specifications can and do vary in different applications and actual performance may vary over time. All operating parameters, including "Typicals" must be validated for each customer application by customer's technical experts. **onsemi** does not convey any license under any of its intellectual property rights nor the rights of others. **onsemi** products are not designed, intended, or authorized for use as a critical component in life support systems or any FDA Class 3 medical devices or medical devices with a same or similar classification in a foreign jurisdiction or any devices intended for implantation in the human body. Should Buyer purchase or use **onsemi** products for any such unintended or unauthorized application, Buyer shall indemnify and hold **onsemi** and its officers, employees, subsidiaries, affiliates, and distributors harmless against all claims, costs, damages, and expenses, and reasonable attorney fees arising out of, directly or indirectly, any claim of personal injury or death associated with such unintended or unauthorized use, even if such claim alleges that **onsemi** was negligent regarding the design or manufacture of the part. **onsemi** is an Equal Opportunity/Affirmative Action Employer. This literature is subject to all applicable copyright laws and is not for resale in any manner.

## ADDITIONAL INFORMATION

### TECHNICAL PUBLICATIONS:

Technical Library: [www.onsemi.com/design/resources/technical-documentation](http://www.onsemi.com/design/resources/technical-documentation)  
onsemi Website: [www.onsemi.com](http://www.onsemi.com)

### ONLINE SUPPORT: [www.onsemi.com/support](http://www.onsemi.com/support)

For additional information, please contact your local Sales Representative at [www.onsemi.com/support/sales](http://www.onsemi.com/support/sales)