

# TinyLogic ULP-A Universal Configurable Logic Gates

## NC7SV57, NC7SV58

The NC7SV57 and NC7SV58 are universal configurable logic gates in tiny footprint packages. The devices are designed to operate for  $V_{CC} = 0.9\text{ V}$  to  $3.6\text{ V}$ .

### Features

- Designed for 0.9 V to 3.6 V  $V_{CC}$  Operation
- 2.4 ns  $t_{PD}$  at 3.3 V (Typ)
- Inputs/Outputs Over-Voltage Tolerant up to 3.6 V
- $I_{OFF}$  Supports Partial Power Down Protection
- Source/Sink 24 mA at 3.3 V
- Available in SC-88 and MicroPak™ Packages
- These Devices are Pb-Free, Halogen Free/BFR Free and are RoHS Compliant

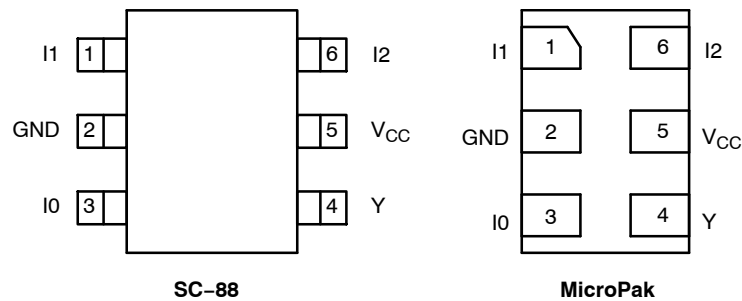

Figure 1. Pinout Diagrams (Top Views)

### PIN ASSIGNMENT

Pin	SC-88	MicroPak
1	I1	I1
2	GND	GND
3	I0	I0
4	Y	Y
5	$V_{CC}$	$V_{CC}$
6	I2	I2

### MARKING DIAGRAM



SIP6 1.45X1.0  
MicroPak  
CASE 127EB

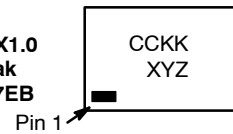

UDFN6 1.0X1.0, 0.35P  
MicroPak2™  
CASE 517DP

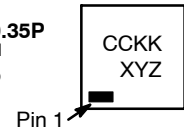

CC = Specific Device Code  
KK = 2-Digit Lot Run Traceability Code  
XY = 2-Digit Date Code  
Z = Assembly Plant Code

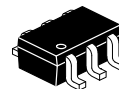

SC-88  
CASE 419AD

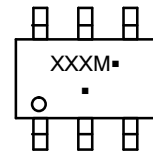

XXX = Specific Device Code  
M = Date Code  
▪ = Pb-Free Package

### ORDERING INFORMATION

See detailed ordering, marking and shipping information on page 9 of this data sheet.

## NC7SV57, NC7SV58

**FUNCTION TABLE**

Inputs			NC7SV57	NC7SV58
I2	I1	I0	$Y = (\overline{I0}) \cdot (\overline{I2}) + (I1) \cdot (I2)$	$Y = (I0) \cdot (\overline{I2}) + (\overline{I1}) \cdot (I2)$
L	L	L	H	L
L	L	H	L	H
L	H	L	H	L
L	H	H	L	H
H	L	L	L	H
H	L	H	L	H
H	H	L	H	L
H	H	H	H	L

**FUNCTION SELECTION TABLE**

2-Input Logic Function	Device Selection	Connection Configuration
2-Input AND	NC7SV57	Figure 2
2-Input AND with inverted input	NC7SV58	Figure 8, 9
2-Input AND with both inputs inverted	NC7SV57	Figure 5
2-Input NAND	NC7SV58	Figure 7
2-Input NAND with inverted input	NC7SV57	Figure 3, 4
2-Input NAND with both inputs inverted	NC7SV58	Figure 10
2-Input OR	NC7SV58	Figure 10
2-Input OR with inverted input	NC7SV57	Figure 3, 4
2-Input OR with both inputs inverted	NC7SV58	Figure 7
2-Input NOR	NC7SV57	Figure 5
2-Input NOR with inverted input	NC7SV58	Figure 8, 9
2-Input NOR with both inputs inverted	NC7SV57	Figure 2
2-Input XOR	NC7SV58	Figure 11
2-Input XNOR	NC7SV57	Figure 6

# NC7SV57, NC7SV58

## Logic Configurations NC7SV57

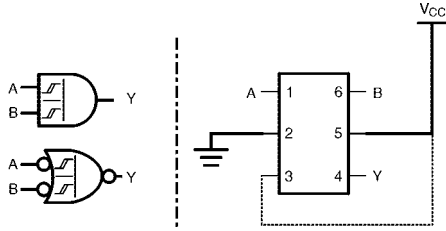

Figure 2. 2-Input AND Gate

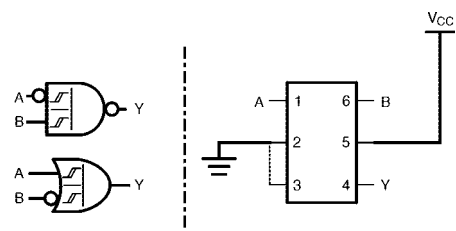

Figure 3. 2-Input NAND with Inverted A Input

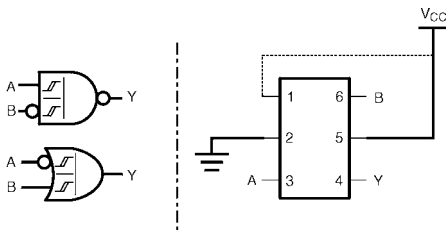

Figure 4. 2-Input NAND with Inverted B Input

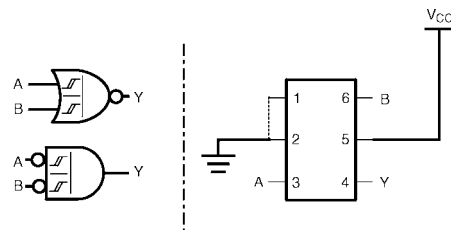

Figure 5. 2-Input NOR Gate

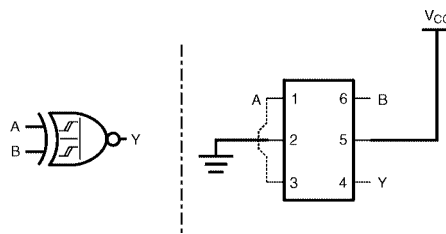

Figure 6. 2-Input XNOR Gate

NOTE: Figure 2 through Figure 6 show the logical functions that can be implemented using the NC7SV57. The diagrams show the DeMorgan's equivalent logic duals for a given 2-input function. Next to the logical implementation is the board level physical implementation of how the pins of the function should be connected.

# NC7SV57, NC7SV58

## Logic Configurations NC7SV58

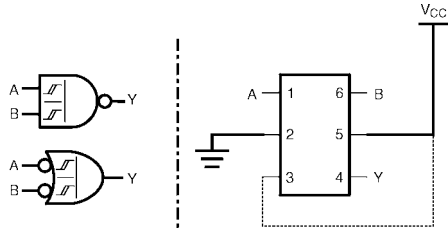

Figure 7. 2-Input NAND Gate

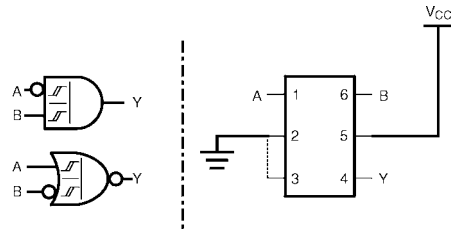

Figure 8. 2-Input AND with Inverted A Input

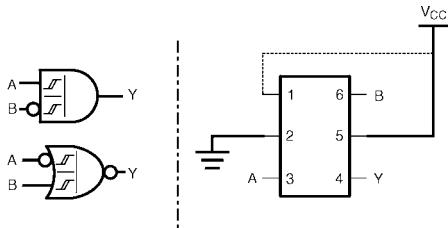

Figure 9. 2-Input AND with Inverted B Input

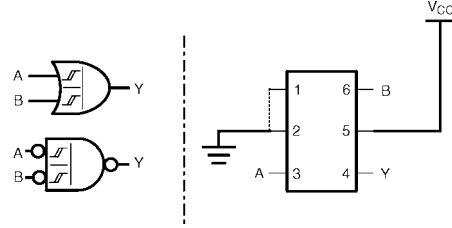

Figure 10. 2-Input OR Gate

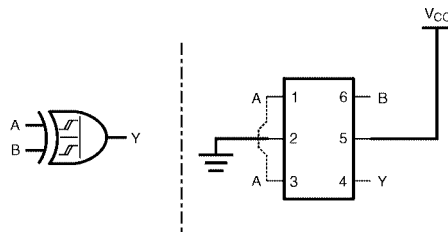

Figure 11. 2-Input XOR Gate

NOTE: Figure 7 through Figure 11 show the logical functions that can be implemented using the NC7SV58. The diagrams show the DeMorgan's equivalent logic duals for a given 2-input function. Next to the logical implementation is the board level physical implementation of how the pins of the function should be connected.

# NC7SV57, NC7SV58

## MAXIMUM RATINGS

Symbol	Characteristics	Value	Unit
V <sub>CC</sub>	DC Supply Voltage	-0.5 to +4.3	V
V <sub>IN</sub>	DC Input Voltage	-0.5 to +4.3	V
V <sub>OUT</sub>	DC Output Voltage Active-Mode (High or Low State) Tri-State Mode (Note 1) Power-Down Mode (V <sub>CC</sub> = 0 V)	-0.5 to V <sub>CC</sub> + 0.5 -0.5 to +4.3 -0.5 to +4.3	V
I <sub>IK</sub>	DC Input Diode Current V <sub>IN</sub> < GND	-50	mA
I <sub>OK</sub>	DC Output Diode Current V <sub>OUT</sub> < GND	-50	mA
I <sub>OUT</sub>	DC Output Source/Sink Current	±50	mA
I <sub>CC</sub> or I <sub>GND</sub>	DC Supply Current per Supply Pin or Ground Pin	±50	mA
T <sub>STG</sub>	Storage Temperature Range	-65 to +150	°C
T <sub>L</sub>	Lead Temperature, 1 mm from Case for 10 Seconds	260	°C
T <sub>J</sub>	Junction Temperature Under Bias	+150	°C
θ <sub>JA</sub>	Thermal Resistance (Note 2) SC-88 MicroPak	377 154	°C/W
P <sub>D</sub>	Power Dissipation in Still Air SC-88 MicroPak	332 812	mW
MSL	Moisture Sensitivity	Level 1	
F <sub>R</sub>	Flammability Rating Oxygen Index: 28 to 34	UL 94 V-0 @ 0.125 in	
V <sub>ESD</sub>	ESD Withstand Voltage (Note 3) Human Body Model Charged Device Model	2000 1000	V
I <sub>Latchup</sub>	Latchup Performance (Note 4)	±100	mA

Stresses exceeding those listed in the Maximum Ratings table may damage the device. If any of these limits are exceeded, device functionality should not be assumed, damage may occur and reliability may be affected.

1. Applicable to devices with outputs that may be tri-stated.
2. Measured with minimum pad spacing on an FR4 board, using 10 mm-by-1 inch, 2 ounce copper trace no air flow per JESD51-7.
3. HBM tested to EIA / JESD22-A114-A. CDM tested to JESD22-C101-A. JEDEC recommends that ESD qualification to EIA/JESD22-A115A (Machine Model) be discontinued.
4. Tested to EIA/JESD78 Class II.

## RECOMMENDED OPERATING CONDITIONS

Symbol	Parameter	Min	Max	Unit
V <sub>CC</sub>	Positive DC Supply Voltage	0.9	3.6	V
V <sub>IN</sub>	DC Input Voltage	0	3.6	V
V <sub>OUT</sub>	DC Output Voltage Active-Mode (High or Low State) Tri-State Mode (Note 5) Power-Down Mode (V <sub>CC</sub> = 0 V)	0 0 0	V <sub>CC</sub> 3.6 3.6	V
T <sub>A</sub>	Operating Temperature Range	-40	+85	°C
t <sub>r</sub> , t <sub>f</sub>	Input Transition Rise and Fall Time	0	No Limit	ns/V

Functional operation above the stresses listed in the Recommended Operating Ranges is not implied. Extended exposure to stresses beyond the Recommended Operating Ranges limits may affect device reliability.

5. Applicable to devices with outputs that may be tri-stated.

# NC7SV57, NC7SV58

## DC ELECTRICAL CHARACTERISTICS

Symbol	Parameter	Condition	V <sub>CC</sub> (V)	T <sub>A</sub> = 25°C			T <sub>A</sub> = -40°C to +85°C		Unit
				Min	Typ	Max	Min	Max	
V <sub>P</sub>	Positive Threshold Voltage		0.9	-	0.62	-	-	-	V
			1.1	-	-	1.0	-	1.0	
			1.4	-	-	1.25	-	1.25	
			1.65	-	-	1.5	-	1.5	
			2.3	-	-	1.8	-	1.8	
			2.7	-	-	2.2	-	2.2	
V <sub>N</sub>	Negative Threshold Voltage		0.9	-	0.34	-	-	-	V
			1.1	0.15	-	-	0.15	-	
			1.4	0.2	-	-	0.2	-	
			1.65	0.25	-	-	0.25	-	
			2.3	0.4	-	-	0.4	-	
			2.7	0.6	-	-	0.6	-	
V <sub>H</sub>	Hysteresis Voltage		0.9	-	0.29	-	-	-	V
			1.1	0.08	-	0.6	0.08	0.6	
			1.4	0.09	-	0.8	0.09	0.8	
			1.65	0.15	-	1.0	0.15	1.0	
			2.3	0.25	-	1.1	0.25	1.1	
			2.7	0.6	-	1.2	0.6	1.2	
V <sub>OH</sub>	High-Level Output Voltage	V <sub>IN</sub> = V <sub>IH</sub> or V <sub>IL</sub>							V
		I <sub>OH</sub> = -100 μA	0.9	-	V <sub>CC</sub> - 0.1	-	-	-	
			1.1 to 1.3	V <sub>CC</sub> - 0.1	-	-	V <sub>CC</sub> - 0.1	-	
			1.4 to 1.6	V <sub>CC</sub> - 0.1	-	-	V <sub>CC</sub> - 0.1	-	
			1.65 to 1.95	V <sub>CC</sub> - 0.2	-	-	V <sub>CC</sub> - 0.2	-	
			2.3 to <2.7	V <sub>CC</sub> - 0.2	-	-	V <sub>CC</sub> - 0.2	-	
			2.7 to 3.6	V <sub>CC</sub> - 0.2	-	-	V <sub>CC</sub> - 0.2	-	
		I <sub>OH</sub> = -2 mA	1.1 to 1.3	0.75 x V <sub>CC</sub>	-	-	0.75 x V <sub>CC</sub>	-	
		I <sub>OH</sub> = -4 mA	1.4 to 1.6	0.75 x V <sub>CC</sub>	-	-	0.75 x V <sub>CC</sub>	-	
		I <sub>OH</sub> = -6 mA	1.65 to 1.95	1.25	-	-	1.25	-	
			2.3 to <2.7	2.0	-	-	2.0	-	
		I <sub>OH</sub> = -12 mA	2.3 to <2.7	1.8	-	-	1.8	-	
			2.7 to 3.6	2.2	-	-	2.2	-	
		I <sub>OH</sub> = -18 mA	2.3 to <2.7	1.7	-	-	1.7	-	
			2.7 to 3.6	2.4	-	-	2.4	-	
I <sub>OH</sub> = -24 mA	2.7 to 3.6	2.2	-	-	2.2	-			

# NC7SV57, NC7SV58

## DC ELECTRICAL CHARACTERISTICS (continued)

Symbol	Parameter	Condition	V <sub>CC</sub> (V)	T <sub>A</sub> = 25°C			T <sub>A</sub> = -40°C to +85°C		Unit	
				Min	Typ	Max	Min	Max		
V <sub>OL</sub>	Low-Level Output Voltage	V <sub>IN</sub> = V <sub>IH</sub> or V <sub>IL</sub>							V	
		I <sub>OL</sub> = 100 μA	0.9	-	0.1	-	-	-		-
			1.1 to 1.3	-	-	0.1	-	0.1		-
			1.4 to 1.6	-	-	0.1	-	0.1		-
			1.65 to 1.95	-	-	0.2	-	0.2		-
			2.3 to < 2.7	-	-	0.2	-	0.2		-
			2.7 to 3.6	-	-	0.2	-	0.2		-
		I <sub>OL</sub> = 2 mA	1.1 to 1.3	-	-	0.25 x V <sub>CC</sub>	-	0.25 x V <sub>CC</sub>		-
		I <sub>OL</sub> = 4 mA	1.4 to 1.6	-	-	0.25 x V <sub>CC</sub>	-	0.25 x V <sub>CC</sub>		-
		I <sub>OL</sub> = 6 mA	1.65 to 1.95	-	-	0.3	-	0.3		-
		I <sub>OL</sub> = 12 mA	2.3 to < 2.7	-	-	0.4	-	0.4		-
			2.7 to 3.6	-	-	0.4	-	0.4		-
		I <sub>OL</sub> = 18 mA	2.3 to < 2.7	-	-	0.6	-	0.6		-
			2.7 to 3.6	-	-	0.4	-	0.4		-
I <sub>OL</sub> = 24 mA	2.7 to 3.6	-	-	0.55	-	0.55	-			
I <sub>IN</sub>	Input Leakage Current	V <sub>IN</sub> = 0 V to 3.6 V	0.9 to 3.6	-	-	±0.1	-	±0.5	μA	
I <sub>OFF</sub>	Power Off Leakage Current	V <sub>IN</sub> = 0 V to 3.6 V or V <sub>OUT</sub> = 0 V to 3.6 V	0	-	-	0.5	-	0.5	μA	
I <sub>CC</sub>	Quiescent Supply Current	V <sub>IN</sub> = V <sub>CC</sub> or GND	0.9 to 3.6	-	-	0.9	-	0.9	μA	

Product parametric performance is indicated in the Electrical Characteristics for the listed test conditions, unless otherwise noted. Product performance may not be indicated by the Electrical Characteristics if operated under different conditions.

## AC ELECTRICAL CHARACTERISTICS

Symbol	Parameter	Condition	V <sub>CC</sub> (V)	T <sub>A</sub> = 25°C			T <sub>A</sub> = -40°C to +85°C		Unit
				Min	Typ	Max	Min	Max	
t <sub>PLH</sub> , t <sub>PHL</sub>	Propagation Delay, (I <sub>0</sub> or I <sub>1</sub> or I <sub>2</sub> ) to Y (Figures 12 and 13)	R <sub>L</sub> = 1 MΩ, C <sub>L</sub> = 15 pF	0.9	-	22.2	-	-	-	ns
		R <sub>L</sub> = 2 kΩ, C <sub>L</sub> = 15 pF	1.10 to 1.30	-	7.1	16.5	-	31.0	
			1.40 to 1.60	-	4.4	10.0	-	12.0	
		R <sub>L</sub> = 500 Ω, C <sub>L</sub> = 30 pF	1.65 to 1.95	-	3.7	9.1	-	10.0	
			2.3 to 2.7	-	2.9	6.2	-	6.7	
			3.0 to 3.6	-	2.4	5.4	-	6.1	

## CAPACITIVE CHARACTERISTICS

Symbol	Parameter	Test Condition	Typical (T <sub>A</sub> = 25°C)	Unit
C <sub>IN</sub>	Input Capacitance	V <sub>CC</sub> = 0 V	8.0	pF
C <sub>OUT</sub>	Output Capacitance	V <sub>CC</sub> = 0 V	12	pF
C <sub>PD</sub>	Power Dissipation Capacitance (Note 6)	f = 10 MHz, V <sub>CC</sub> = 0.9 to 3.6 V, V <sub>IN</sub> = 0 V or V <sub>CC</sub>	10	pF

6. C<sub>PD</sub> is defined as the value of the internal equivalent capacitance which is calculated from the operating current consumption without load. Average operating current can be obtained by the equation I<sub>CC(OPR)</sub> = C<sub>PD</sub> • V<sub>CC</sub> • f<sub>in</sub> + I<sub>CC</sub>. C<sub>PD</sub> is used to determine the no-load dynamic power consumption: P<sub>D</sub> = C<sub>PD</sub> • V<sub>CC</sub><sup>2</sup> • f<sub>in</sub> + I<sub>CC</sub> • V<sub>CC</sub>.

# NC7SV57, NC7SV58

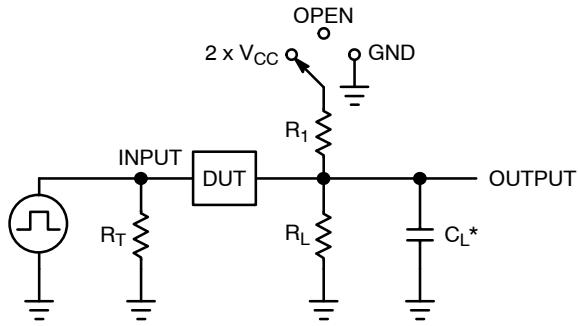

$C_L$  includes probe and jig capacitance  
 $R_T$  is  $Z_{OUT}$  of pulse generator (typically 50  $\Omega$ )  
 $f = 1$  MHz

Test	Switch Position
$t_{PLH} / t_{PHL}$	Open
$t_{PLZ} / t_{PZL}$	$2 \times V_{CC}$
$t_{PHZ} / t_{PZH}$	GND

Figure 12. Test Circuit

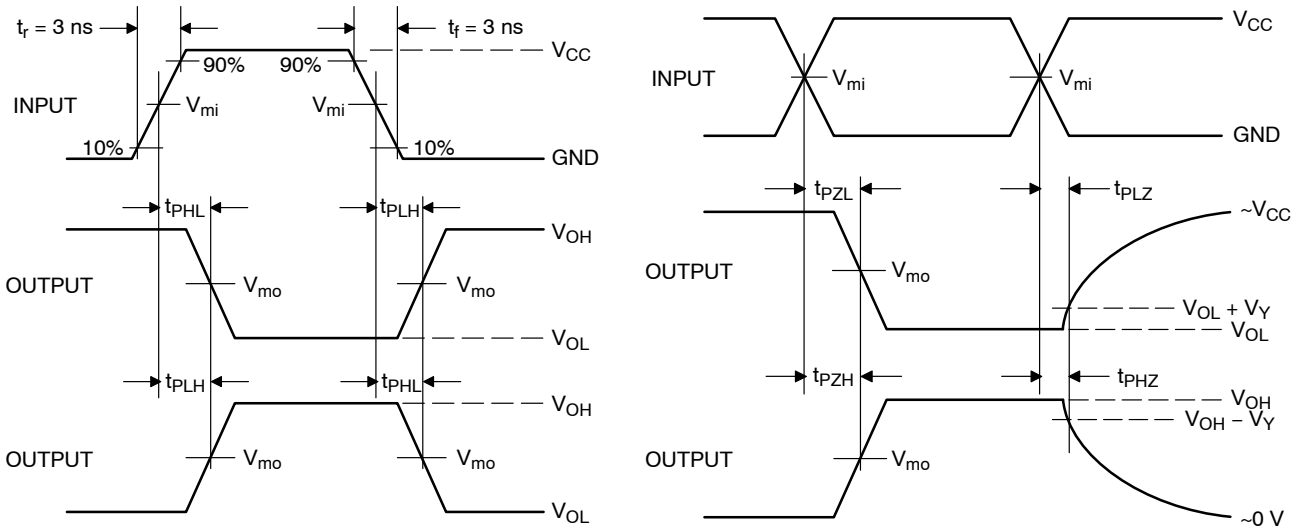

$V_{CC}, V$	$V_{mi}, V$	$V_{mo}, V$	$V_Y, V$
0.9	$V_{CC} / 2$	$V_{CC} / 2$	0.1
1.1 to 1.3	$V_{CC} / 2$	$V_{CC} / 2$	0.1
1.4 to 1.6	$V_{CC} / 2$	$V_{CC} / 2$	0.1
1.65 to 1.95	$V_{CC} / 2$	$V_{CC} / 2$	0.15
2.3 to 2.7	$V_{CC} / 2$	$V_{CC} / 2$	0.15
3.0 to 3.6	1.5	1.5	0.3

Figure 13. Switching Waveforms



# NC7SV57, NC7SV58

## ORDERING INFORMATION

Device	Package	Marking	Pin 1 Orientation (See below)	Shipping <sup>†</sup>
NC7SV57P6X	SC-88	V57	Q4	3000 / Tape & Reel
NC7SV57L6X	MicroPak	H3	Q4	5000 / Tape & Reel
NC7SV57FHX	MicroPak2	H3	Q4	5000 / Tape & Reel
NC7SV57FHX-L22780	MicroPak2	H3	Q4	5000 / Tape & Reel
NC7SV58P6X	SC-88	V58	Q4	3000 / Tape & Reel
NC7SV58L6X	MicroPak	H4	Q4	5000 / Tape & Reel
NC7SV58FHX	MicroPak2	H4	Q4	5000 / Tape & Reel

<sup>†</sup>For information on tape and reel specifications, including part orientation and tape sizes, please refer to our Tape and Reel Packaging Specifications Brochure, BRD8011/D.

### Pin 1 Orientation in Tape and Reel

Direction of Feed

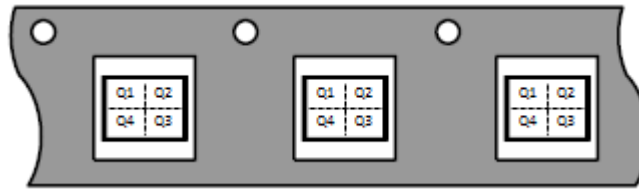

MicroPak and MicroPak2 are trademarks of Semiconductor Components Industries, LLC dba "onsemi" or its affiliates and/or subsidiaries in the United States and/or other countries.



**SIP6 1.45X1.0**  
CASE 127EB  
ISSUE O

DATE 31 AUG 2016

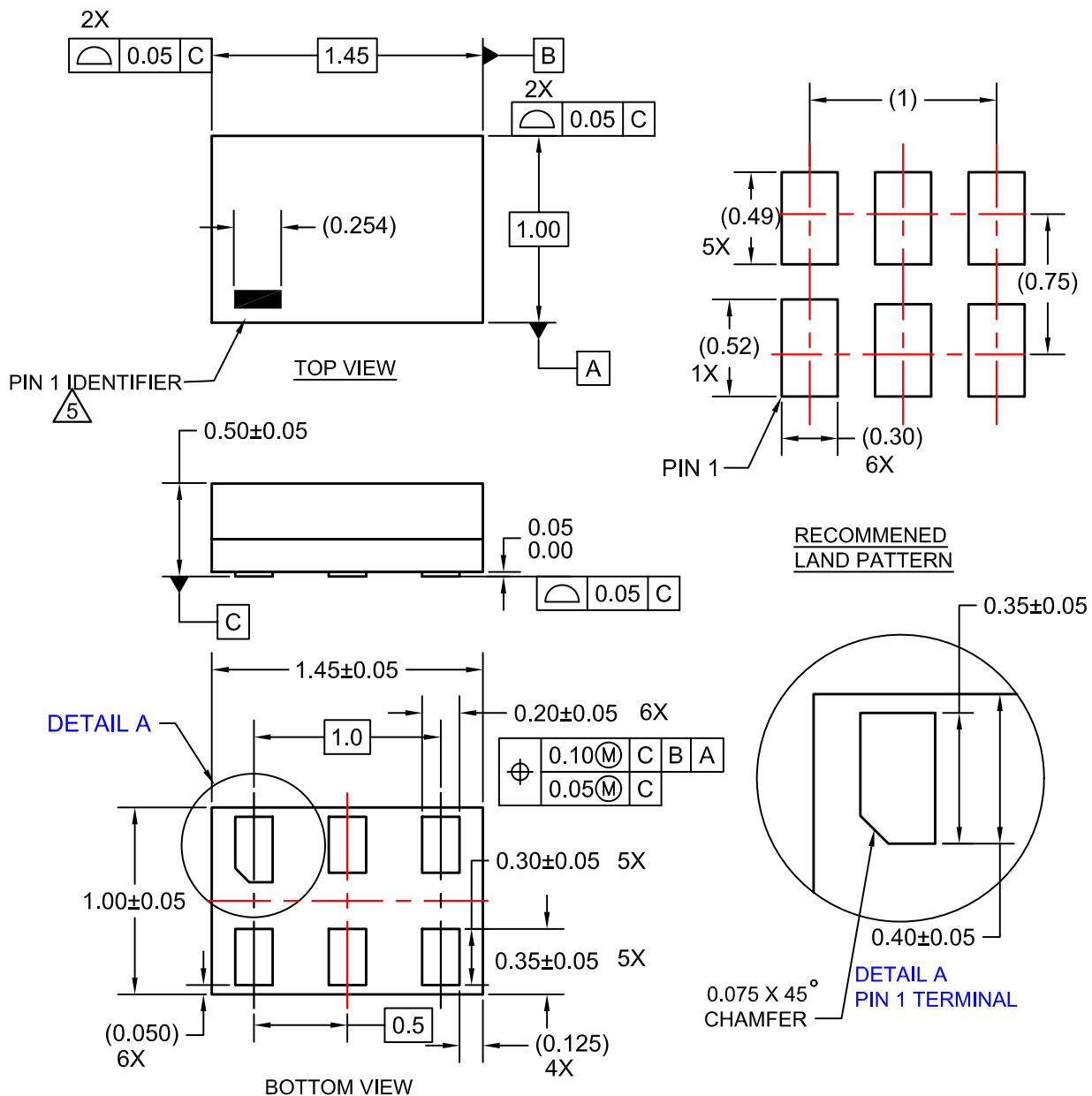

**NOTES:**

1. CONFORMS TO JEDEC STANDARD MO-252 VARIATION UAAD
2. DIMENSIONS ARE IN MILLIMETERS
3. DRAWING CONFORMS TO ASME Y14.5M-2009
4. PIN ONE IDENTIFIER IS 2X LENGTH OF ANY OTHER LINE IN THE MARK CODE LAYOUT.

<b>DOCUMENT NUMBER:</b>	<b>98AON13590G</b>	Electronic versions are uncontrolled except when accessed directly from the Document Repository. Printed versions are uncontrolled except when stamped "CONTROLLED COPY" in red.
<b>DESCRIPTION:</b>	<b>SIP6 1.45X1.0</b>	<b>PAGE 1 OF 1</b>

ON Semiconductor and are trademarks of Semiconductor Components Industries, LLC dba ON Semiconductor or its subsidiaries in the United States and/or other countries. ON Semiconductor reserves the right to make changes without further notice to any products herein. ON Semiconductor makes no warranty, representation or guarantee regarding the suitability of its products for any particular purpose, nor does ON Semiconductor assume any liability arising out of the application or use of any product or circuit, and specifically disclaims any and all liability, including without limitation special, consequential or incidental damages. ON Semiconductor does not convey any license under its patent rights nor the rights of others.

# MECHANICAL CASE OUTLINE

## PACKAGE DIMENSIONS

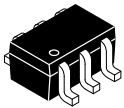

1

SC-88 (SC-70 6 Lead), 1.25x2  
CASE 419AD  
ISSUE A

DATE 07 JUL 2010



TOP VIEW

SYMBOL	MIN	NOM	MAX
A	0.80		1.10
A1	0.00		0.10
A2	0.80		1.00
b	0.15		0.30
c	0.10		0.18
D	1.80	2.00	2.20
E	1.80	2.10	2.40
E1	1.15	1.25	1.35
e	0.65 BSC		
L	0.26	0.36	0.46
L1	0.42 REF		
L2	0.15 BSC		
$\theta$	0°		8°
$\theta_1$	4°		10°

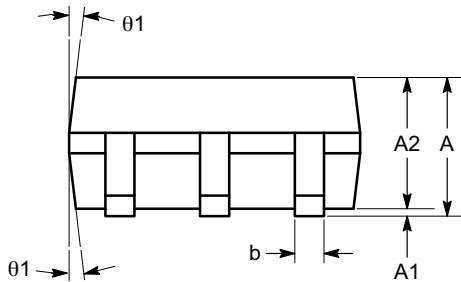

SIDE VIEW



END VIEW

**Notes:**

- (1) All dimensions are in millimeters. Angles in degrees.
- (2) Complies with JEDEC MO-203.

<b>DOCUMENT NUMBER:</b>	<b>98AON34266E</b>	Electronic versions are uncontrolled except when accessed directly from the Document Repository. Printed versions are uncontrolled except when stamped "CONTROLLED COPY" in red.
<b>DESCRIPTION:</b>	<b>SC-88 (SC-70 6 LEAD), 1.25X2</b>	<b>PAGE 1 OF 1</b>

onsemi and ONSEMI are trademarks of Semiconductor Components Industries, LLC dba onsemi or its subsidiaries in the United States and/or other countries. onsemi reserves the right to make changes without further notice to any products herein. onsemi makes no warranty, representation or guarantee regarding the suitability of its products for any particular purpose, nor does onsemi assume any liability arising out of the application or use of any product or circuit, and specifically disclaims any and all liability, including without limitation special, consequential or incidental damages. onsemi does not convey any license under its patent rights nor the rights of others.



**onsemi**, **Onsemi**, and other names, marks, and brands are registered and/or common law trademarks of Semiconductor Components Industries, LLC dba "**onsemi**" or its affiliates and/or subsidiaries in the United States and/or other countries. **onsemi** owns the rights to a number of patents, trademarks, copyrights, trade secrets, and other intellectual property. A listing of **onsemi**'s product/patent coverage may be accessed at [www.onsemi.com/site/pdf/Patent-Marking.pdf](http://www.onsemi.com/site/pdf/Patent-Marking.pdf). **onsemi** reserves the right to make changes at any time to any products or information herein, without notice. The information herein is provided "as-is" and **onsemi** makes no warranty, representation or guarantee regarding the accuracy of the information, product features, availability, functionality, or suitability of its products for any particular purpose, nor does **onsemi** assume any liability arising out of the application or use of any product or circuit, and specifically disclaims any and all liability, including without limitation special, consequential or incidental damages. Buyer is responsible for its products and applications using **onsemi** products, including compliance with all laws, regulations and safety requirements or standards, regardless of any support or applications information provided by **onsemi**. "Typical" parameters which may be provided in **onsemi** data sheets and/or specifications can and do vary in different applications and actual performance may vary over time. All operating parameters, including "Typicals" must be validated for each customer application by customer's technical experts. **onsemi** does not convey any license under any of its intellectual property rights nor the rights of others. **onsemi** products are not designed, intended, or authorized for use as a critical component in life support systems or any FDA Class 3 medical devices or medical devices with a same or similar classification in a foreign jurisdiction or any devices intended for implantation in the human body. Should Buyer purchase or use **onsemi** products for any such unintended or unauthorized application, Buyer shall indemnify and hold **onsemi** and its officers, employees, subsidiaries, affiliates, and distributors harmless against all claims, costs, damages, and expenses, and reasonable attorney fees arising out of, directly or indirectly, any claim of personal injury or death associated with such unintended or unauthorized use, even if such claim alleges that **onsemi** was negligent regarding the design or manufacture of the part. **onsemi** is an Equal Opportunity/Affirmative Action Employer. This literature is subject to all applicable copyright laws and is not for resale in any manner.

---

## ADDITIONAL INFORMATION

### TECHNICAL PUBLICATIONS:

Technical Library: [www.onsemi.com/design/resources/technical-documentation](http://www.onsemi.com/design/resources/technical-documentation)  
onsemi Website: [www.onsemi.com](http://www.onsemi.com)

### ONLINE SUPPORT: [www.onsemi.com/support](http://www.onsemi.com/support)

For additional information, please contact your local Sales Representative at [www.onsemi.com/support/sales](http://www.onsemi.com/support/sales)