

NCN1154

DP3T Data Switch, USB 2.0 High Speed / Audio, with Negative Swing Capability

The NCN1154 is a DP3T switch for combined true-ground audio, USB 2.0 high speed data, and UART applications. It allows portable systems to use a single port to pass either high speed data or audio signals from an external headset; the 3 channels being compliant to USB 2.0, USB 1.1 and USB 1.0.

The switch is capable of passing signals with negative voltages as low as 2 V below ground. The device features shunt resistors on the audio ports. These resistors are switched in when the audio channel is off and provide a safe path to ground for any charge that may build up on the audio lines. This reduces Pop & Click noise in the audio system.

The NCN1154 is housed in a space-saving, ultra low profile 2.0x1.7x0.5mm, 12 pin UQFN package.

Features

- 3:1 High Speed Switch
- USB 2.0, USB 1.1 & USB 1.0 Capable on all Channels
- High Bandwidth of 820 MHz on D+/D-
- Capable of Passing Negative Swing Signals Down to -2 V on R/L Channel
- 1.8 V Compatible Control Pins for $2.7\text{ V} \leq V_{CC} \leq 4.2\text{ V}$
- Audio Channel Shunt Resistors for Pop & Click Noise Reduction
- Ultra Low THD in Audio Mode: 0.01% into 16 Ω Load
- 5.25 V Tolerant Common Pins
- This is a Pb-Free Device

Typical Applications

- Micro or Mini USB Applications
- Shared High Speed Data or Audio on a Single Connector
- Mobile Phones
- Tablets
- Bar Code Scanners
- Portable Devices



ON Semiconductor®

www.onsemi.com

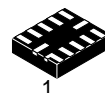

UQFN12
MU SUFFIX
CASE 523AE

MARKING DIAGRAM

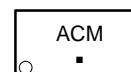

AC = Specific Device Code
M = Date Code
■ = Pb-Free Package

APPLICATION DIAGRAM

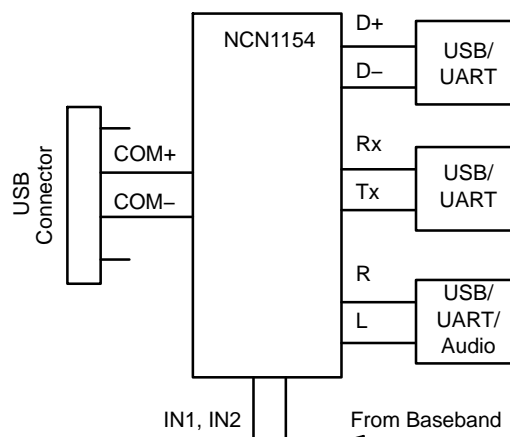

ORDERING INFORMATION

Device	Package	Shipping†
NCN1154MUTAG	UQFN12 (Pb-Free)	3000 / Tape & Reel

†For information on tape and reel specifications, including part orientation and tape sizes, please refer to our Tape and Reel Packaging Specification Brochure, BRD8011/D.

NCN1154

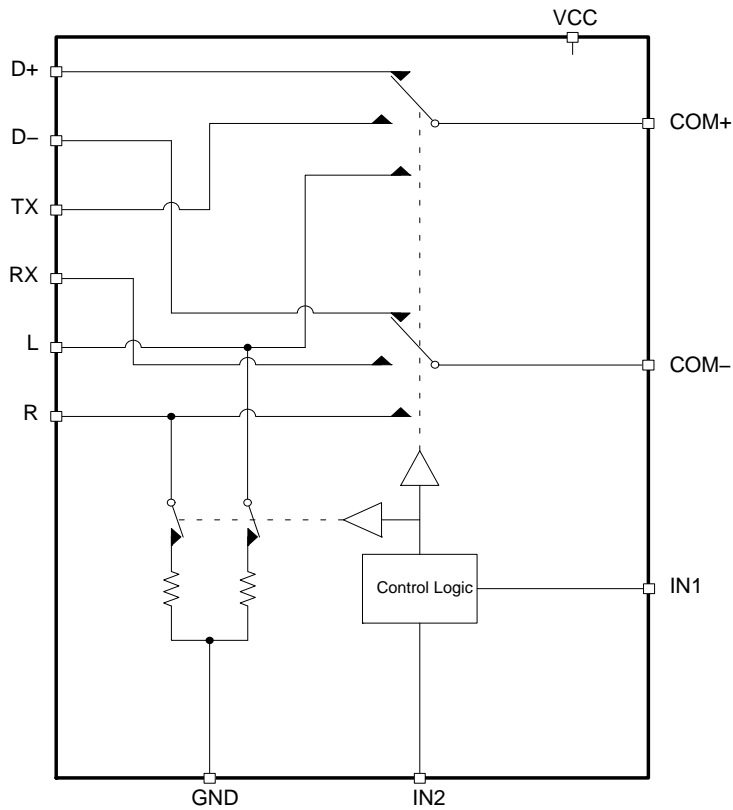

Figure 1. Functional Block Diagram

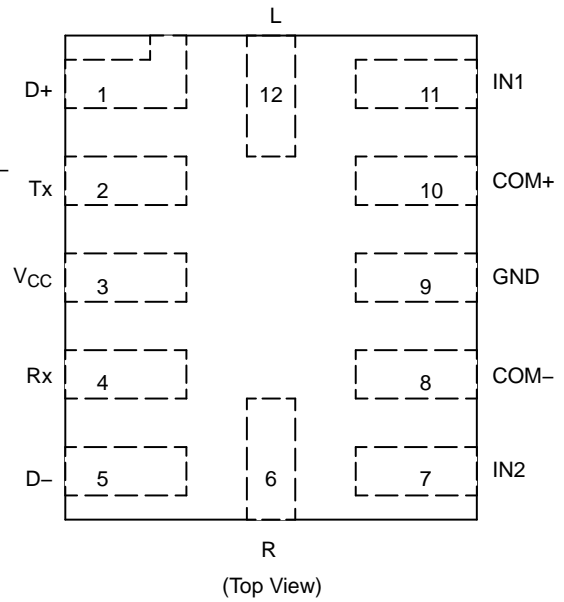

Figure 2. Pinout Diagram

PIN DESCRIPTIONS

Pin #	Name	Direction	Description
1	D+	I/O	Positive Data Line for USB Signals
2	Tx	I/O	Transmit Data Line for UART Signals
3	V _{CC}	Power	Power Supply
4	Rx	I/O	Receive Data Line for UART Signals
5	D-	I/O	Negative Data Line for USB Signals
6	R	I/O	Right Line for Audio Signals
7	IN2	Input	Control Input Select Line
8	COM-	I/O	Right Audio / Negative Data Common Line
9	GND	Power	Ground
10	COM+	I/O	Left Audio / Positive Data Common Line
11	IN1	Input	Control Input Select Line
12	L	I/O	Left Line for Audio Signals

TRUTH TABLE

IN1	IN2	D+, D-	R _X /T _X	L, R	L, R SHUNT
0	0	Hi Z	Hi Z	Hi Z	ON
0	1	ON	Hi Z	Hi Z	ON
1	0	Hi Z	Hi Z	ON	OFF
1	1	Hi Z	ON	Hi Z	ON

NCN1154

OPERATING CONDITIONS

MAXIMUM RATINGS

Symbol	Pins	Parameter	Value	Unit
V _{CC}	V _{CC}	Positive DC Supply Voltage	-0.5 to +6.0	V
V _{IS}	R, L, D+, D-, Rx, Tx	Analog I/O	-2.5 to V _{CC} + 0.5	V
	COM+, COM-		-2.5 to +6.0	
V _{IN}	IN1, IN2	Control Input Voltage	-0.5 to +6.0	V
I _{CC}	V _{CC}	Positive DC Supply Current	50	mA
T _S		Storage Temperature	-65 to +150	°C
I _{IS_CON}	COM+, COM-, R, L, D+, D-, Rx, Tx	Analog Signal Continuous Current-Closed Switch	± 100	mA
I _{IS_PK}	COM+, COM-, R, L, D+, D-, Rx, Tx	Analog Signal Continuous Current 10% Duty Cycle	± 500	mA
I _{IN}	IN1, IN2	Control Input Current	1.0	mA

Stresses exceeding those listed in the Maximum Ratings table may damage the device. If any of these limits are exceeded, device functionality should not be assumed, damage may occur and reliability may be affected.

NOTE: These devices have limited built-in ESD protection. The leads should be shorted together or the device placed in conductive foam during storage or handling to prevent electrostatic damage.

RECOMMENDED OPERATING CONDITIONS

Symbol	Pins	Parameter	Min	Max	Unit
V _{CC}	V _{CC}	Positive DC Supply Voltage	2.7	5.0	V
V _{IS}	D+ to COM+, D- to COM-	Analog Signal Voltage (Note 1)	GND	V _{CC}	V
	L to COM+, R to COM-		-2.0	V _{CC}	
	Tx to COM+, Rx to COM-		GND	V _{CC}	
V _{IN}	IN1, IN2	Control Input Voltage	GND	V _{CC}	V
T _A		Operating Temperature	-40	+85	°C

Functional operation above the stresses listed in the Recommended Operating Ranges is not implied. Extended exposure to stresses beyond the Recommended Operating Ranges limits may affect device reliability.

1. In USB mode, any signal supplied to the off-state audio inputs R, L may not swing below ground or above 1.5 V.

DC ELECTRICAL CHARACTERISTICS

CONTROL INPUT Min and Max apply for T_A between -40°C to +85°C and T_J up to +125°C (Unless otherwise noted). Typical values are referenced to T_A = +25°C, V_{CC} = 3.3 V.

Symbol	Pins	Parameter	Test Conditions	V _{CC} (V)	-40°C to +85°C			Unit
					Min	Typ	Max	
V _{IH}	IN1, IN2	Control Input HIGH Voltage		2.7	1.3	-	-	V
				3.3	1.4			
				4.2	1.5			
V _{IL}	IN1, IN2	Control Input LOW Voltage		2.7	-	-	0.4	V
				3.3			0.4	
				4.2			0.4	
I _{IN}	IN1, IN2	Current Input Leakage Current	0 ≤ V _{IS} ≤ V _{CC}		-	-	±50	nA

NCN1154

SUPPLY CURRENT AND LEAKAGE Min and Max apply for T_A between -40°C to $+85^{\circ}\text{C}$ and T_J up to $+125^{\circ}\text{C}$ (Unless otherwise noted). Typical values are referenced to $T_A = +25^{\circ}\text{C}$, $V_{CC} = 3.3\text{ V}$.

Symbol	Pins	Parameter	Test Conditions	V_{CC} (V)	-40°C to $+85^{\circ}\text{C}$			Unit
					Min	Typ	Max	
$I_{NC,NO(OFF)}$	D+, D- R, L Tx, Rx	OFF State Leakage	$V_{COM-}, V_{COM+} = 0\text{ V}, 4.2\text{ V}$ $V_{D+}, V_{D-} = 4.2\text{ V}, 0\text{ V}$ or float $V_L, V_R = \text{float or } 4.2\text{ V}, 0\text{ V}$	4.2			± 80	nA
$I_{COM(ON)}$	COM-, COM+	ON State Leakage	$V_{COM-}, V_{COM+} = 0\text{ V}, 4.2\text{ V}$ $V_{D+}, V_{D-} = 4.2\text{ V}, 0\text{ V}$ or float $V_L, V_R = \text{float or } 4.2\text{ V}, 0\text{ V}$	4.2			± 100	nA
I_{CC}	V_{CC}	Quiescent Supply	$V_{IS} = \text{GND to } V_{CC}; I_D = 0\text{ A}$	4.2		21	35	μA
I_{OFF}	COM-, COM+	Power OFF Leakage	$0 \leq V_{IS} \leq 5.0\text{ V}$	0			50	μA

USB ON RESISTANCE Min and Max apply for T_A between -40°C to $+85^{\circ}\text{C}$ and T_J up to $+125^{\circ}\text{C}$ (Unless otherwise noted). Typical values are referenced to $T_A = +25^{\circ}\text{C}$, $V_{CC} = 3.3\text{ V}$.

Symbol	Pins	Parameter	Test Conditions	V_{CC} (V)	-40°C to $+85^{\circ}\text{C}$			Unit
					Min	Typ	Max	
R_{ON}	D+ to COM+ D- to COM-	On-Resistance	$I_{ON} = 10\text{ mA}$ $V_{IS} = 0\text{ V to } V_{CC}$	2.7		5.5	7.5	Ω
				3.3		5.5	7.5	
				4.2		5.5	7.5	
R_{FLAT}	D+ to COM+ D- to COM-	On-Resistance Flatness	$I_{ON} = 10\text{ mA}$ $V_{IS} = 0\text{ V to } V_{CC}$	2.7		0.08		Ω
				3.3		0.08		
				4.2		0.08		
ΔR_{ON}	D+ to COM+ D- to COM-	On-Resistance Matching	$I_{ON} = 10\text{ mA}$ $V_{IS} = 0\text{ V to } V_{CC}$	2.7		0.03		Ω
				3.3		0.03		
				4.2		0.03		

AUDIO ON RESISTANCE Min and Max apply for T_A between -40°C to $+85^{\circ}\text{C}$ and T_J up to $+125^{\circ}\text{C}$ (Unless otherwise noted). Typical values are referenced to $T_A = +25^{\circ}\text{C}$, $V_{CC} = 3.3\text{ V}$.

Symbol	Pins	Parameter	Test Conditions	V_{CC} (V)	-40°C to $+85^{\circ}\text{C}$			Unit
					Min	Typ	Max	
R_{ON}	R to COM+ L to COM-	On-Resistance	$I_{ON} = 10\text{ mA}$ $V_{IS} = -1.5\text{ to } 1.5$	2.7		3.0	4.7	Ω
				3.3		3.0	4.7	
				4.2		3.0	4.7	
R_{FLAT}	R to COM+ L to COM-	On-Resistance Flatness	$I_{ON} = 10\text{ mA}$ $V_{IS} = -1.5\text{ to } 1.5$	2.7		0.11		Ω
				3.3		0.11		
				4.2		0.11		
ΔR_{ON}	R to COM+ L to COM-	On-Resistance Matching	$I_{ON} = 10\text{ mA}$ $V_{IS} = -1.5\text{ to } 1.5$	2.7		0.03		Ω
				3.3		0.03		
				4.2		0.03		
R_{SH}	L, R	Shunt Resistance (Resistor + Switch)	$I_{ON} = 10\text{ mA}$	2.7 – 4.2		118	160	Ω

UART ON RESISTANCE Min and Max apply for T_A between -40°C to $+85^{\circ}\text{C}$ and T_J up to $+125^{\circ}\text{C}$ (Unless otherwise noted). Typical values are referenced to $T_A = +25^{\circ}\text{C}$, $V_{CC} = 3.3\text{ V}$.

Symbol	Pins	Parameter	Test Conditions	V_{CC} (V)	-40°C to $+85^{\circ}\text{C}$			Unit
					Min	Typ	Max	
R_{ON}	Tx to COM+ Rx to COM-	On-Resistance	$I_{ON} = 10\text{ mA}$ $V_{IS} = 0\text{ V to } V_{CC}$	2.7		5.5	7.5	Ω
				3.3		5.5	7.5	
				4.2		5.5	7.5	
R_{FLAT}	Tx to COM+ Rx to COM-	On-Resistance Flatness	$I_{ON} = 10\text{ mA}$ $V_{IS} = 0\text{ V to } V_{CC}$	2.7		0.08		Ω
				3.3		0.08		
				4.2		0.08		
ΔR_{ON}	Tx to COM+ Rx to COM-	On-Resistance Matching	$I_{ON} = 10\text{ mA}$ $V_{IS} = 0\text{ V to } V_{CC}$	2.7		0.03		Ω
				3.3		0.03		
				4.2		0.03		

Product parametric performance is indicated in the Electrical Characteristics for the listed test conditions, unless otherwise noted. Product performance may not be indicated by the Electrical Characteristics if operated under different conditions.

AC ELECTRICAL CHARACTERISTICS

TIMING/FREQUENCY Min and Max apply for T_A between -40°C to $+85^{\circ}\text{C}$ and T_J up to $+125^{\circ}\text{C}$ (Unless otherwise noted). Typical values are referenced to $T_A = +25^{\circ}\text{C}$, $V_{CC} = 3.3\text{ V}$. $R_L = 50\ \Omega$, $C_L = 35\ \text{pF}$, $f = 1\ \text{MHz}$.

Symbol	Pins	Parameter	Test Conditions	V_{CC} (V)	-40°C to $+85^{\circ}\text{C}$			Unit
					Min	Typ	Max	
t_{ON}		Turn-ON Time (Closed to Open)				15		μs
t_{OFF}		Turn-OFF Time (Closed to Open)				67		ns
T_{BBM}		Break-Before-Make Time				11		μs
BW	D+ / D- Tx / Rx R / L	-3 dB Bandwidth	$C_L = 5\ \text{pF}$ $R_S = 50\ \Omega$			820 800 750		MHz

ISOLATION Min and Max apply for T_A between -40°C to $+85^{\circ}\text{C}$ and T_J up to $+125^{\circ}\text{C}$ (Unless otherwise noted). Typical values are referenced to $T_A = +25^{\circ}\text{C}$, $V_{CC} = 3.3\text{ V}$. $R_L = 50\ \Omega$, $C_L = 5\ \text{pF}$.

Symbol	Pins	Parameter	Test Conditions	V_{CC} (V)	-40°C to $+85^{\circ}\text{C}$			Unit
					Min	Typ	Max	
O_{IRR}	Open	OFF-Isolation	$f = 100\ \text{kHz}$, $R_S = 50\ \Omega$			-81		dB
X_{TALK}	COM+ to COM-	Non-Adjacent Channel Crosstalk	$f = 100\ \text{kHz}$, $R_S = 50\ \Omega$			-93		dB
THD+N		Total Harmonic Distortion + Noise	IN1, IN2 = 3.0 V $f = 20\ \text{Hz}$ to $20\ \text{kHz}$ $V_{COM} = 0.5\ V_{pp}$ $R_L = 600\ \Omega$	3.0		0.001		%
PSRR		Power Supply Rejection Ratio	$f = 10\ \text{kHz}$ $R_{COM} = 50\ \Omega$	3.0		60		dB

CAPACITANCE Min and Max apply for T_A between -40°C to $+85^{\circ}\text{C}$ and T_J up to $+125^{\circ}\text{C}$ (Unless otherwise noted). Typical values are referenced to $T_A = +25^{\circ}\text{C}$, $V_{CC} = 3.3\text{ V}$. $R_L = 50\ \Omega$, $C_L = 5\ \text{pF}$, $f = 1\ \text{MHz}$.

Symbol	Pins	Parameter	Test Conditions	-40°C to $+85^{\circ}\text{C}$			Unit
				Min	Typ	Max	
C_{IN}	IN1, IN2	Control Pin Input Capacitance	$V_{CC} = 0\ \text{V}$		2.0		pF
C_{ON}	D+, Tx to COM+ D-, Rx to COM-	USB, UART ON Capacitance			9.0		pF
C_{ON}	R to COM+ L to COM-	Audio ON Capacitance			8.5		pF
C_{OFF}	D+, D- Tx, Rx	USB, UART OFF Capacitance			3.5		pF

TABLE OF GRAPHS

Symbol	Parameter	Figure
NE	Near End Signaling Eye Diagram	3, 4, 5, 6
FE	Far End Signaling Eye Diagram	7, 8, 9, 10
BW	Frequency Response	11, 12, 13

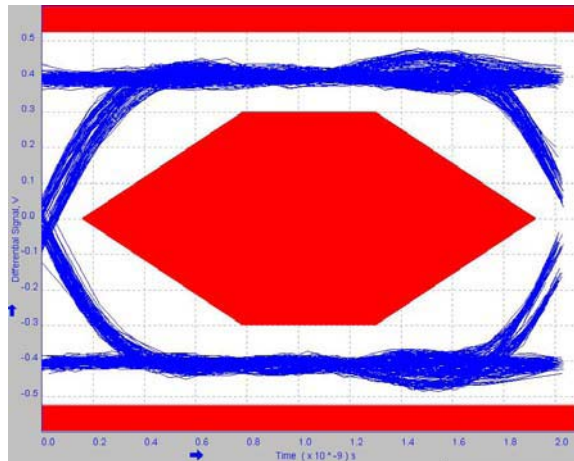

Figure 3. Reference Near End Eye Diagram (Path Trough Dedicated Line, Temp = 25°C)

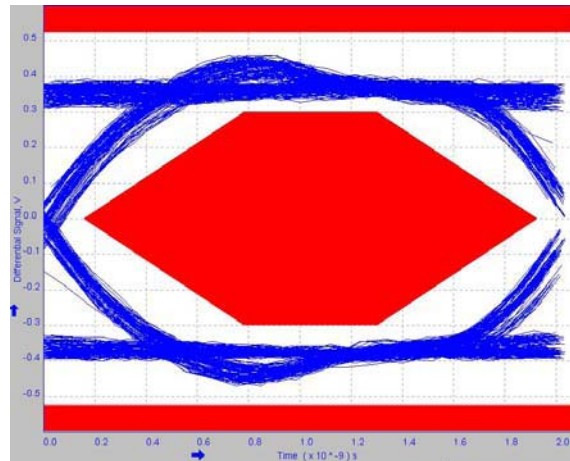

Figure 4. USB Switch Near End Eye Diagram (V_{CC} = 3.6 V, IN1 = 0, IN2 = 1, Temp = 25°C)

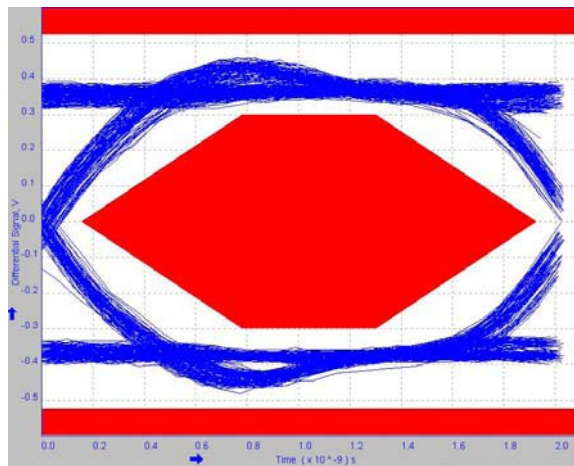

Figure 5. UART Switch Near End Eye Diagram (V_{CC} = 3.6 V, IN1 = 1, IN2 = 1, Temp = 25°C)

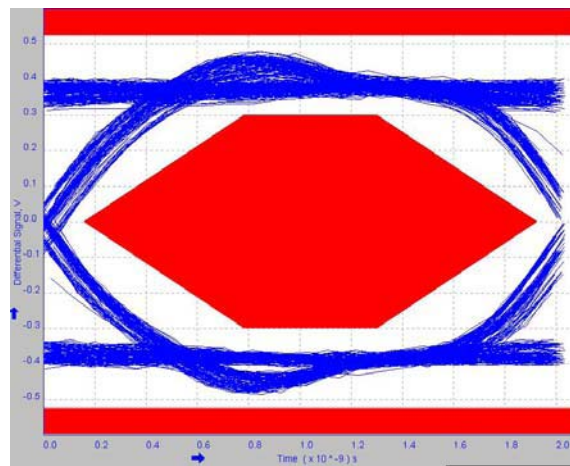

Figure 6. Audio Switch Near End Eye Diagram (V_{CC} = 3.6 V, IN1 = 1, IN2 = 0, Temp = 25°C)

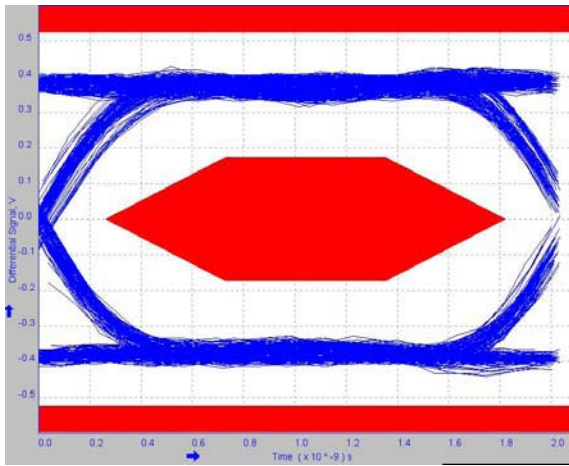

Figure 7. Reference Far End Eye Diagram
(Path Trough Dedicated Line, Temp = 25°C)

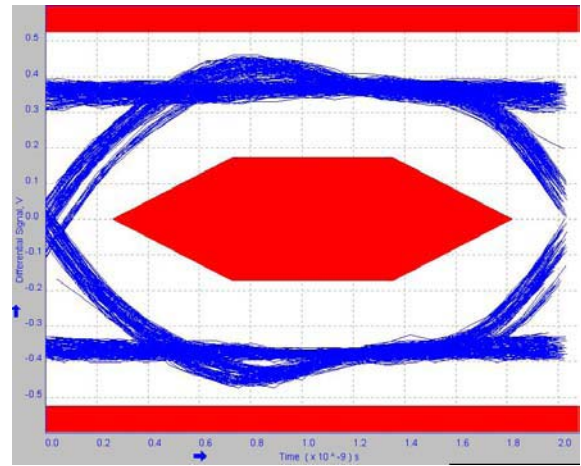

Figure 8. USB Switch Far End Eye Diagram
(V_{CC} = 3.6V, IN1 = 0, IN2 = 1, Temp = 25°C)

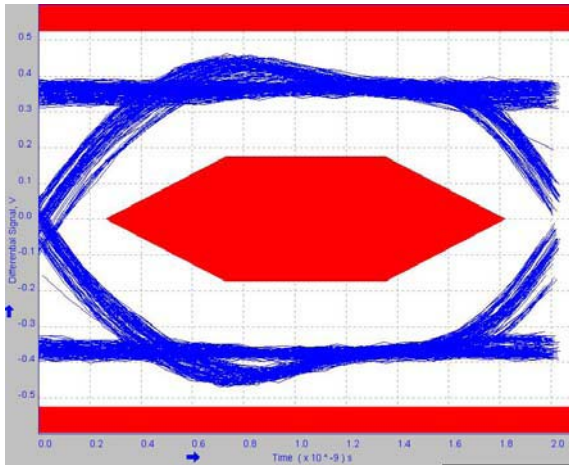

Figure 9. UART Switch Far End Eye Diagram
(V_{CC} = 3.6 V, IN1 = 1, IN2 = 1, Temp = 25°C)

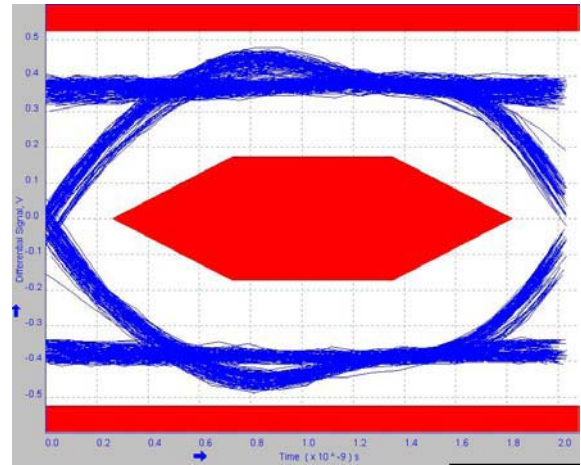

Figure 10. Audio Switch Far End Eye Diagram
(V_{CC} = 3.6 V, IN1 = 1, IN2 = 0, Temp = 25°C)

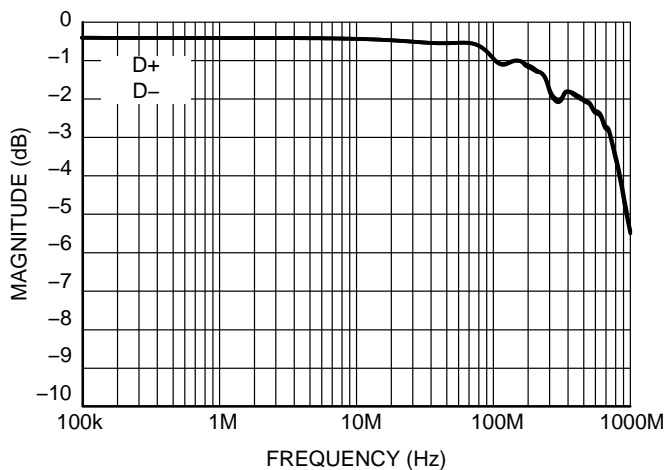

Figure 11. USB Path Frequency Response

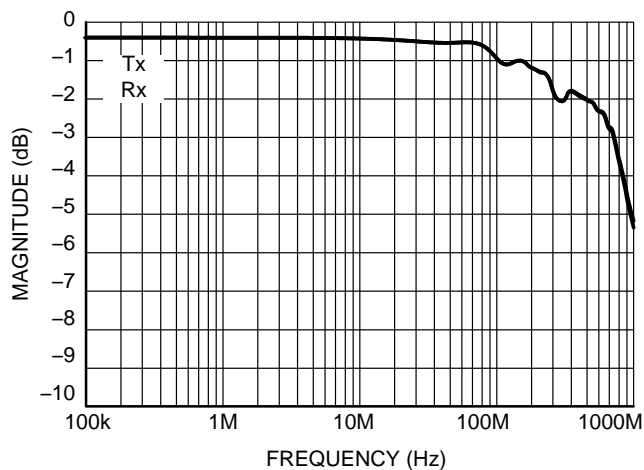

Figure 12. UART Path Frequency Response

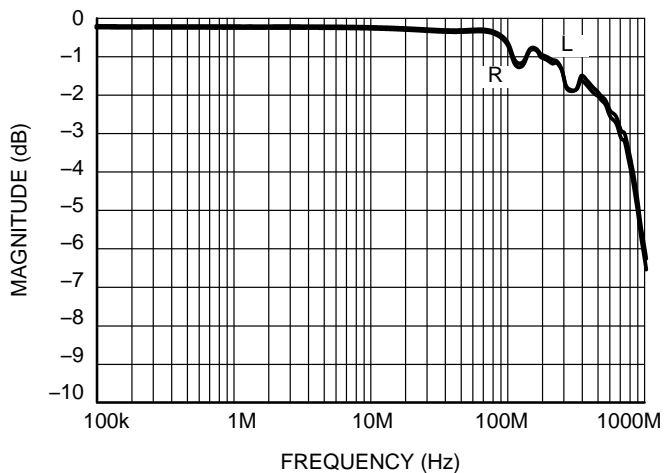

Figure 13. Audio Path Frequency Response

MECHANICAL CASE OUTLINE PACKAGE DIMENSIONS

ON Semiconductor®



UQFN12 1.7x2.0, 0.4P CASE 523AE-01 ISSUE A

DATE 11 JUN 2007

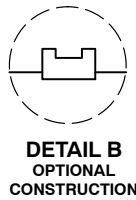
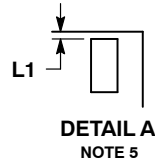
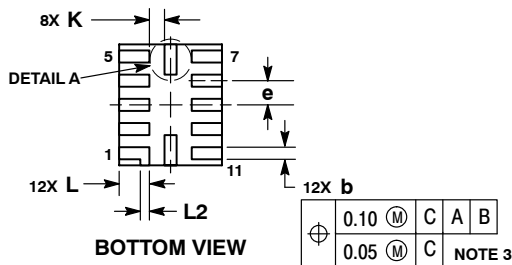
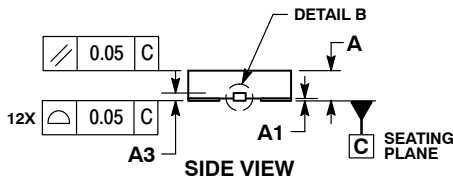
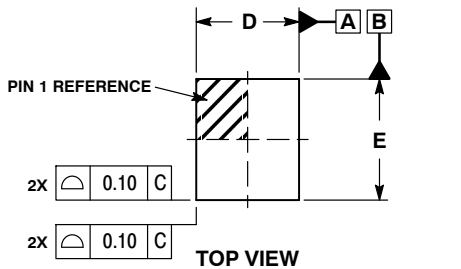
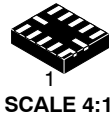

NOTES:

1. DIMENSIONING AND TOLERANCING PER ASME Y14.5M, 1994.
2. CONTROLLING DIMENSION: MILLIMETERS
3. DIMENSION b APPLIES TO PLATED TERMINAL AND IS MEASURED BETWEEN 0.15 AND 0.30 MM FROM TERMINAL TIP.
4. MOLD FLASH ALLOWED ON TERMINALS ALONG EDGE OF PACKAGE. FLASH 0.03 MAX ON BOTTOM SURFACE OF TERMINALS.
5. DETAIL A SHOWS OPTIONAL CONSTRUCTION FOR TERMINALS.

DIM	MILLIMETERS	
	MIN	MAX
A	0.45	0.55
A1	0.00	0.05
A3	0.127 REF	
b	0.15	0.25
D	1.70 BSC	
E	2.00 BSC	
e	0.40 BSC	
K	0.20	---
L	0.45	0.55
L1	0.00	0.03
L2	0.15 REF	

GENERIC MARKING DIAGRAM*

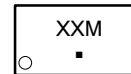

- XX = Specific Device Code
- M = Date Code
- = Pb-Free Package

*This information is generic. Please refer to device data sheet for actual part marking. Pb-Free indicator, "G" or microdot "•", may or may not be present.

MOUNTING FOOTPRINT SOLDERMASK DEFINED

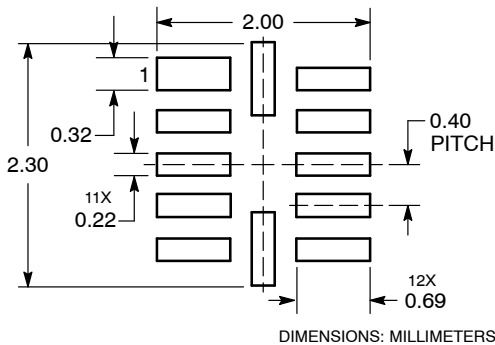

DOCUMENT NUMBER:	98AON23418D	Electronic versions are uncontrolled except when accessed directly from the Document Repository. Printed versions are uncontrolled except when stamped "CONTROLLED COPY" in red.
DESCRIPTION:	UQFN12 1.7 X 2.0, 0.4P	PAGE 1 OF 1

ON Semiconductor and ON are trademarks of Semiconductor Components Industries, LLC dba ON Semiconductor or its subsidiaries in the United States and/or other countries. ON Semiconductor reserves the right to make changes without further notice to any products herein. ON Semiconductor makes no warranty, representation or guarantee regarding the suitability of its products for any particular purpose, nor does ON Semiconductor assume any liability arising out of the application or use of any product or circuit, and specifically disclaims any and all liability, including without limitation special, consequential or incidental damages. ON Semiconductor does not convey any license under its patent rights nor the rights of others.

onsemi, **Onsemi**, and other names, marks, and brands are registered and/or common law trademarks of Semiconductor Components Industries, LLC dba "**onsemi**" or its affiliates and/or subsidiaries in the United States and/or other countries. **onsemi** owns the rights to a number of patents, trademarks, copyrights, trade secrets, and other intellectual property. A listing of **onsemi**'s product/patent coverage may be accessed at www.onsemi.com/site/pdf/Patent-Marking.pdf. **onsemi** reserves the right to make changes at any time to any products or information herein, without notice. The information herein is provided "as-is" and **onsemi** makes no warranty, representation or guarantee regarding the accuracy of the information, product features, availability, functionality, or suitability of its products for any particular purpose, nor does **onsemi** assume any liability arising out of the application or use of any product or circuit, and specifically disclaims any and all liability, including without limitation special, consequential or incidental damages. Buyer is responsible for its products and applications using **onsemi** products, including compliance with all laws, regulations and safety requirements or standards, regardless of any support or applications information provided by **onsemi**. "Typical" parameters which may be provided in **onsemi** data sheets and/or specifications can and do vary in different applications and actual performance may vary over time. All operating parameters, including "Typicals" must be validated for each customer application by customer's technical experts. **onsemi** does not convey any license under any of its intellectual property rights nor the rights of others. **onsemi** products are not designed, intended, or authorized for use as a critical component in life support systems or any FDA Class 3 medical devices or medical devices with a same or similar classification in a foreign jurisdiction or any devices intended for implantation in the human body. Should Buyer purchase or use **onsemi** products for any such unintended or unauthorized application, Buyer shall indemnify and hold **onsemi** and its officers, employees, subsidiaries, affiliates, and distributors harmless against all claims, costs, damages, and expenses, and reasonable attorney fees arising out of, directly or indirectly, any claim of personal injury or death associated with such unintended or unauthorized use, even if such claim alleges that **onsemi** was negligent regarding the design or manufacture of the part. **onsemi** is an Equal Opportunity/Affirmative Action Employer. This literature is subject to all applicable copyright laws and is not for resale in any manner.

ADDITIONAL INFORMATION

TECHNICAL PUBLICATIONS:

Technical Library: www.onsemi.com/design/resources/technical-documentation
onsemi Website: www.onsemi.com

ONLINE SUPPORT: www.onsemi.com/support

For additional information, please contact your local Sales Representative at www.onsemi.com/support/sales