

# Voltage Regulators, 1.0 A Low-Dropout Positive, Fixed and Adjustable

## NCP1117LP

The NCP1117LP is the low power version of the popular NCP1117 family of low dropout voltage regulators, with reduced quiescent current. It is intended primarily for high volume consumer applications over the 0 to 125 degree temperature range. Capable of providing an output current in excess of 1 A, with a dropout voltage of 1.3 V at 1 A full current load, the series consists of an adjustable and five fixed voltage versions of 1.5 V, 1.8 V, 2.5 V, 3.3 V and 5.0 V.

Internal protection features consist of output current limiting and built-in thermal shutdown. The NCP1117LP series can operate up to 18 V max input voltage. The device is available in the popular SOT-223 and DPAK packages.

### Features

- Output Current in Excess of 1.0 A
- 1.4 V Maximum Dropout Voltage at 1 A
- Quiescent Current over 10 times Lower than Traditional 1117
- Fixed Output Voltages of 1.5 V, 1.8 V, 2.5 V, 3.3 V and 5.0 V
- Adjustable Output Voltage Option
- No Minimum Load Requirement for Fixed Voltage Output Devices
- Good Noise Rejection
- Current Limit and Thermal Shutdown Protection
- Operation up to 18 V Input
- These are Pb-Free Devices

### Applications

- TV and Monitors
- Set Top Boxes and Entertainment Devices
- Switching Power Supply Post Regulation
- Game Consoles and Consumer Applications
- Hard Drive Controllers

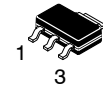

SOT-223  
ST SUFFIX  
CASE 318H

Pin: 1. Adjust/Ground  
2. Output  
3. Input

### MARKING DIAGRAM

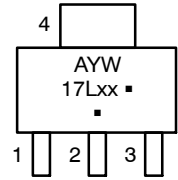

Heatsink tab is connected to Pin 2.

- xx = 15, 18, 25, 33, 50, AD
- A = Assembly Location
- Y = Year
- W = Work Week
- = Pb-Free Package

(Note: Microdot may be in either location)

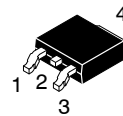

DPAK  
DT SUFFIX  
CASE 369C

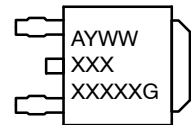

### ORDERING INFORMATION

See detailed ordering and shipping information on page 12 of this data sheet.

### TYPICAL APPLICATIONS

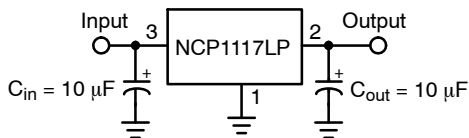

Figure 1. Fixed Output Regulator

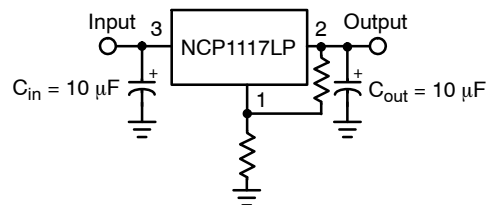

Figure 2. Adjustable Output Regulator

# NCP1117LP

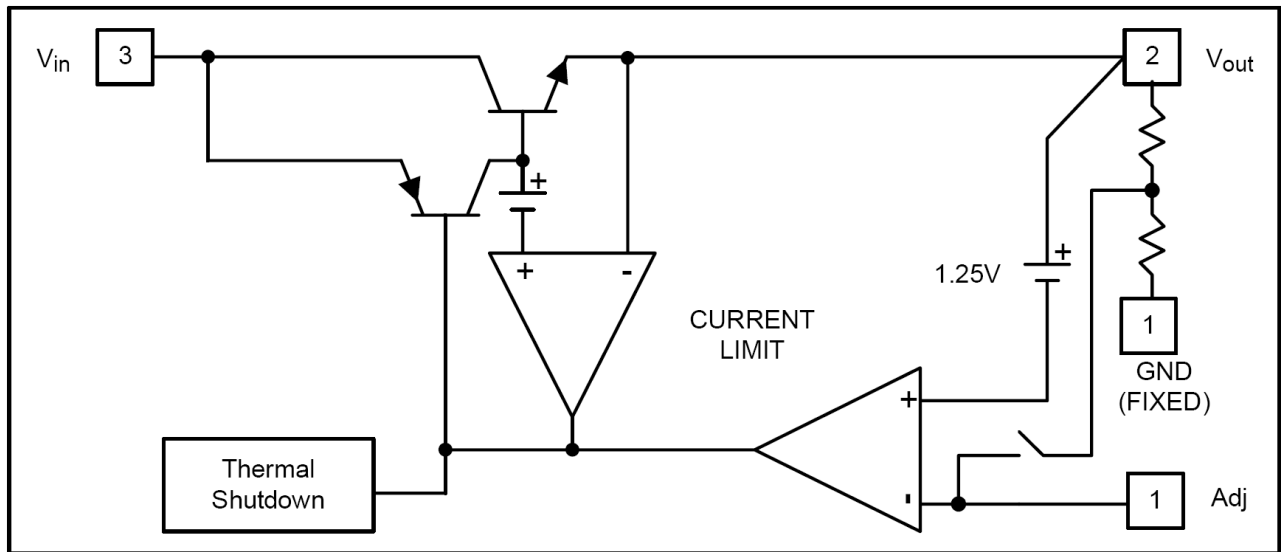

Figure 3. Block Diagram

Table 1. PIN FUNCTION DESCRIPTION

Pin No.	Pin Name	Description
1	Adj (GND)	A resistor divider from this pin to the Vout pin and ground sets the output voltage (Ground only for Fixed-Mode).
2	Vout	The output of the regulator. A minimum of 10 $\mu$ F capacitor ( $20 \text{ m}\Omega \leq \text{ESR} \leq 20 \Omega$ ) must be connected from this pin to ground to insure stability.
3	Vin	The input pin of regulator. Typically a large storage capacitor ( $20 \text{ m}\Omega \leq \text{ESR} \leq 20 \Omega$ ) is connected from this pin to ground to insure that the input voltage does not sag below the minimum dropout voltage during the load transient response. This pin must always be 1.3 V (typ.) higher than Vout in order for the device to regulate properly.

Table 2. MAXIMUM RATINGS

Rating	Symbol	Value	Unit
DC Input Voltage	$V_{in}$	-0.3 to 18	V
Operating Junction Temperature Range	$T_{OP}$	0 to 125	$^{\circ}\text{C}$
Operating Ambient Temperature Range	$T_A$	0 to 125	$^{\circ}\text{C}$
Maximum Junction Temperature Range	$T_{J(max)}$	-55 to 150	$^{\circ}\text{C}$
Power Dissipation and Thermal Characteristics - Power Dissipation (Note 1) - Thermal Resistance, Junction-to-Ambient (Note 2) - Thermal Resistance, Junction-to-Case	$P_D$ $R_{\theta JA}$ $R_{\theta JC}$	Internally Limited 108 15	W $^{\circ}\text{C}/\text{W}$ $^{\circ}\text{C}/\text{W}$
Electrostatic Discharge	Human Body Model	ESD	2000
	Machine Model		200
Storage Temperature Range	$T_{STG}$	-65 to 150	$^{\circ}\text{C}$
NOTE: This device series contains ESD protection and exceeds the following tests: ESD HBM tested per AEC-Q100-002 (EIA/JESD22-A114) ESD MM tested per AEC-Q100-003 (EIA/JESD22-A115) Latch-up Current Maximum Rating: $\leq 150 \text{ mA}$ per JEDEC standard: JESD78			

Stresses exceeding those listed in the Maximum Ratings table may damage the device. If any of these limits are exceeded, device functionality should not be assumed, damage may occur and reliability may be affected.

NOTE: All voltages are referenced to GND pin.

1. The maximum package power dissipation is:

$$P_D = \frac{T_{J(max)} - T_A}{R_{\theta JA}}$$

2.  $R_{\theta JA}$  on a 100 x 100 mm PCB Cu thickness 1 oz;  $T_A = 25^{\circ}\text{C}$

# NCP1117LP

**Table 3. ELECTRICAL CHARACTERISTICS** ( $C_{in} = 10 \mu F$ ,  $C_{out} = 10 \mu F$ , for typical value  $T_A = 25^\circ C$ , for min and max values  $T_A$  is the operating ambient temperature range that applies unless otherwise noted.)

Parameter	Conditions		Symbol	Min	Typ	Max	Unit
Reference Voltage, Adjustable Output Devices	NCP1117-ADJ	$T_J = 25^\circ C$ $(V_{in} - V_{out}) = 1.5 V, I_o = 10 mA$	$V_{ref}$	1.225	1.250	1.275	V
Output Voltage, Fixed Output Devices	NCP1117-1.5	$T_J = 25^\circ C$ $3 V \leq V_{in} \leq 12 V, I_o = 10 mA$	$V_{out}$	1.470	1.5	1.530	V
	NCP1117-1.8	$T_J = 25^\circ C$ $3.3 V \leq V_{in} \leq 12 V, I_o = 10 mA$		1.760	1.8	1.840	V
	NCP1117-2.5	$T_J = 25^\circ C$ $4 V \leq V_{in} \leq 12 V, I_o = 10 mA$		2.450	2.5	2.550	V
	NCP1117-3.3	$T_J = 25^\circ C$ $4.8 V \leq V_{in} \leq 12 V, I_o = 10 mA$		3.235	3.3	3.365	V
	NCP1117-5.0	$T_J = 25^\circ C$ $6.5 V \leq V_{in} \leq 12 V, I_o = 10 mA$		4.900	5	5.100	V
Line Regulation, Adjustable & Fixed (Note 3)	NCP1117-XXX	$T_J = 25^\circ C$ $V_{out} + 1.5 V < V_{in} < 12 V,$ $I_o = 10 mA$	$Reg_{line}$			0.2	%
Load Regulation (Note 3)	NCP1117-ADJ	$T_J = 25^\circ C$ $10 mA < I_o < 1 A, V_{in} = 3.3 V$	$Reg_{load}$			1	%
	NCP1117-1.5	$T_J = 25^\circ C$ $10 mA < I_o < 1 A, V_{in} = 3 V$			12	15	mV
	NCP1117-1.8	$T_J = 25^\circ C$ $10 mA < I_o < 1 A, V_{in} = 3.3 V$			15	18	mV
	NCP1117-2.5	$T_J = 25^\circ C$ $10 mA < I_o < 1 A, V_{in} = 4 V$			20	25	mV
	NCP1117-3.3	$T_J = 25^\circ C$ $10 mA < I_o < 1 A, V_{in} = 4.7 V$			26	33	mV
	NCP1117-5.0	$T_J = 25^\circ C$ $10 mA < I_o < 1 A, V_{in} = 6.5 V$			40	50	mV
Dropout Voltage ( $V_{in} - V_{out}$ ), Adjustable & Fixed	NCP1117-XXX	$I_{out} = 1 A, T_A = 25^\circ C$ $\Delta V_{out} = V_{out} - 100 mV$			1.3	1.4	V
Current Limit, Adjustable & Fixed	NCP1117-XXX	$V_{in} = 7 V, T_A = 25^\circ C$	$I_{out}$	1.1			A
Minimum Load Current (Note 4)	NCP1117-XXX	$0^\circ C \leq T_J \leq 125^\circ C$	$I_{Lmin}$		1	5	mA
Quiescent Current	NCP1117-fixed	$V_{in} = 12 V$ $I_o = 10 mA$	$I_{QFIX}$		550	700	$\mu A$
	NCP1117-ADJ		$I_{QADJ}$		30	50	$\mu A$
Thermal Regulation (Note 5)		$T_A = 25^\circ C, T = 30 ms$ pulse			0.008	0.04	%W
Ripple Rejection	NCP1117-XXX	$F = 120 Hz, C_{out} = 25 \mu F$ tantalum, $I_{out} = 1 A, V_{in} = V_{out} + 3 V$	RR		60		dB
Thermal Shutdown	NCP1117-XXX		$T_{shdn}$		165		$^\circ C$
Thermal Hysteresis	NCP1117-XXX		$T_{hyst}$		10		$^\circ C$

Product parametric performance is indicated in the Electrical Characteristics for the listed test conditions, unless otherwise noted. Product performance may not be indicated by the Electrical Characteristics if operated under different conditions.

3. Low duty cycle pulse techniques are used during testing to maintain the junction temperature as close to ambient as possible.
4. Guaranteed by design.
5. Thermal Regulation is defined as the change in output voltage at a time after a change in power dissipation is applied, excluding load or line regulation effects. Specifications are for a current pulse equal to  $I_{o,max}$  at  $V_{IN} = V_{IN} + 1.5 V$  for  $T = 30 msec$ . Guaranteed by characterization.

# NCP1117LP

## TYPICAL CHARACTERISTICS

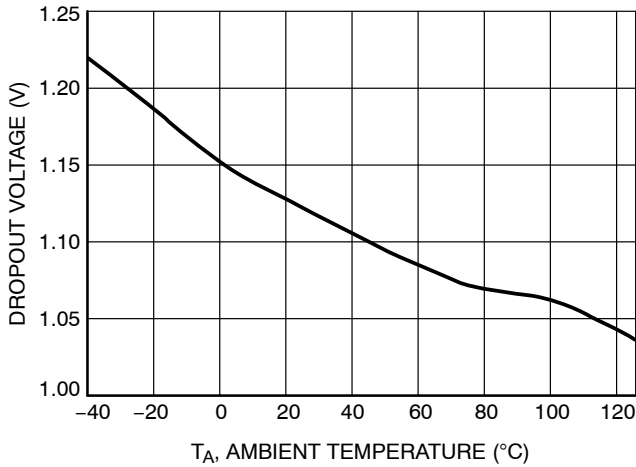

**Figure 4. Dropout Voltage vs. Temperature**  
 $I_{load} = 10\text{ mA}$

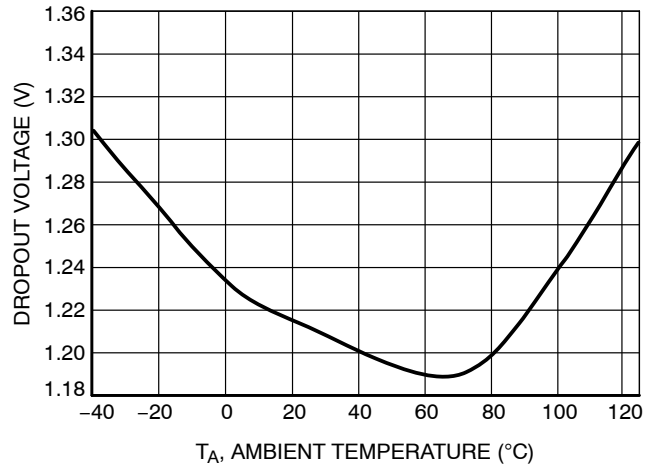

**Figure 5. Dropout Voltage vs. Temperature**  
 $I_{load} = 1\text{ A}$

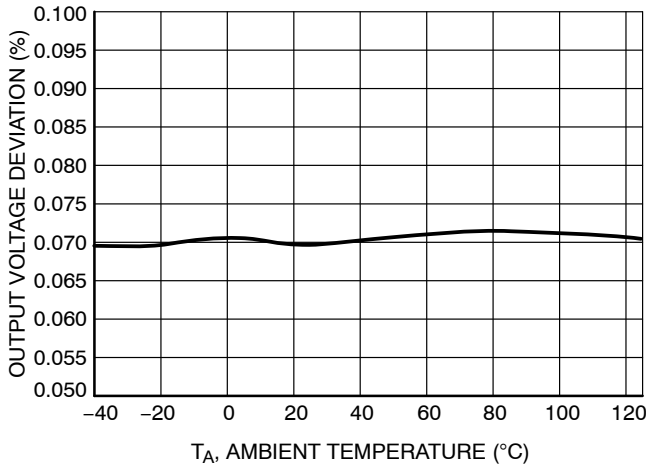

**Figure 6. Line Regulation vs. Temperature**  
 $I_{load} = 10\text{ mA}$

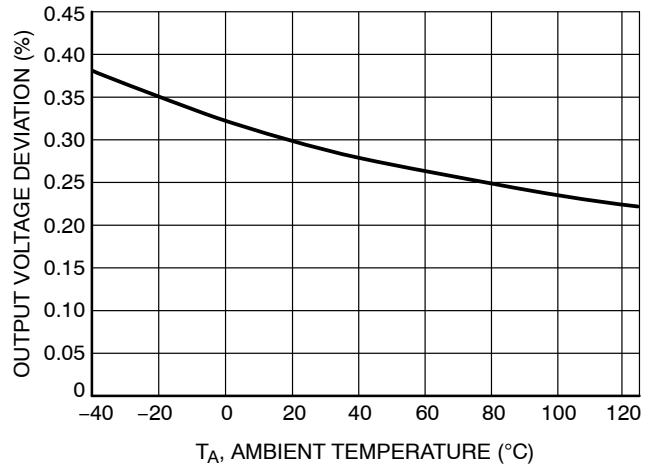

**Figure 7. Load Regulation vs. Temperature**  
 $I_{load} = 1\text{ A}$

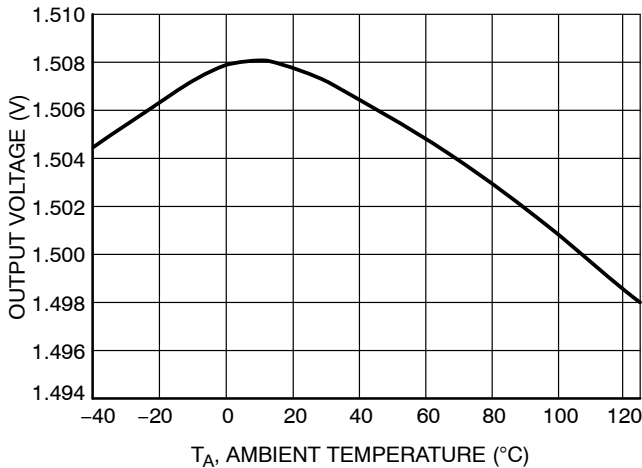

**Figure 8. Output Voltage vs. Temperature**  
 $I_{load} = 10\text{ mA}$

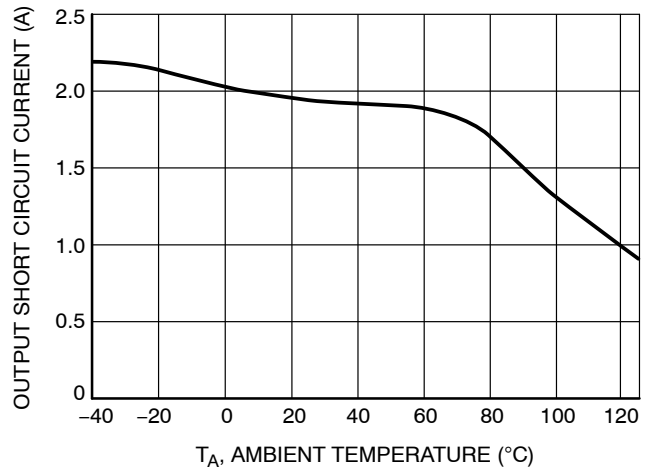

**Figure 9. Output Short Circuit Current vs. Temperature**

# NCP1117LP

## TYPICAL CHARACTERISTICS

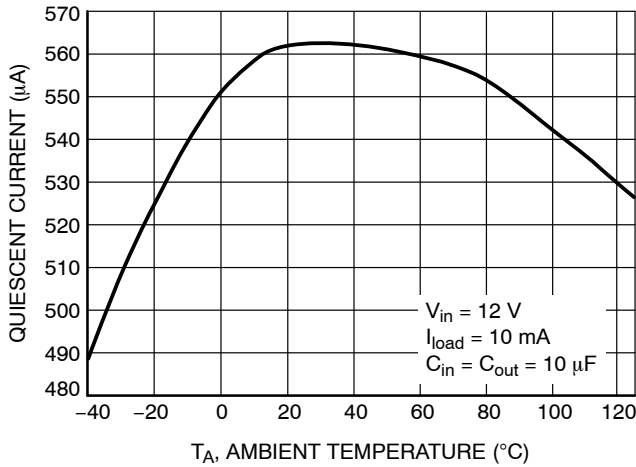

**Figure 10. Quiescent Current vs. Temperature**  
 $I_{load} = 10 \text{ mA}$

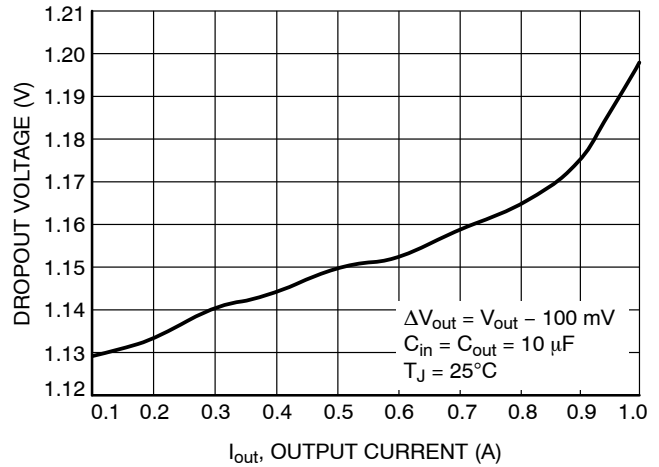

**Figure 11. Dropout Voltage vs. Output Current**

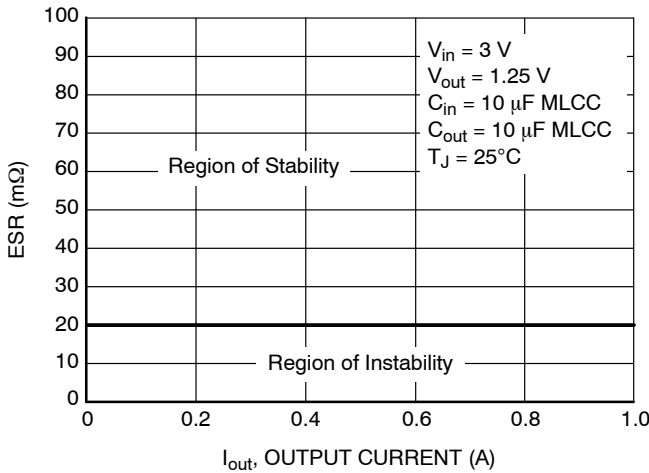

**Figure 12. Equivalent Series Resistance vs. Output Current - MLCC Capacitor**

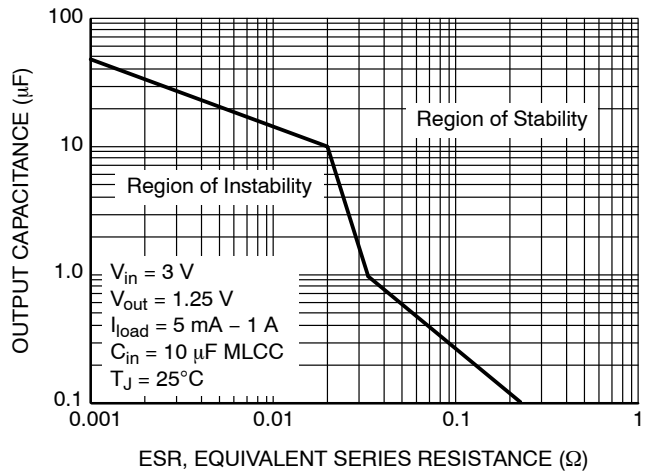

**Figure 13. Output Capacitance vs. ESR MLCC Capacitor**

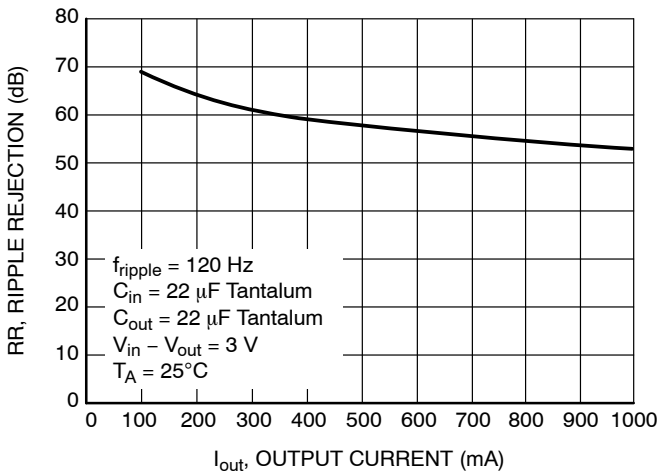

**Figure 14. Ripple Rejection vs. Output Current**  
 - 1.5 V

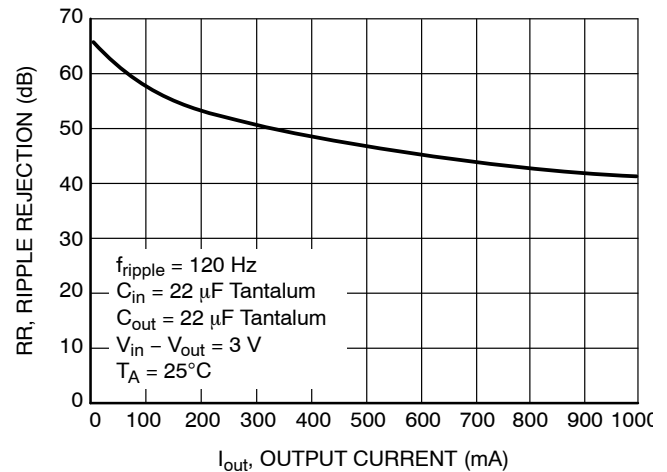

**Figure 15. Ripple Rejection vs. Output Current**  
 - 5 V

TYPICAL CHARACTERISTICS

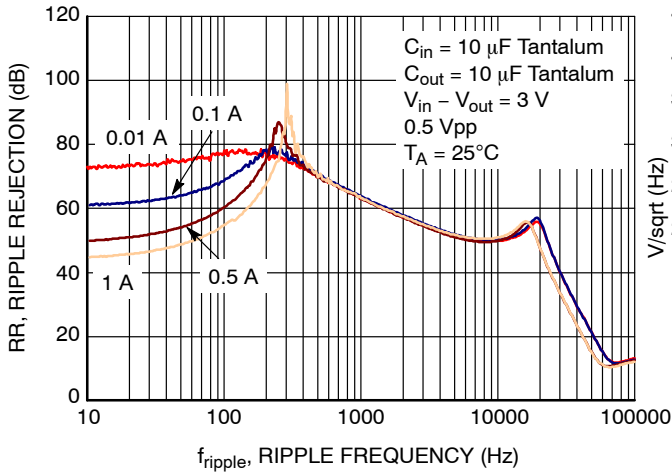

Figure 16. Ripple Rejection vs. Frequency –  $V_{out} = 1.5 V$

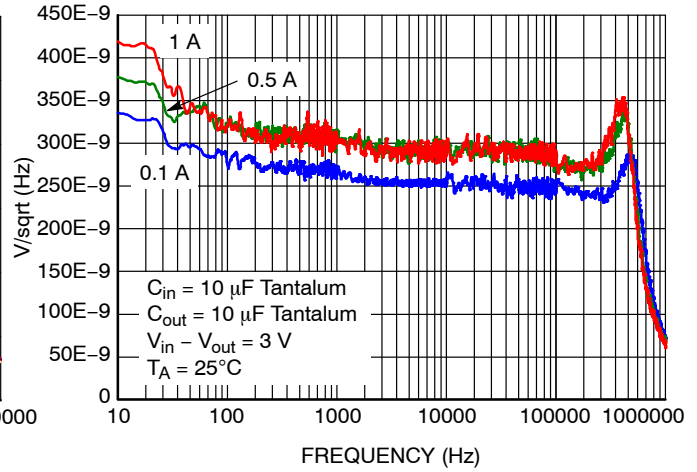

Figure 17. Output Spectral Noise Density vs. Frequency –  $V_{out} = 1V5$

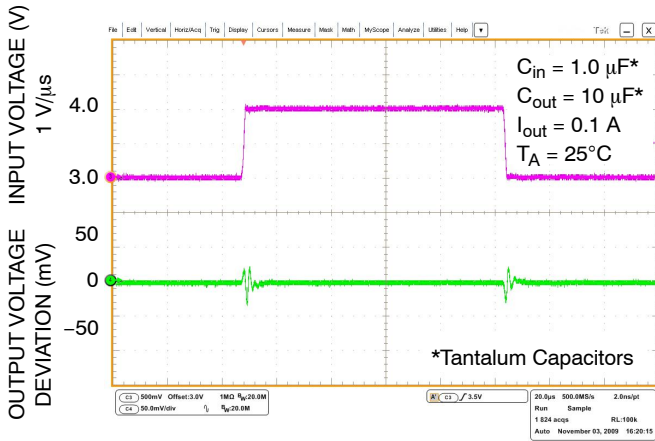

Figure 18. Line Transient Response –  $V_{out} = 1.5 V$

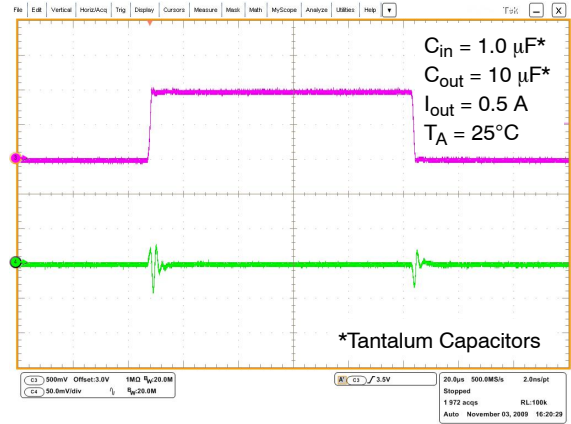

Figure 19. Line Transient Response –  $V_{out} = 1.5 V$

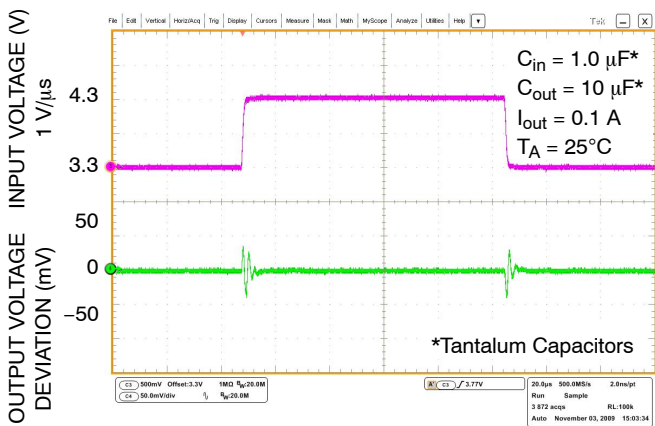

Figure 20. Line Transient Response –  $V_{out} = 1.8 V$

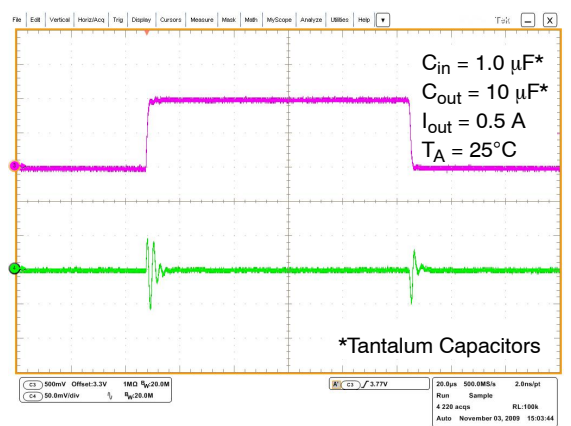

Figure 21. Line Transient Response –  $V_{out} = 1.8 V$

# NCP1117LP

## TYPICAL CHARACTERISTICS

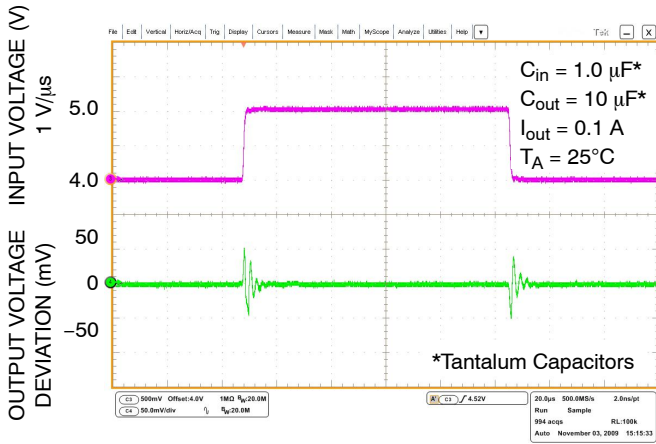

Figure 22. Line Transient Response –  $V_{out} = 2.5\text{ V}$

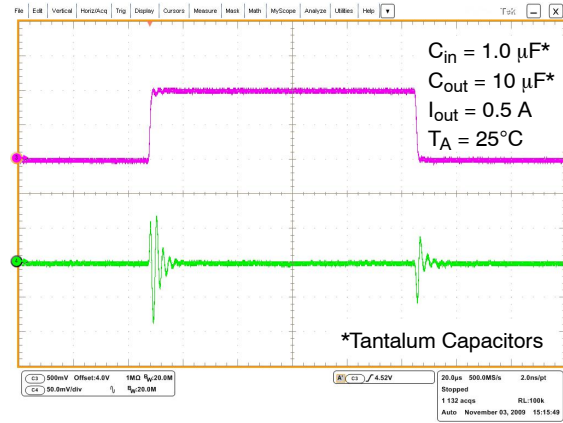

Figure 23. Line Transient Response –  $V_{out} = 2.5\text{ V}$

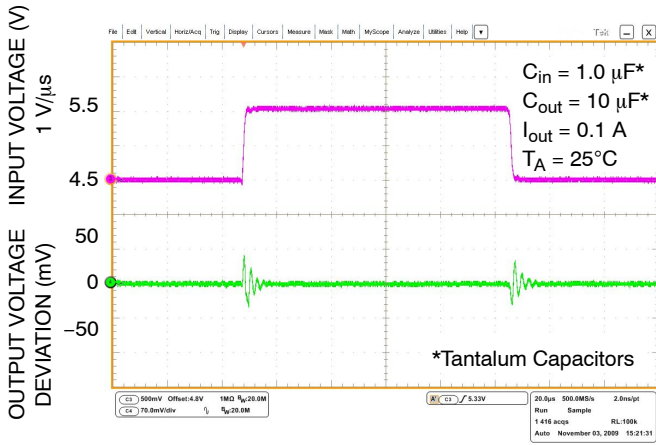

Figure 24. Line Transient Response –  $V_{out} = 3.3\text{ V}$

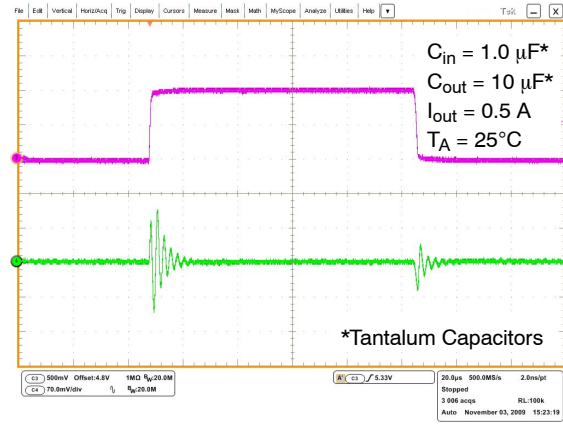

Figure 25. Line Transient Response –  $V_{out} = 3.3\text{ V}$

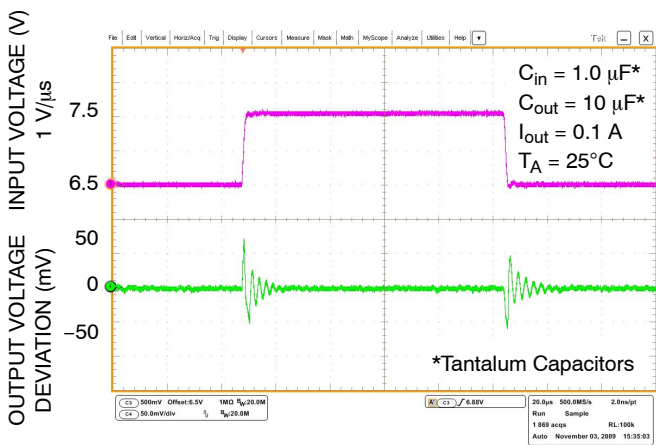

Figure 26. Line Transient Response –  $V_{out} = 5.0\text{ V}$

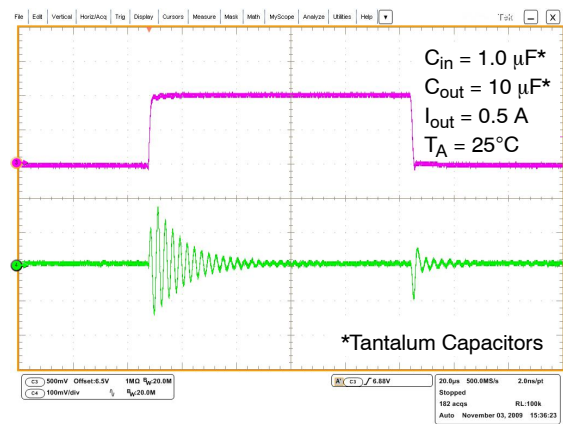

Figure 27. Line Transient Response –  $V_{out} = 5.0\text{ V}$

# NCP1117LP

## TYPICAL CHARACTERISTICS

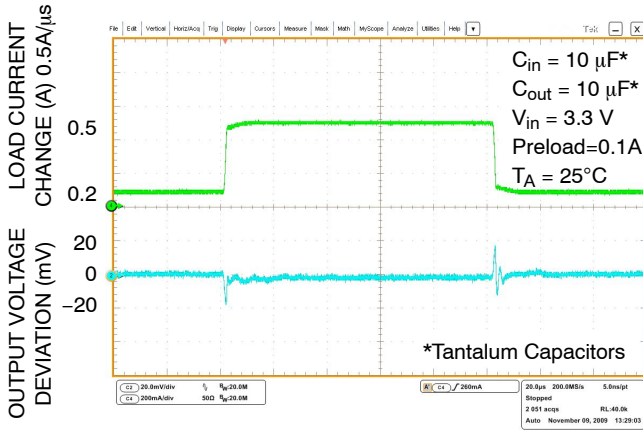

Figure 28. Load Transient Response –  $V_{out} = 1.8V$

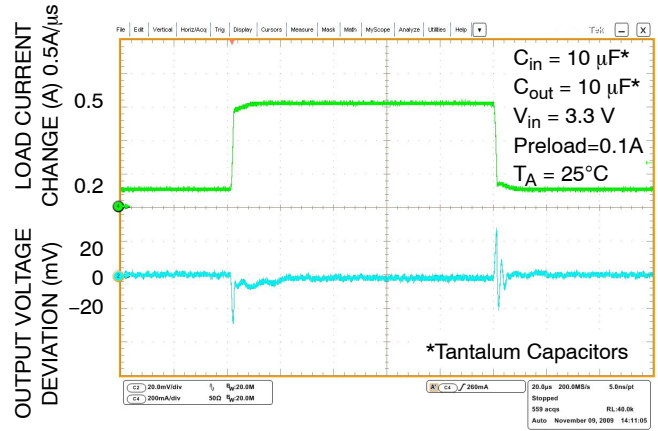

Figure 29. Load Transient Response –  $V_{out} = 2.5V$

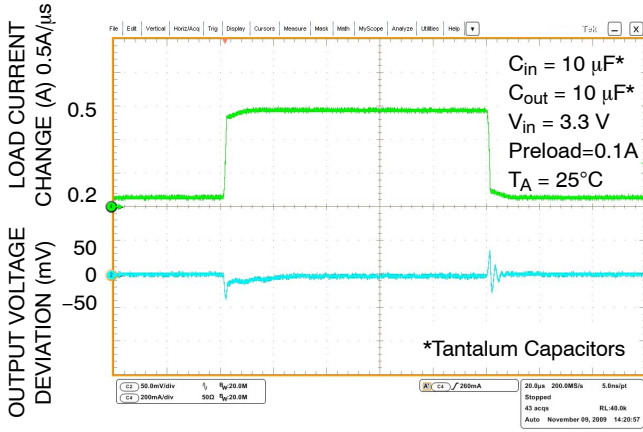

Figure 30. Load Transient Response –  $V_{out} = 3.3V$

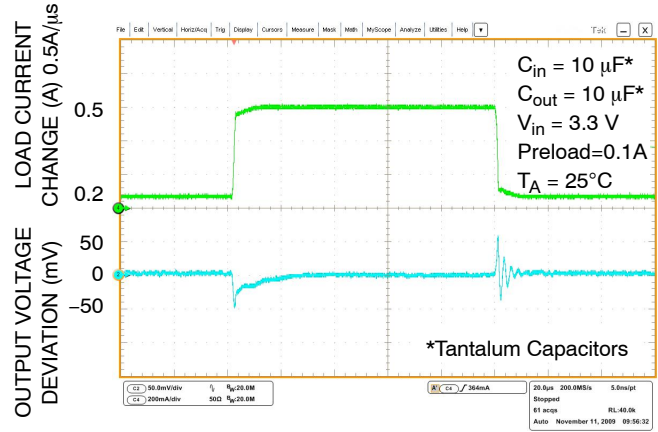

Figure 31. Load Transient Response –  $V_{out} = 5.0V$



# NCP1117LP

## TYPICAL CHARACTERISTICS

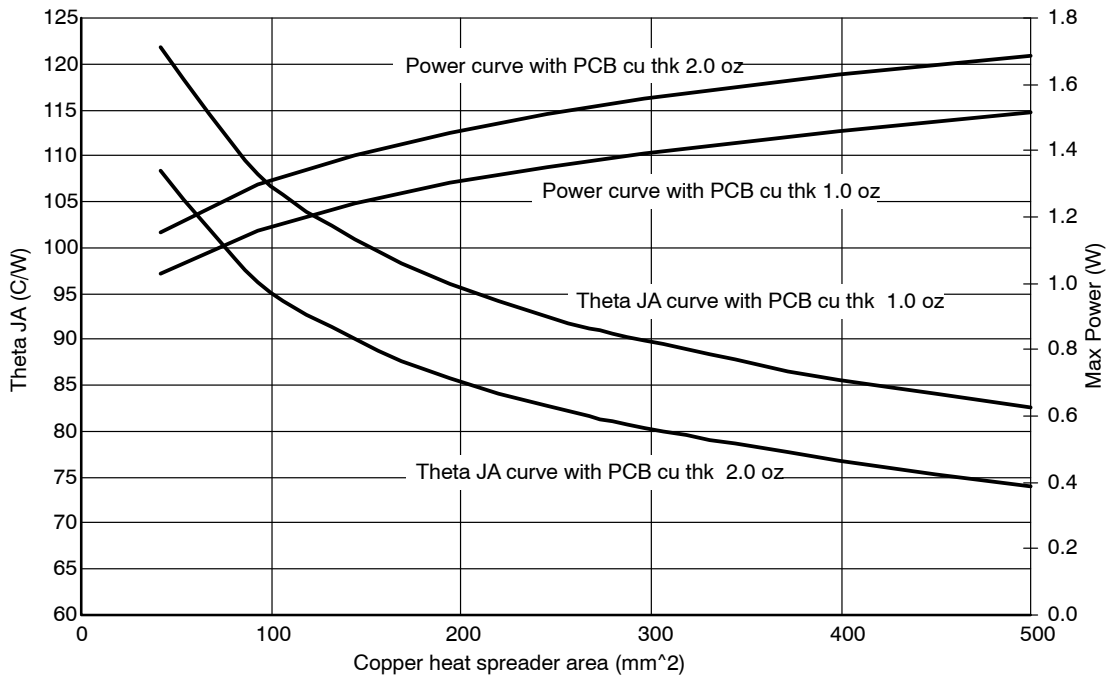

Figure 32. SOT-223 Thermal Resistance and Maximum Power Dissipation vs. P.C.B. Copper Length

APPLICATIONS INFORMATION

Introduction

The NCP1117LP is a low dropout positive fixed or adjustable mode regulator with 1 A output capability. This LDO is guaranteed to have a significant reduction in dropout voltage along with enhanced output voltage accuracy and temperature stability when compared to older industry standard three-terminal adjustable regulators.

These devices contain output current limiting, safe operating area compensation and thermal shutdown protection making them designer friendly for powering numerous consumer and industrial products. The NCP1117LP series is pin compatible with the older NCP1117.

Output Voltage

The typical application circuits for the fixed and adjustable output regulators are shown in Figures 33 and 34. The adjustable devices are floating voltage regulators. They develop and maintain the nominal 1.25 V reference voltage between the output and adjust pins. The reference voltage is programmed to a constant current source by resistor R1, and this current flows through R2 to ground to set the output voltage. The programmed current level is usually selected to be greater than the specified 5.0 mA minimum that is required for regulation. Since the adjust pin current,  $I_{adj}$ , is significantly lower and constant with respect to the programmed load current, it generates a small output voltage error that can usually be ignored. For the fixed output devices R1 and R2 are included within the device and the ground current  $I_{gnd}$  is 550  $\mu$ A (typ).

External Capacitors

Input bypass capacitor  $C_{in}$  may be required for regulator stability if the device is located more than a few inches from the power source. This capacitor will reduce the circuit's sensitivity when powered from a complex source impedance and significantly enhance the output transient response. The input bypass capacitor should be mounted with the shortest possible track length directly across the regulator's input and ground terminals. A 10  $\mu$ F ceramic or tantalum capacitor should be adequate for most applications.

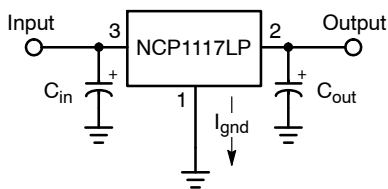
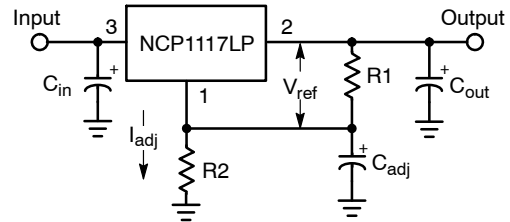

Figure 33. Fixed Output Regulator

Frequency compensation for the regulator is provided by capacitor  $C_{out}$  and its use is mandatory to ensure output stability. A minimum capacitance value of 4.7  $\mu$ F with an equivalent series resistance (ESR) that is within the limits of 20 m $\Omega$  to 20  $\Omega$  is required. The capacitor type can be ceramic, tantalum, or aluminum electrolytic as long as it meets the minimum capacitance value and ESR limits over the circuit's entire operating temperature range. Higher values of output capacitance can be used to enhance loop stability and transient response with the additional benefit of reducing output noise.



$$V_{out} = V_{ref} \left( 1 + \frac{R2}{R1} \right) + R2 \cdot I_{adj}$$

Figure 34. Adjustable Output Regulator

The output ripple will increase linearly for fixed and adjustable devices as the ratio of output voltage to the reference voltage increases. For example, with a 5 V regulator, the output ripple will increase by 5 V/1.25 V or 4 and the ripple rejection will decrease by 20 log of this ratio or 12 dB. The loss of ripple rejection can be restored to the values shown with the addition of bypass capacitor  $C_{adj}$ , shown in Figure 34. The reactance of  $C_{adj}$  at the ripple frequency must be less than the resistance of R1. The value of R1 can be selected to provide the minimum required load current to maintain regulation and is usually in the range of 100  $\Omega$  to 200  $\Omega$ .

$$C_{adj} > \frac{1}{2\pi \cdot f_{ripple} \cdot R1}$$

The minimum required capacitance can be calculated from the above formula. When using the device in an application that is powered from the AC line via a transformer and a full wave bridge, the value for  $C_{adj}$  is:

$$f_{ripple} = 120 \text{ Hz}, R1 = 120 \Omega, \text{ then } C_{adj} > 11.1 \mu\text{F}$$

The value for  $C_{adj}$  is significantly reduced in applications where the input ripple frequency is high. If used as a post regulator in a switching converter under the following conditions:

$$f_{ripple} = 50 \text{ kHz}, R1 = 120 \Omega, \text{ then } C_{adj} > 0.027 \mu\text{F}$$

# NCP1117LP

## Protection Diodes

The NCP1117LP family has two internal low impedance diode paths that normally do not require protection when used in the typical regulator applications. The first path connects between  $V_{out}$  and  $V_{in}$ , and it can withstand a peak surge current of about 15 A. Normal cycling of  $V_{in}$  cannot generate a current surge of this magnitude. Only when  $V_{in}$  is shorted or crowbarred to ground and  $C_{out}$  is greater than 50  $\mu\text{F}$ , it becomes possible for device damage to occur. Under these conditions, diode D1 is required to protect the device. The second path connects between  $C_{adj}$  and  $V_{out}$ , and it can withstand a peak surge current of about 150 mA. Protection diode D2 is required if the output is shorted or crowbarred to ground and  $C_{adj}$  is greater than 1.0  $\mu\text{F}$ .

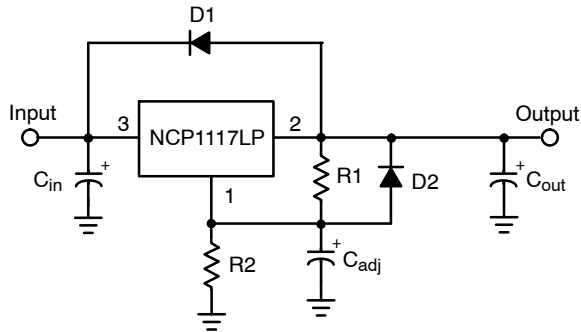

Figure 35. Protection Diode Placement

A combination of protection diodes D1 and D2 may be required in the event that  $V_{in}$  is shorted to ground and  $C_{adj}$  is greater than 50  $\mu\text{F}$ . The peak current capability stated for the internal diodes are for a time of 100  $\mu\text{s}$  with a junction temperature of 25°C. These values may vary and are to be used as a general guide.

## Load Regulation

The NCP1117LP series is capable of providing excellent load regulation; but since these are three terminal devices, only partial remote load sensing is possible. There are two conditions that must be met to achieve the maximum available load regulation performance. The first is that the top side of programming resistor R1 should be connected as close to the regulator case as practicable. This will minimize the voltage drop caused by wiring resistance  $RW+$  from appearing in series with reference voltage that is across R1. The second condition is that the ground end of R2 should be connected directly to the load. This allows true Kelvin sensing where the regulator compensates for the voltage drop caused by wiring resistance  $RW-$ .

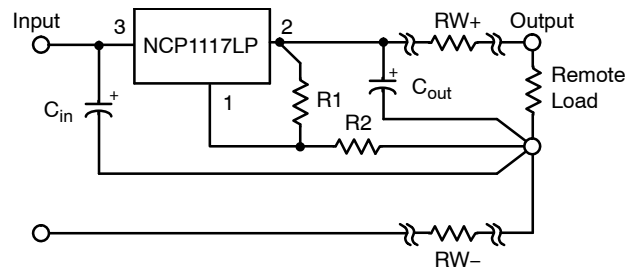

Figure 36. Load Sensing

## Thermal Considerations

This series contains an internal thermal limiting circuit that is designed to protect the regulator in the event that the maximum junction temperature is exceeded. When activated, typically at 165°C, the regulator output switches off and then back on as the die cools. As a result, if the device is continuously operated in an overheated condition, the output will appear to be oscillating. This feature provides protection from a catastrophic device failure due to accidental overheating. It is not intended to be used as a substitute for proper heatsinking. The maximum device power dissipation can be calculated by:

$$P_D = \frac{T_{J(max)} - T_A}{R_{\theta JA}}$$

The devices are available in surface mount SOT-223 package. This package has an exposed metal tab that is specifically designed to reduce the junction to air thermal resistance,  $R_{\theta JA}$ , by utilizing the printed circuit board copper as a heat dissipater. Figure 32 shows typical  $R_{\theta JA}$  values that can be obtained from a square pattern using economical single sided 1.0 oz and 2.0 oz copper board material. The final product thermal limits should be tested and quantified in order to insure acceptable performance and reliability. The actual  $R_{\theta JA}$  can vary considerably from the graphs shown. This will be due to any changes made in the copper aspect ratio of the final layout, adjacent heat sources, and air flow.

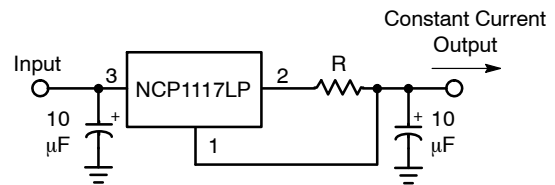

$$I_{out} = \frac{V_{ref}}{R} + I_{adj}$$

Figure 37. Constant Current Regulator

## NCP1117LP

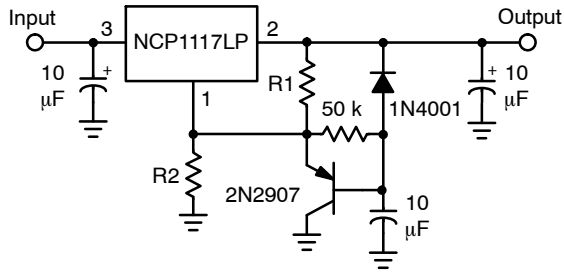

**Figure 38. Slow Turn-On Regulator**

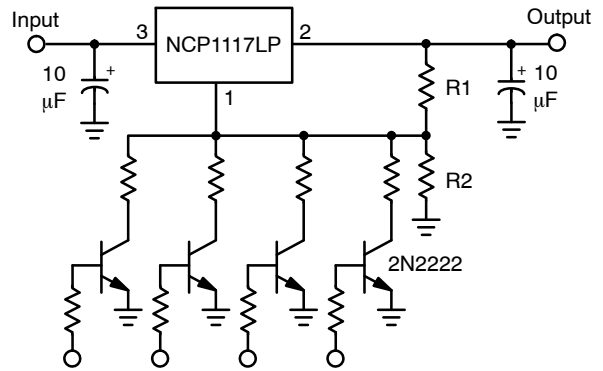

Output Voltage Control

Resistor R2 sets the maximum output voltage. Each transistor reduces the output voltage when turned on.

**Figure 39. Digitally Controlled Regulator**

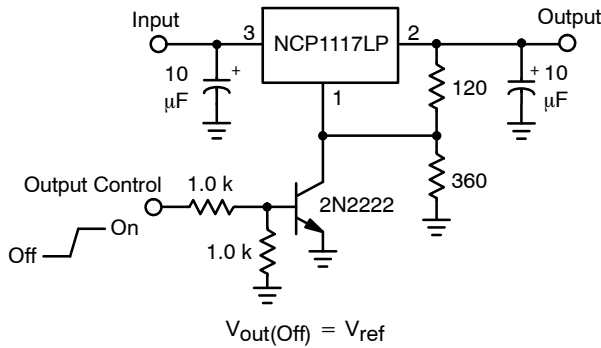

**Figure 40. Regulator with Shutdown**

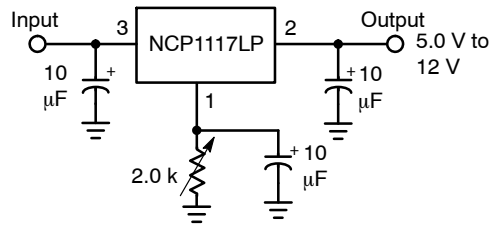

**Figure 41. Adjusting Output of Fixed Voltage Regulators**

### DEVICE ORDERING INFORMATION

Device	Package	Shipping <sup>†</sup>
NCP1117LPST15T3G	SOT-223 (Pb-Free)	4000 / Tape & Reel
NCP1117LPST18T3G		
NCP1117LPST25T3G		
NCP1117LPST33T3G		
NCP1117LPST50T3G		
NCP1117LPSTADT3G		
NCP1117LPDT18RKG	DPAK (Pb-Free)	2500 / Tape & Reel
NCP1117LPDT33RKG		
NCP1117LPDTADJRKG		

<sup>†</sup>For information on tape and reel specifications, including part orientation and tape sizes, please refer to our Tape and Reel Packaging Specifications Brochure, BRD8011/D.

# NCP1117LP

## PACKAGE DIMENSIONS

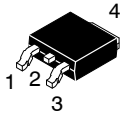

### DPAK (SINGLE GAUGE) CASE 369C ISSUE G

DATE 31 MAY 2023

SCALE 1:1

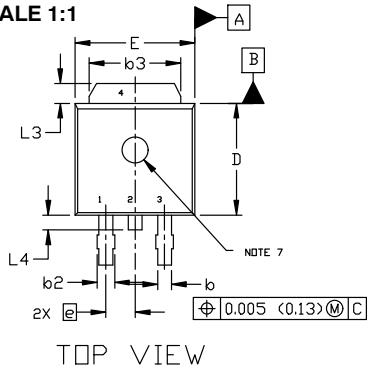

TOP VIEW

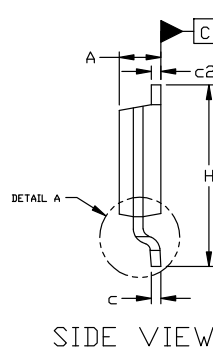

SIDE VIEW

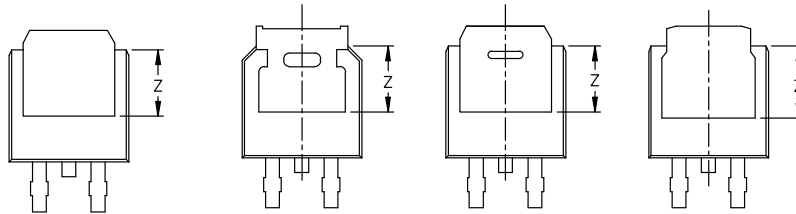

BOTTOM VIEW

BOTTOM VIEW

ALTERNATE CONSTRUCTIONS

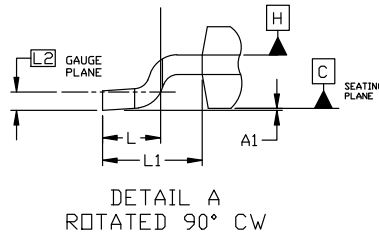
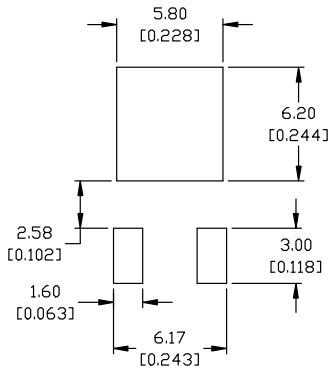

DETAIL A  
ROTATED 90° CW

NOTES:

1. DIMENSIONING AND TOLERANCING ASME Y14.5M, 1994.
2. CONTROLLING DIMENSION: INCHES
3. THERMAL PAD CONTOUR OPTIONAL WITHIN DIMENSIONS b3, L3, AND Z.
4. DIMENSIONS D AND E DO NOT INCLUDE MOLD FLASH, PROTRUSIONS, OR BURRS. MOLD FLASH, PROTRUSIONS, OR GATE BURRS SHALL NOT EXCEED 0.006 INCHES PER SIDE.
5. DIMENSIONS D AND E ARE DETERMINED AT THE OUTERMOST EXTREMES OF THE PLASTIC BODY.
6. DATUMS A AND B ARE DETERMINED AT DATUM PLANE H.
7. OPTIONAL MOLD FEATURE.

DIM	INCHES		MILLIMETERS	
	MIN.	MAX.	MIN.	MAX.
A	0.086	0.094	2.18	2.38
A1	0.000	0.005	0.00	0.13
b	0.025	0.035	0.63	0.89
b2	0.028	0.045	0.72	1.14
b3	0.180	0.215	4.57	5.46
c	0.018	0.024	0.46	0.61
c2	0.018	0.024	0.46	0.61
D	0.235	0.245	5.97	6.22
E	0.250	0.265	6.35	6.73
e	0.090 BSC		2.29 BSC	
H	0.370	0.410	9.40	10.41
L	0.055	0.070	1.40	1.78
L1	0.114 REF		2.90 REF	
L2	0.020 BSC		0.51 BSC	
L3	0.035	0.050	0.89	1.27
L4	----	0.040	---	1.01
Z	0.155	----	3.93	---

### GENERIC MARKING DIAGRAM\*

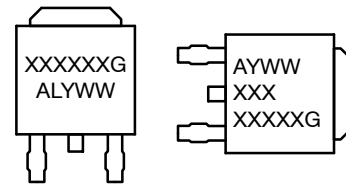

IC

Discrete

- XXXXXX = Device Code
- A = Assembly Location
- L = Wafer Lot
- Y = Year
- WW = Work Week
- G = Pb-Free Package

### RECOMMENDED MOUNTING FOOTPRINT\*

\*FOR ADDITIONAL INFORMATION ON OUR Pb-FREE STRATEGY AND SOLDERING DETAILS, PLEASE DOWNLOAD THE ON SEMICONDUCTOR SOLDERING AND MOUNTING TECHNIQUES REFERENCE MANUAL, SOLDERM/D.

- |  |  |   |   |  |
|--|--|---|---|--|
| <p>STYLE 1:<br/>PIN 1. BASE<br/>2. COLLECTOR<br/>3. EMITTER<br/>4. COLLECTOR</p> | <p>STYLE 2:<br/>PIN 1. GATE<br/>2. DRAIN<br/>3. SOURCE<br/>4. DRAIN</p>          | <p>STYLE 3:<br/>PIN 1. ANODE<br/>2. CATHODE<br/>3. ANODE<br/>4. CATHODE</p> | <p>STYLE 4:<br/>PIN 1. CATHODE<br/>2. ANODE<br/>3. GATE<br/>4. ANODE</p>              | <p>STYLE 5:<br/>PIN 1. GATE<br/>2. ANODE<br/>3. CATHODE<br/>4. ANODE</p>     |
| <p>STYLE 6:<br/>PIN 1. MT1<br/>2. MT2<br/>3. GATE<br/>4. MT2</p>                 | <p>STYLE 7:<br/>PIN 1. GATE<br/>2. COLLECTOR<br/>3. EMITTER<br/>4. COLLECTOR</p> | <p>STYLE 8:<br/>PIN 1. N/C<br/>2. CATHODE<br/>3. ANODE<br/>4. CATHODE</p>   | <p>STYLE 9:<br/>PIN 1. ANODE<br/>2. CATHODE<br/>3. RESISTOR ADJUST<br/>4. CATHODE</p> | <p>STYLE 10:<br/>PIN 1. CATHODE<br/>2. ANODE<br/>3. CATHODE<br/>4. ANODE</p> |

\*This information is generic. Please refer to device data sheet for actual part marking. Pb-Free indicator, "G" or microdot "•", may or may not be present. Some products may not follow the Generic Marking.

# MECHANICAL CASE OUTLINE PACKAGE DIMENSIONS

ON Semiconductor®



**SOT-223**  
**CASE 318H**  
**ISSUE B**

DATE 13 MAY 2020

SCALE 2:1



TOP VIEW

$\Phi 0.10 \text{ (M)}$  C A B

NOTE 7

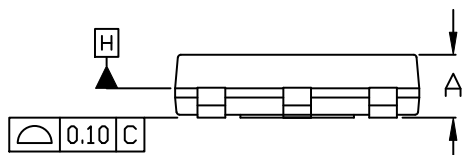

SIDE VIEW

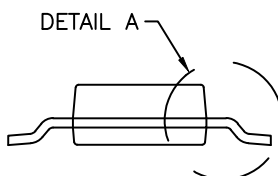

END VIEW

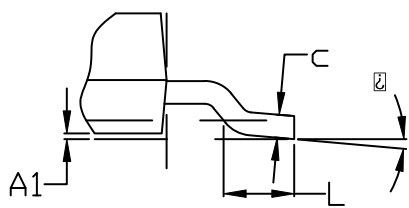

DETAIL A

**NOTES:**

1. DIMENSIONING AND TOLERANCING PER ASME Y14.5M, 2009.
2. CONTROLLING DIMENSION: MILLIMETERS
3. DIMENSIONS D & E1 ARE DETERMINED AT DATUM H. DIMENSIONS DO NOT INCLUDE MOLD FLASH, PROTRUSIONS OR GATE BURRS. SHALL NOT EXCEED 0.23mm PER SIDE.
4. LEAD DIMENSIONS b AND b1 DO NOT INCLUDE DAMBAR PROTRUSION. ALLOWABLE DAMBAR PROTRUSION IS 0.08mm PER SIDE.
5. DATUMS A AND B ARE DETERMINED AT DATUM H.
6. A1 IS DEFINED AS THE VERTICAL DISTANCE FROM THE SEATING PLANE TO THE LOWEST POINT OF THE PACKAGE BODY.
7. POSITIONAL TOLERANCE APPLIES TO DIMENSIONS b AND b1.

DIM	MILLIMETERS		
	MIN.	NDM.	MAX.
A	---	---	1.80
A1	0.02	0.06	0.11
b	0.60	0.74	0.88
b1	2.90	3.00	3.10
c	0.24	---	0.35
D	6.30	6.50	6.70
E	6.70	7.00	7.30
E1	3.30	3.50	3.70
e	2.30 BSC		
L	0.25	---	---
$\square$	0°	---	10°

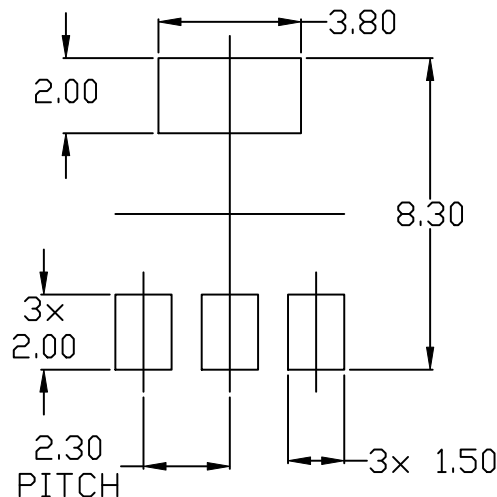

RECOMMENDED MOUNTING FOOTPRINT

\* For additional information on our Pb-Free strategy and soldering details, please download the ON Semiconductor Soldering and Mounting Techniques Reference Manual, SOLDERM/D.

**GENERIC MARKING DIAGRAM\***

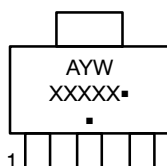

- A = Assembly Location
- Y = Year
- W = Work Week
- XXXXX = Specific Device Code
- = Pb-Free Package

(Note: Microdot may be in either location)

\*This information is generic. Please refer to device data sheet for actual part marking. Pb-Free indicator, "G" or microdot "▪", may or may not be present. Some products may not follow the Generic Marking.

<b>DOCUMENT NUMBER:</b>	<b>98ASH70634A</b>	Electronic versions are uncontrolled except when accessed directly from the Document Repository. Printed versions are uncontrolled except when stamped "CONTROLLED COPY" in red.
<b>DESCRIPTION:</b>	<b>SOT-223</b>	<b>PAGE 1 OF 1</b>

ON Semiconductor and are trademarks of Semiconductor Components Industries, LLC dba ON Semiconductor or its subsidiaries in the United States and/or other countries. ON Semiconductor reserves the right to make changes without further notice to any products herein. ON Semiconductor makes no warranty, representation or guarantee regarding the suitability of its products for any particular purpose, nor does ON Semiconductor assume any liability arising out of the application or use of any product or circuit, and specifically disclaims any and all liability, including without limitation special, consequential or incidental damages. ON Semiconductor does not convey any license under its patent rights nor the rights of others.

**onsemi**, **Onsemi**, and other names, marks, and brands are registered and/or common law trademarks of Semiconductor Components Industries, LLC dba "**onsemi**" or its affiliates and/or subsidiaries in the United States and/or other countries. **onsemi** owns the rights to a number of patents, trademarks, copyrights, trade secrets, and other intellectual property. A listing of **onsemi**'s product/patent coverage may be accessed at [www.onsemi.com/site/pdf/Patent-Marking.pdf](http://www.onsemi.com/site/pdf/Patent-Marking.pdf). **onsemi** reserves the right to make changes at any time to any products or information herein, without notice. The information herein is provided "as-is" and **onsemi** makes no warranty, representation or guarantee regarding the accuracy of the information, product features, availability, functionality, or suitability of its products for any particular purpose, nor does **onsemi** assume any liability arising out of the application or use of any product or circuit, and specifically disclaims any and all liability, including without limitation special, consequential or incidental damages. Buyer is responsible for its products and applications using **onsemi** products, including compliance with all laws, regulations and safety requirements or standards, regardless of any support or applications information provided by **onsemi**. "Typical" parameters which may be provided in **onsemi** data sheets and/or specifications can and do vary in different applications and actual performance may vary over time. All operating parameters, including "Typicals" must be validated for each customer application by customer's technical experts. **onsemi** does not convey any license under any of its intellectual property rights nor the rights of others. **onsemi** products are not designed, intended, or authorized for use as a critical component in life support systems or any FDA Class 3 medical devices or medical devices with a same or similar classification in a foreign jurisdiction or any devices intended for implantation in the human body. Should Buyer purchase or use **onsemi** products for any such unintended or unauthorized application, Buyer shall indemnify and hold **onsemi** and its officers, employees, subsidiaries, affiliates, and distributors harmless against all claims, costs, damages, and expenses, and reasonable attorney fees arising out of, directly or indirectly, any claim of personal injury or death associated with such unintended or unauthorized use, even if such claim alleges that **onsemi** was negligent regarding the design or manufacture of the part. **onsemi** is an Equal Opportunity/Affirmative Action Employer. This literature is subject to all applicable copyright laws and is not for resale in any manner.

## ADDITIONAL INFORMATION

### TECHNICAL PUBLICATIONS:

Technical Library: [www.onsemi.com/design/resources/technical-documentation](http://www.onsemi.com/design/resources/technical-documentation)  
onsemi Website: [www.onsemi.com](http://www.onsemi.com)

### ONLINE SUPPORT: [www.onsemi.com/support](http://www.onsemi.com/support)

For additional information, please contact your local Sales Representative at [www.onsemi.com/support/sales](http://www.onsemi.com/support/sales)