

3.0 A, Very Low-Dropout (VLDO) Fast Transient Response Regulator series

NCP59302, NCV59302

The NCP59302 is a high precision, very low dropout (VLDO), low ground current positive voltage regulator that is capable of providing an output current in excess of 3.0 A with a typical dropout voltage lower than 300 mV at 3.0 A load current. The device is stable with ceramic output capacitors. The device can withstand up to 18 V max input voltage.

Internal protection features consist of output current limiting, built-in thermal shutdown and reverse output current protection. Logic level enable pin is available. The NCP59302 is an adjustable voltage device and is available in D2PAK-5 package.

Features

- Output Current in Excess of 3.0 A
- 300 mV Typical Dropout Voltage at 3.0 A
- Adjustable Output Voltage Range from 1.24 V to 13 V
- Low Ground Current
- Fast Transient Response
- Stable with Ceramic Output Capacitor
- Logic Compatible Enable Pin
- Current Limit, Reverse Current and Thermal Shutdown Protection
- Operation up to 13.5 V Input Voltage
- NCV Prefix for Automotive and Other Applications Requiring Unique Site and Control Change Requirements; AEC-Q100 Qualified and PPAP Capable
- These are Pb-Free Devices

Applications

- Consumer and Industrial Equipment Point of Regulation
- Servers and Networking Equipment
- FPGA, DSP and Logic Power supplies
- Switching Power Supply Post Regulation
- Battery Chargers
- Functional Replacement for Industry Standard MIC29300, MIC39300, MIC37300

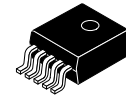

D²PAK
CASE 936A

MARKING DIAGRAM

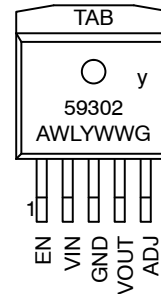

| | |
|----|---------------------|
| y | = P (NCP), V (NCV) |
| A | = Assembly Location |
| WL | = Wafer Lot |
| Y | = Year |
| WW | = Work Week |
| G | = Pb-Free Package |

ORDERING INFORMATION

See detailed ordering and shipping information in the package dimensions section on page 9 of this data sheet.

NCP59302, NCV59302

TYPICAL APPLICATIONS

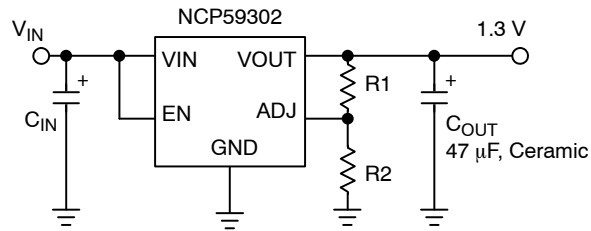

Figure 1. Adjustable Regulator

PIN FUNCTION DESCRIPTION

| Pin Number | Pin Name | Pin Function |
|------------|----------|---|
| 1 | EN | Enable Input: CMOS and TTL logic compatible. Logic high = enable; Logic low = shutdown. |
| 2 | VIN | Input voltage which supplies both the internal circuitry and the current to the output load |
| 3 | GND | Ground |
| TAB | TAB | TAB is connected to ground. |
| 4 | VOOUT | Linear Regulator Output. |
| 5 | ADJ | Adjustable Regulator Feedback Input. Connect to output voltage resistor divider central node. |

ABSOLUTE MAXIMUM RATINGS

| Symbol | Rating | Value | Unit |
|--------------------|---|--|------|
| V_{IN} | Supply Voltage | 0 to 18 | V |
| V_{EN} | Enable Input Voltage | 0 to 18 | V |
| $V_{OUT} - V_{IN}$ | Reverse $V_{OUT} - V_{IN}$ Voltage (EN = Shutdown or $V_{IN} = 0$ V) (Note 1) | 0 to 6.5 | V |
| P_D | Power Dissipation (Notes 2 and 3) | Internally Limited | |
| T_J | Junction Temperature | $-40 \leq T_J \leq +125$ | °C |
| T_S | Storage Temperature | $-65 \leq T_J \leq +150$ | °C |
| | ESD Rating (Notes 4 and 5) | Human Body Model 2000 Machine Model 200 | V |

Stresses exceeding those listed in the Maximum Ratings table may damage the device. If any of these limits are exceeded, device functionality should not be assumed, damage may occur and reliability may be affected.

NOTE: All voltages are referenced to GND pin unless otherwise noted.

- The ENABLE pin input voltage must be ≤ 0.8 V or V_{IN} must be connected to ground potential.
- $P_{D(max)} = (T_{J(max)} - T_A) / R_{\theta JA}$, where $R_{\theta JA}$ depends upon the printed circuit board layout.
- This protection is not guaranteed outside the Recommended Operating Conditions.
- Devices are ESD sensitive. Handling precautions recommended.
- This device series incorporates ESD protection and is tested by the following methods:
ESD Human Body Model (HBM) tested per AEC-Q100-002 (EIA/JESD22-A114C)
ESD Machine Model (MM) tested per AEC-Q100-003 (EIA/JESD22-A115C)
This device contains latch-up protection and exceeds 100 mA per JEDEC Standard JESD78.

RECOMMENDED OPERATING CONDITIONS (Note 6)

| Symbol | Rating | Value | Unit |
|----------|----------------------|--------------------------|------|
| V_{IN} | Supply Voltage | 2.24 to 13.5 | V |
| V_{EN} | Enable Input Voltage | 0 to 13.5 | V |
| T_J | Junction Temperature | $-40 \leq T_J \leq +125$ | °C |

- The device is not guaranteed to function outside its Recommended operating conditions.

NCP59302, NCV59302

ELECTRICAL CHARACTERISTICS

$T_J = 25\text{ }^\circ\text{C}$ with $V_{IN} = V_{OUT\text{ nominal}} + 1\text{ V}$; $V_{EN} = V_{IN}$; $I_L = 10\text{ mA}$; bold values indicate $-40\text{ }^\circ\text{C} < T_J < +125\text{ }^\circ\text{C}$, unless noted.

| Parameter | Conditions | Min | Typ | Max | Unit |
|---|--|-----|------|------------------|---------------|
| Output Voltage Accuracy | $I_L = 10\text{ mA}$ | -1 | - | +1 | % |
| | $10\text{ mA} < I_{OUT} < 3\text{ A}$, $V_{OUT\text{ nominal}} + 1 \leq V_{IN} \leq 13.5\text{ V}$ | -2 | - | +2 | % |
| Output Voltage Line Regulation | $V_{IN} = V_{OUT\text{ nominal}} + 1.0\text{ V to }13.5\text{ V}$; $I_L = 10\text{ mA}$ | - | 0.02 | 0.5 | % |
| Output Voltage Load Regulation | $I_L = 10\text{ mA to }3\text{ A}$ | - | 0.2 | 1 | % |
| $V_{IN} - V_{OUT}$ Dropout Voltage (Note 7) | $I_L = 1.5\text{ A}$ | - | 175 | 350 | mV |
| | $I_L = 3\text{ A}$ | - | 300 | 500 | mV |
| Ground Pin Current (Note 8) | $I_L = 3\text{ A}$ | - | 60 | 90 120 | mA |
| Ground Pin Current in Shutdown | $V_{EN} \leq 0.5\text{ V}$ | - | 1.0 | 5 | μA |
| Overload Protection Current Limit | $V_{OUT} = 0\text{ V}$ (Note 9) | - | 3.5 | 5 | A |
| Start-up Time | $V_{EN} = V_{IN}$, $V_{OUT\text{ nominal}} = 2.5\text{ V}$, $I_{OUT} = 10\text{ mA}$, $C_{OUT} = 47\text{ }\mu\text{F}$ | - | 100 | 500 | μs |

ENABLE INPUT

| | | | | | |
|----------------------------|--|-----------------------|-------|-----------------------|---------------|
| Enable Input Signal Levels | Regulator enable | 1.8 | - | - | V |
| | Regulator shutdown | - | - | 0.8 | V |
| Enable pin Input Current | $V_{EN} \leq 0.8\text{ V}$ (Regulator shutdown) | - | - | 2 4 | μA |
| | $6.5\text{ V} > V_{EN} \geq 1.8\text{ V}$ (Regulator enable) | 1 | 15 | 30 40 | μA |
| Reference Voltage | | 1.228 1.215 | 1.240 | 1.252 1.265 | V |
| Adjust Pin Bias Current | | - | 100 | 200 350 | nA |

Product parametric performance is indicated in the Electrical Characteristics for the listed test conditions, unless otherwise noted. Product performance may not be indicated by the Electrical Characteristics if operated under different conditions.

7. $V_{DO} = V_{IN} - V_{OUT}$ when V_{OUT} decreases to 98% of its nominal output voltage with $V_{IN} = V_{OUT} + 1\text{ V}$. For output voltages below 1.74 V, dropout voltage specification does not apply due to a minimum input operating voltage of 2.24 V.

8. $I_{IN} = I_{GND} + I_{OUT}$.

9. Device Power-on or Enable Start-up with output shorted to GND.

| Package | Conditions / PCB Footprint | Thermal Resistance |
|---------------------------|--|---|
| D2PAK-5, Junction-to-Case | | $R_{\theta JC} = 2.1\text{ }^\circ\text{C/W}$ |
| D2PAK-5, Junction-to-Air | PCB with 100 mm ² 2.0 oz Copper Heat Spreading Area | $R_{\theta JA} = 52\text{ }^\circ\text{C/W}$ |

NCP59302, NCV59302

TYPICAL CHARACTERISTICS

$T_J = 25^\circ\text{C}$ IF NOT OTHERWISE NOTED

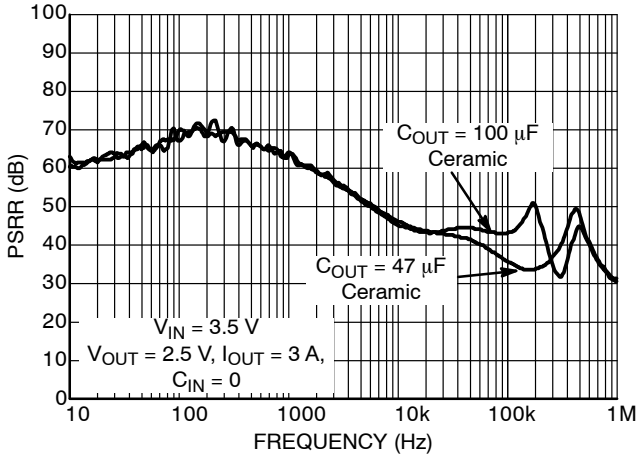

Figure 2. Power Supply Rejection Ratio

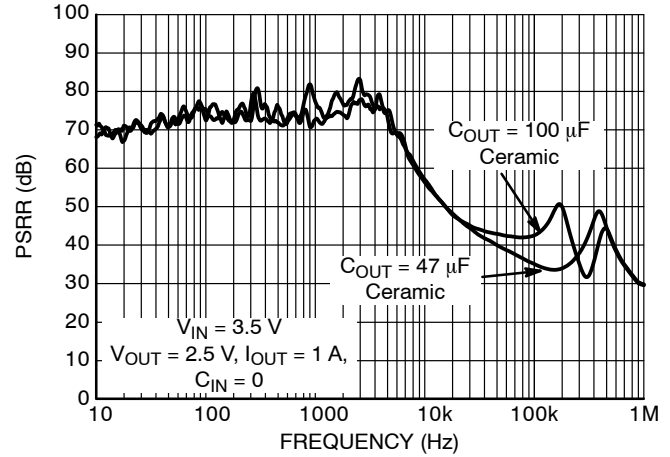

Figure 3. Power Supply Rejection Ratio

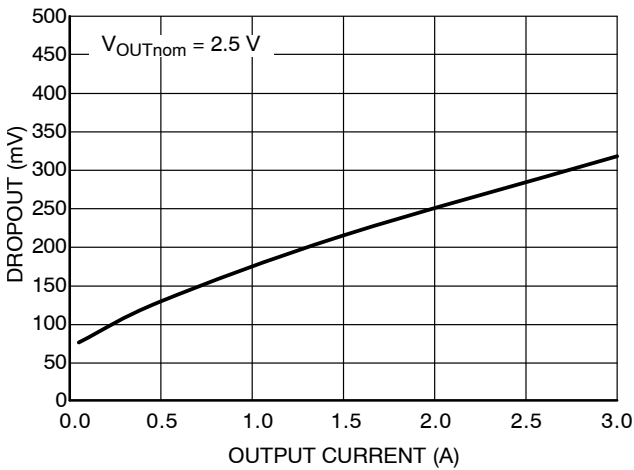

Figure 4. Dropout Voltage vs. Output Current

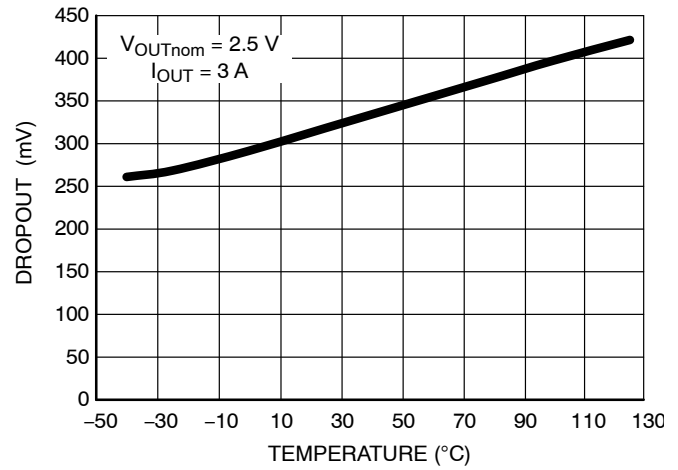

Figure 5. Dropout Voltage vs. Temperature

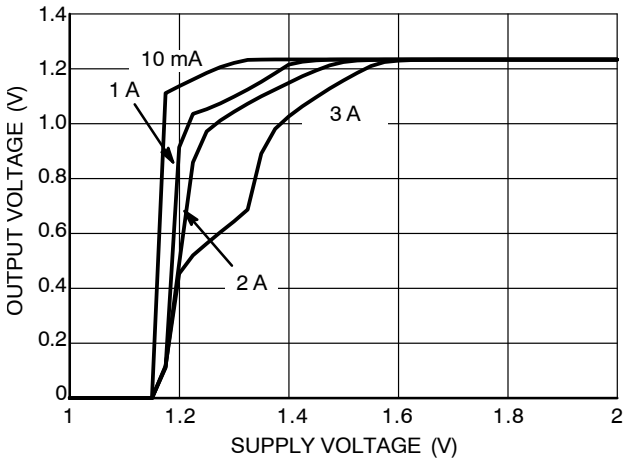

Figure 6. Dropout Characteristics (1.24 V)

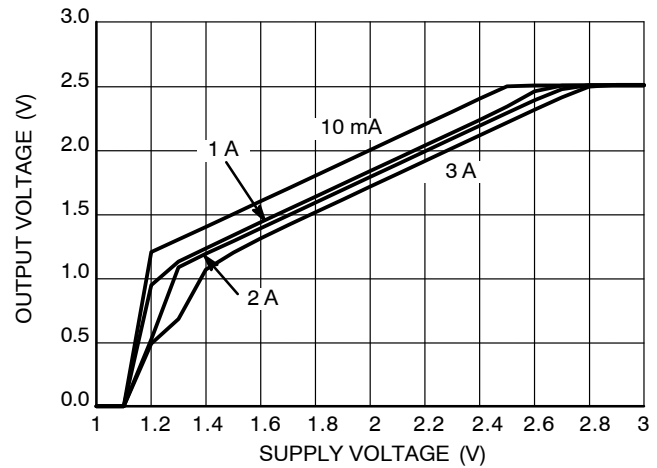

Figure 7. Dropout Characteristics (2.5 V)

NCP59302, NCV59302

TYPICAL CHARACTERISTICS

$T_J = 25\text{ }^\circ\text{C}$ IF NOT OTHERWISE NOTED (continued)

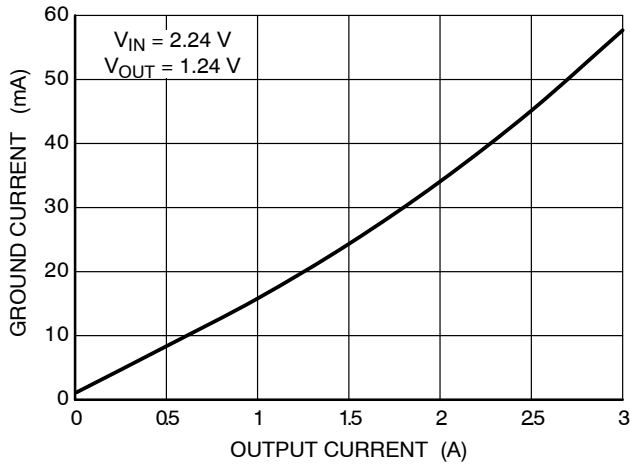

Figure 8. Ground Current vs. Output Current

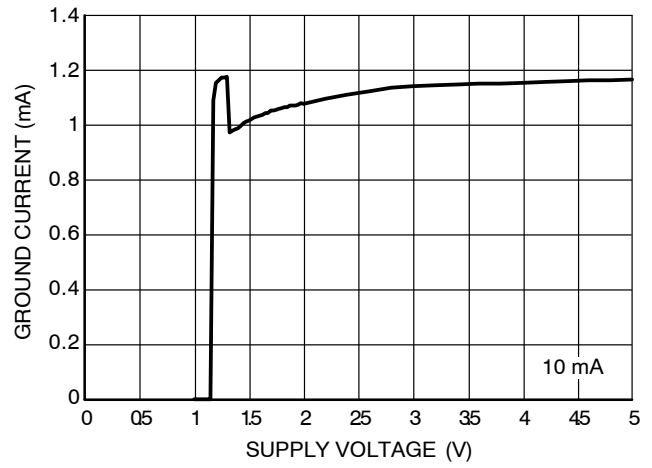

Figure 9. Ground Current vs. Supply Voltage (1.24 V)

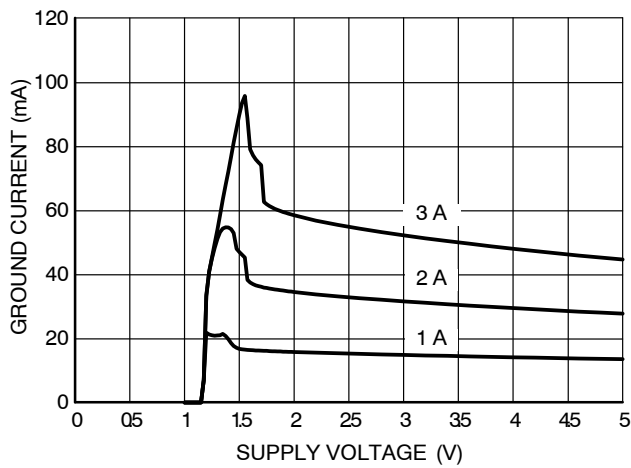

Figure 10. Ground Current vs. Supply Voltage (1.24 V)

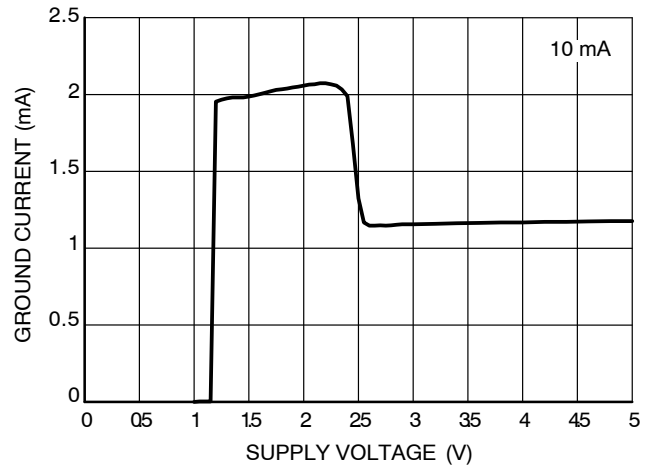

Figure 11. Ground Current vs. Supply Voltage (2.5 V)

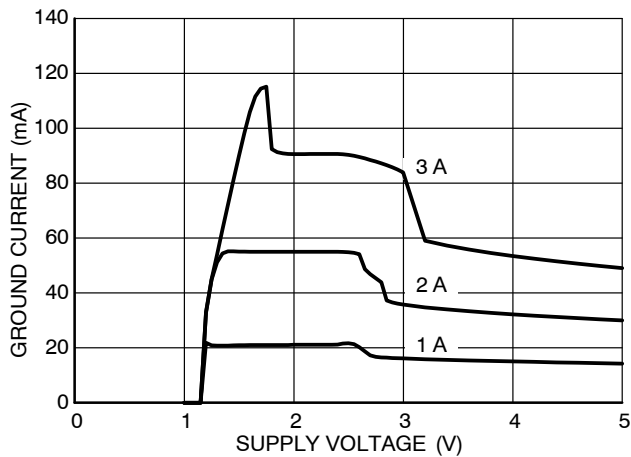

Figure 12. Ground Current vs. Supply Voltage (2.5 V)

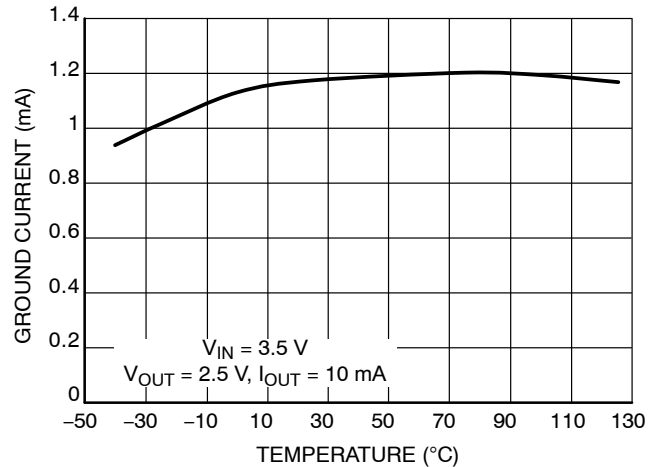

Figure 13. Ground Current vs. Temperature

NCP59302, NCV59302

TYPICAL CHARACTERISTICS

T_J = 25 °C IF NOT OTHERWISE NOTED (continued)

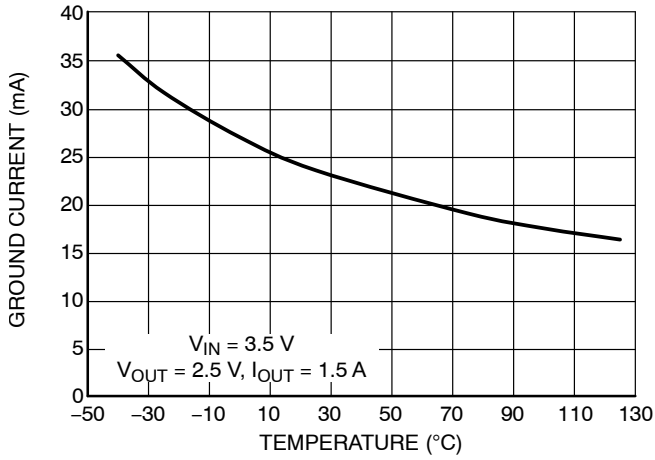

Figure 14. Ground Current vs. Temperature

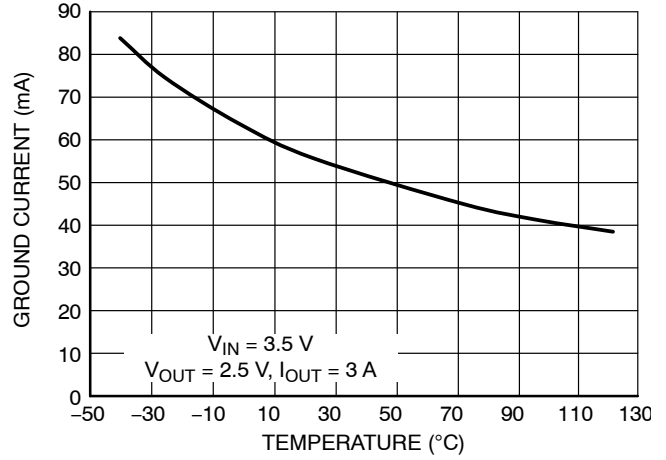

Figure 15. Ground Current vs. Temperature

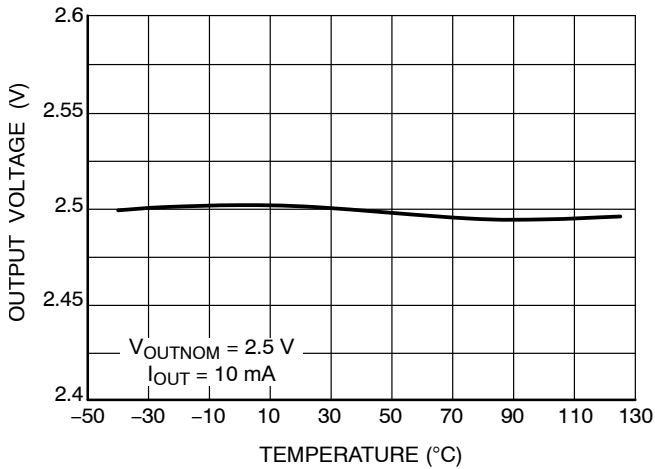

Figure 16. Output Voltage vs. Temperature

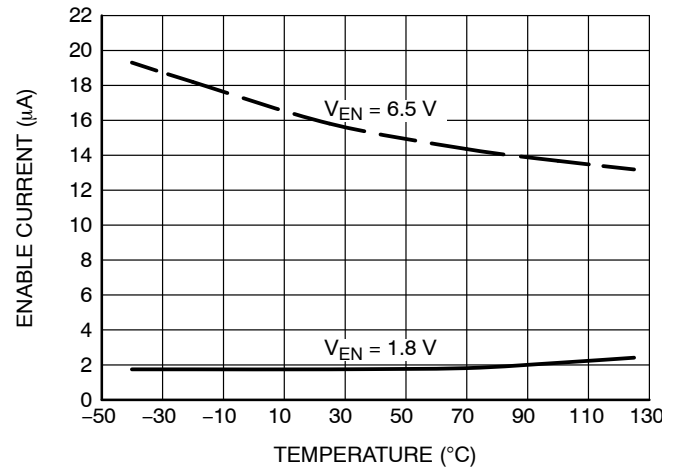

Figure 17. Enable Pin Input Current vs. Temperature

NCP59302, NCV59302

FUNCTIONAL CHARACTERISTICS

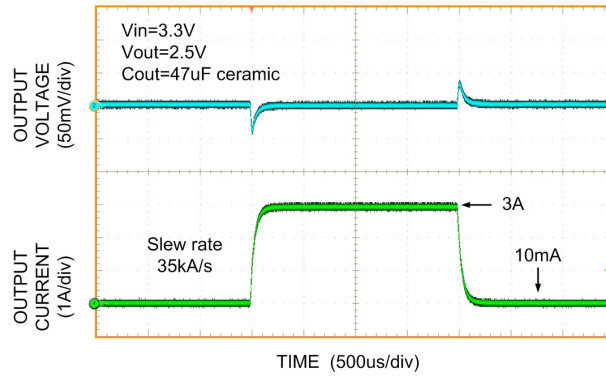

Figure 18. Load Transient Response

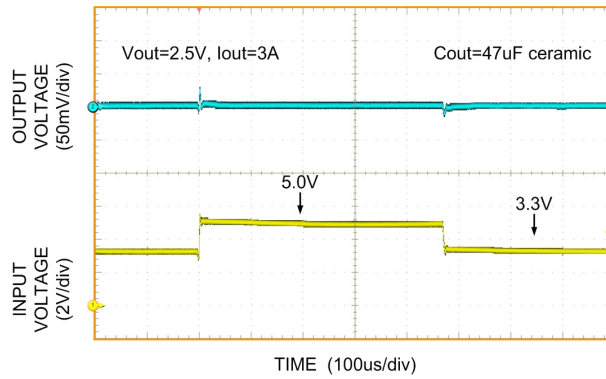

Figure 19. Line Transient Response

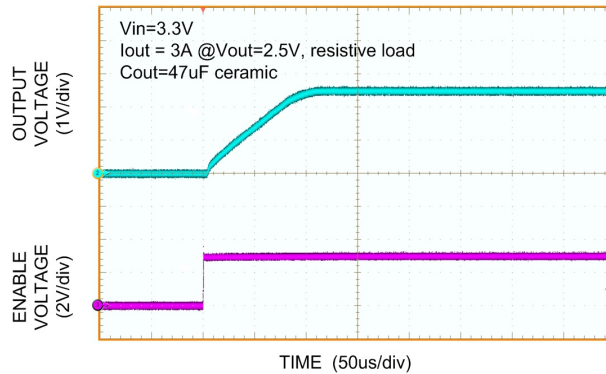

Figure 20. Enable Transient Response

APPLICATIONS INFORMATION

Output Capacitor and Stability

The NCP59302 device requires an output capacitor for stable operation. The NCP59302 is designed to operate with ceramic output capacitors. The recommended output capacitance value is 47 μF or greater. Such capacitors help to improve transient response and noise reduction at high frequency.

Input Capacitor

An input capacitor of 1.0 μF or greater is recommended when the device is more than 4 inches away from the bulk supply capacitance, or when the supply is a battery. Small, surface-mount chip capacitors can be used for the bypassing. The capacitor should be placed within 1 inch of the device for optimal performance. Larger values will help to improve ripple rejection by bypassing the input of the regulator, further improving the integrity of the output voltage.

Minimum Load Current

The NCP59302 regulator is specified between finite loads. A 10 mA minimum load current is necessary for proper operation.

Enable Input

NCP59302 regulators also feature an enable input for on/off control of the device. Its shutdown state draws “zero” current from input voltage supply (only microamperes of leakage). The enable input is TTL/CMOS compatible for simple logic interface, but can be connected up to V_{IN}.

Overcurrent and Reverse Output Current Protection

The NCP59302 regulator is fully protected from damage due to output current overload conditions. When NCP59302 output is overloaded, Output Current limiting is provided. This limiting is linear; output current during overload conditions is constant. The device is also capable to withstand power-on or enable start-up with output shorted to ground for the full Recommended Operating Conditions range. These features are advantageous for powering FPGAs and other ICs having current consumption higher than nominal during their startup.

Thermal shutdown disables the NCP59302 device when the die temperature exceeds the maximum safe operating temperature.

When NCP59302 is disabled and (V_{OUT} – V_{IN}) voltage difference is less than 6.5 V in the application, the output structure of these regulators is able to withstand output voltage (backup battery as example) to be applied without reverse current flow.

Adjustable Voltage Design

The NCP/NCV59302 Adjustable voltage Device Output voltage is set by the ratio of two external resistors as shown in Figure 21.

The device maintains the voltage at the ADJ pin at 1.24 V referenced to ground. The current in R2 is then equal to 1.24 V / R2, and the current in R1 is the current in R2 plus the ADJ pin bias current. The ADJ pin bias current flows from V_{OUT} through R1 into the ADJ pin.

The output voltage can be calculated using the formula shown in Figure 21.

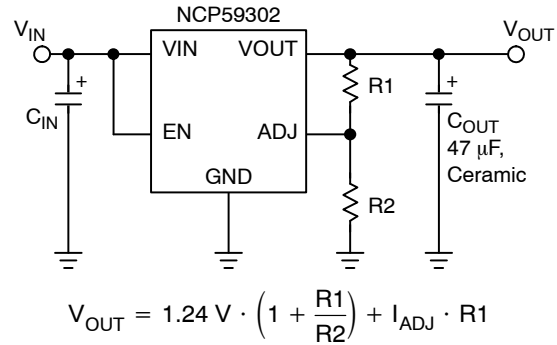

Figure 21. Adjustable Voltage Operation

Thermal Considerations

The power handling capability of the device is limited by the maximum rated junction temperature (125 °C). The P_D total power dissipated by the device has two components, Input to output voltage differential multiplied by Output current and Input voltage multiplied by GND pin current.

$$P_D = (V_{IN} - V_{OUT}) \cdot I_{OUT} + V_{IN} \cdot I_{GND} \quad (\text{eq. 1})$$

The GND pin current value can be found in Electrical Characteristics table and in Typical Characteristics graphs.

The Junction temperature T_J is

$$T_J = T_A + P_D \cdot R_{\theta JA} \quad (\text{eq. 2})$$

where T_A is ambient temperature and R_{θJA} is the Junction to Ambient Thermal Resistance of the NCP/NCV59302 device mounted on the specific PCB.

To maximize efficiency of the application and minimize thermal power dissipation of the device it is convenient to use the Input to output voltage differential as low as possible.

The static typical dropout characteristics for various output voltage and output current can be found in the Typical Characteristics graphs.

NCP59302, NCV59302

ORDERING INFORMATION

| Device | Output Current | Output Voltage | Junction Temp. Range | Package | Shipping [†] |
|------------------|----------------|----------------|----------------------|-------------------|-----------------------|
| NCP59302DSADJR4G | 3.0 A | ADJ | -40 °C to +125 °C | D2PAK-5 (Pb-Free) | 800 / Tape & Reel |

DISCONTINUED (Note 10)

| | | | | | |
|-------------------|-------|-----|-------------------|-------------------|-------------------|
| NCV59302DSADJR4G* | 3.0 A | ADJ | -40 °C to +125 °C | D2PAK-5 (Pb-Free) | 800 / Tape & Reel |
|-------------------|-------|-----|-------------------|-------------------|-------------------|

† For information on tape and reel specifications, including part orientation and tape sizes, please refer to our Tape and Reel Packaging Specifications Brochure, [BRD8011/D](#).

* NCV Prefix for Automotive and Other Applications Requiring Unique Site and Control Change Requirements; AEC-Q100 Qualified and PPAP Capable.

10. **DISCONTINUED:** This device is not available. Please contact your **onsemi** representative for information. The most current information on this device may be available on www.onsemi.com.

NCP59302, NCV59302

REVISION HISTORY

| Revision | Description of Changes | Date |
|----------|---|------------|
| 3 | NCV59302DSADJR4G OPN Marked as Discontinued + Rebranded the Data Sheet to onsemi format. | 01/28/2026 |

This document has undergone updates prior to the inclusion of this revision history table. The changes tracked here only reflect updates made on the noted approval dates.

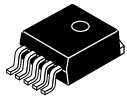

D²PAK 5-LEAD
CASE 936A-02
ISSUE E

DATE 28 JUL 2021

SCALE 1:1

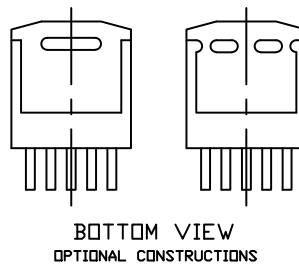
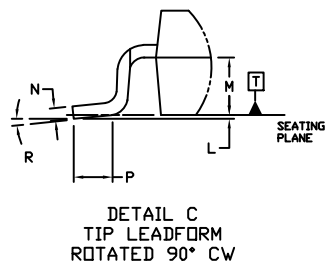
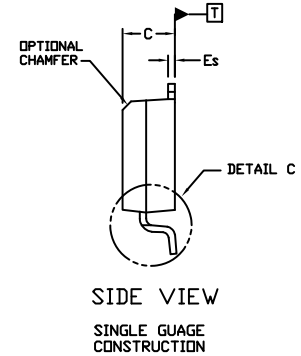
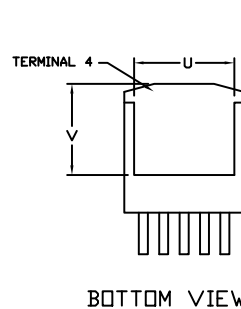
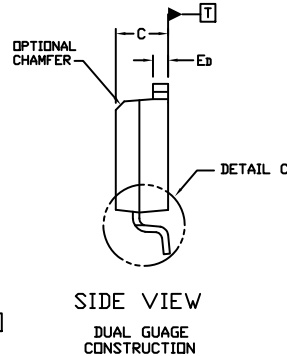
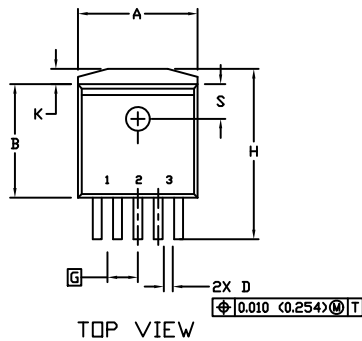

NOTES:

1. DIMENSIONING AND TOLERANCING PER ANSI Y14.5M, 1982.
2. CONTROLLING DIMENSION INCHES
3. TAB CONTOUR OPTIONAL WITHIN DIMENSIONS A AND K.
4. DIMENSIONS U AND V ESTABLISH A MINIMUM MOUNTING SURFACE FOR TERMINAL 4.
5. DIMENSIONS A AND B DO NOT INCLUDE MOLD FLASH OR GATE PROTRUSIONS. MOLD FLASH AND GATE PROTRUSIONS NOT TO EXCEED 0.025 (0.635) MAXIMUM.

| DIM | INCHES | | MILLIMETERS | |
|-----|--------|-------|-------------|--------|
| | MIN. | MAX. | MIN. | MAX. |
| A | 0.396 | 0.403 | 9.804 | 10.236 |
| B | 0.356 | 0.368 | 9.042 | 9.347 |
| C | 0.170 | 0.180 | 4.318 | 4.572 |
| D | 0.026 | 0.036 | 0.660 | 0.914 |
| Ed | 0.045 | 0.055 | 1.143 | 1.397 |
| Es | 0.018 | 0.026 | 0.457 | 0.660 |
| G | 0.067 | BSC | 1.702 | BSC |
| H | 0.539 | 0.579 | 13.691 | 14.707 |
| K | 0.050 | REF | 1.270 | REF |
| L | 0.000 | 0.010 | 0.000 | 0.254 |
| M | 0.088 | 0.102 | 2.235 | 2.591 |
| N | 0.018 | 0.026 | 0.457 | 0.660 |
| P | 0.058 | 0.078 | 1.473 | 1.981 |
| R | 0° | 8° | 0° | 8° |
| S | 0.116 | REF | 2.946 | REF |
| U | 0.200 | MIN | 5.080 | MIN |
| V | 0.250 | MIN | 6.350 | MIN |

GENERIC
MARKING DIAGRAM*

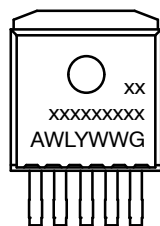

- xxxxxx = Device Code
- A = Assembly Location
- WL = Wafer Lot
- Y = Year
- WW = Work Week
- G = Pb-Free Package

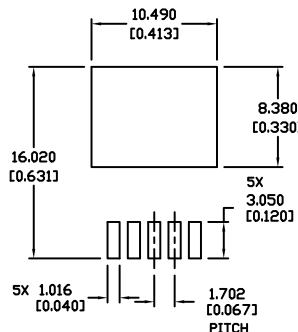

* For additional information on our Pb-Free strategy and soldering details, please download the ON Semiconductor Soldering and Mounting Techniques Reference Manual, SOLDERRM/D.

*This information is generic. Please refer to device data sheet for actual part marking. Pb-Free indicator, "G" or microdot "μ", may or may not be present. Some products may not follow the Generic Marking.

| | | |
|------------------|--------------|--|
| DOCUMENT NUMBER: | 98ASH01006A | Electronic versions are uncontrolled except when accessed directly from the Document Repository. Printed versions are uncontrolled except when stamped "CONTROLLED COPY" in red. |
| DESCRIPTION: | D2PAK 5-LEAD | PAGE 1 OF 1 |

onsemi and ONSEMI are trademarks of Semiconductor Components Industries, LLC dba onsemi or its subsidiaries in the United States and/or other countries. onsemi reserves the right to make changes without further notice to any products herein. onsemi makes no warranty, representation or guarantee regarding the suitability of its products for any particular purpose, nor does onsemi assume any liability arising out of the application or use of any product or circuit, and specifically disclaims any and all liability, including without limitation special, consequential or incidental damages. onsemi does not convey any license under its patent rights nor the rights of others.

onsemi, **Onsemi**, and other names, marks, and brands are registered and/or common law trademarks of Semiconductor Components Industries, LLC dba "**onsemi**" or its affiliates and/or subsidiaries in the United States and/or other countries. **onsemi** owns the rights to a number of patents, trademarks, copyrights, trade secrets, and other intellectual property. A listing of **onsemi**'s product/patent coverage may be accessed at www.onsemi.com/site/pdf/Patent-Marking.pdf. **onsemi** reserves the right to make changes at any time to any products or information herein, without notice. The information herein is provided "as-is" and **onsemi** makes no warranty, representation or guarantee regarding the accuracy of the information, product features, availability, functionality, or suitability of its products for any particular purpose, nor does **onsemi** assume any liability arising out of the application or use of any product or circuit, and specifically disclaims any and all liability, including without limitation special, consequential or incidental damages. Buyer is responsible for its products and applications using **onsemi** products, including compliance with all laws, regulations and safety requirements or standards, regardless of any support or applications information provided by **onsemi**. "Typical" parameters which may be provided in **onsemi** data sheets and/or specifications can and do vary in different applications and actual performance may vary over time. All operating parameters, including "Typicals" must be validated for each customer application by customer's technical experts. **onsemi** does not convey any license under any of its intellectual property rights nor the rights of others. **onsemi** products are not designed, intended, or authorized for use as a critical component in life support systems or any FDA Class 3 medical devices or medical devices with a same or similar classification in a foreign jurisdiction or any devices intended for implantation in the human body. Should Buyer purchase or use **onsemi** products for any such unintended or unauthorized application, Buyer shall indemnify and hold **onsemi** and its officers, employees, subsidiaries, affiliates, and distributors harmless against all claims, costs, damages, and expenses, and reasonable attorney fees arising out of, directly or indirectly, any claim of personal injury or death associated with such unintended or unauthorized use, even if such claim alleges that **onsemi** was negligent regarding the design or manufacture of the part. **onsemi** is an Equal Opportunity/Affirmative Action Employer. This literature is subject to all applicable copyright laws and is not for resale in any manner.

ADDITIONAL INFORMATION

TECHNICAL PUBLICATIONS:

Technical Library: www.onsemi.com/design/resources/technical-documentation
onsemi Website: www.onsemi.com

ONLINE SUPPORT: www.onsemi.com/support

For additional information, please contact your local Sales Representative at www.onsemi.com/support/sales