

Current-Shunt Monitors, Zero-Drift, 40 V Common Mode, Bidirectional, Shutdown

NCS21671, NCV21671

The NCS21671 and NCV21671 are a series of voltage output current sense amplifiers offered in gains of 25, 50, 100, and 200 V/V. These parts can measure voltage across shunts at common mode voltages from -0.1 V to 40 V, independent of supply voltage. The low offset of the zero-drift architecture enables current sensing with voltage drops across sense resistors as low as 10 mV full-scale. An optional enable function is available to reduce current drain through the input pins and power supply pins to negligible levels when disabled or if V_S is less than 1.5 V. Two optional pins are included to simplify input filtering. These devices can operate from a single +1.8 V to +5.5 V power supply, drawing a maximum of 80 μ A of supply current. These parts are available in Micro10 and SC70-6 packages.

Features

- Wide Common Mode Input Range: -0.1 V to 40 V
- Supply Voltage Range: 1.8 V to 5.5 V
- Low Offset Voltage: $\pm 25 \mu$ V max
- Rail-to-Rail Output Capability
- Low Current Consumption: 80 μ A max
- Enable Pin to Turn Off Input and Power Supply Currents
- Optional Input Filtering Through C_{IN+} and C_{IN-} Pins
- NCV Prefix for Automotive and Other Applications Requiring Unique Site and Control Change Requirements; AEC-Q100 Qualified and PPAP Capable
- These Devices are Pb-Free, Halogen Free/BFR Free and are RoHS Compliant

Typical Applications

- Power Bus Monitoring
- Battery Current Monitor
- Lighting Ballast

MARKING DIAGRAMS

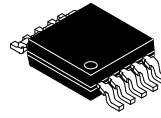

Micro10
 CASE 846B-03

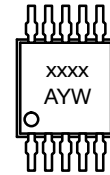

XXXX = Device Code
 A = Assembly Location
 Y = Year
 W = Work Week
 ■ = Pb-Free Package

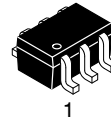

SC-88/SC70-6
 /SOT-363
 CASE 419B-02

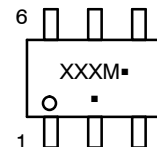

XXX = Specific Device Code
 M = Date Code*
 ■ = Pb-Free Package

(Note: Microdot may be in either location)

PIN CONNECTIONS

See pin connections on page 2 of this datasheet.

ORDERING INFORMATION

See detailed ordering and shipping information in the package dimensions section on page 14 of this data sheet.

NCS21671, NCV21671

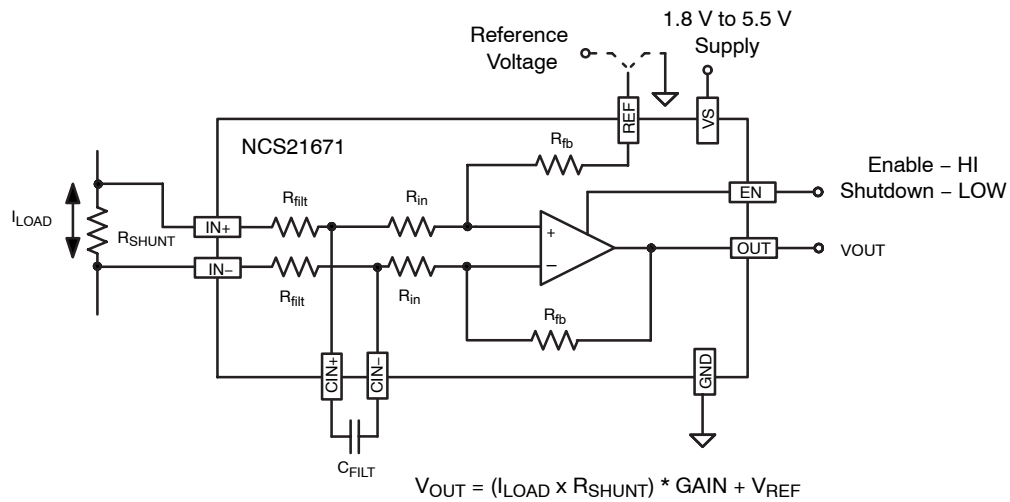

Figure 1. Example Application Schematic of High-Side Current Sensing

PIN FUNCTION DESCRIPTION

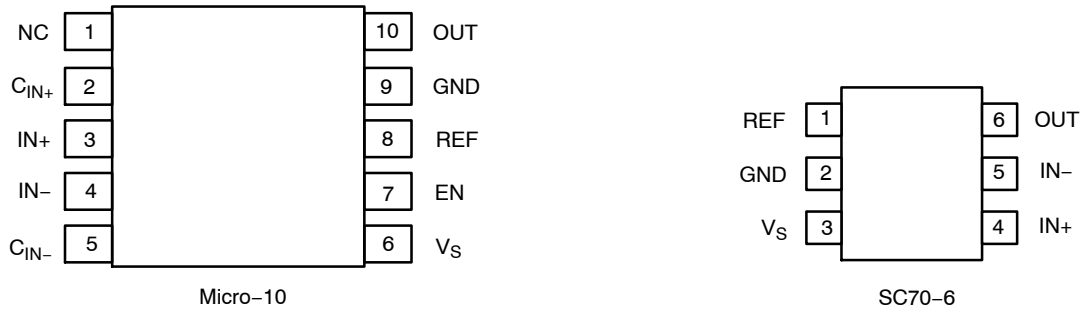

Figure 2. Pin Function Description

PIN DESCRIPTION

Pin Name	Type	Description
NC	No connect	This pin must be left not connected to external circuitry.
C _{IN+}	Input	Available on Micro10 packages only. An optional capacitor can be added between C _{IN+} and C _{IN-} to create a low-pass input filter.
IN+	Input	This pin is connected to the positive side of the sense resistor or current shunt. This pin becomes high impedance when the part is in shutdown mode (EN = 0).
IN-	Input	This pin is connected to the negative side of the sense resistor or current shunt. This pin becomes high impedance when the part is in shutdown mode (EN = 0).
C _{IN-}	Input	Available on Micro10 packages only. An optional capacitor can be added between C _{IN+} and C _{IN-} to create a low-pass input filter.
V _S	Supply	This is the positive supply pin that provides power to the internal circuitry. An external bypass capacitor of 0.1 μF is recommended to be placed as close as possible to this pin.
EN	Input	Available on Micro10 packages only. There is no pull-up enable the part when this pin is open circuit. The enable pin can be connected to V _S or driven with a logic level to enable the part. If this pin is driven low the part enters a low power mode to conserve current consumption.
REF	Input	This pin sets the reference voltage of the internal difference amplifier circuit, allowing for unidirectional or bidirectional current sensing. For unidirectional current sensing, connect this pin to GND. For bidirectional current sensing, connect this pin between the GND and V _S range.
GND	Supply	This is the negative supply rail of the circuit.
OUT	Output	The output pin provides a low impedance voltage output. This pin becomes high impedance when the part is in shutdown mode (EN = 0).

NCS21671, NCV21671

MAXIMUM RATINGS

Parameter		Symbol	Rating	Unit
Supply Voltage (Note 1)		V_S	-0.3 to 6	V
IN+, IN-, CIN+, CIN-	Differential ($V_{IN+} - V_{IN-}$) (Note 2)	V_{IN+}, V_{IN-}	44	V
	Common-Mode (Note 2)		-0.3 to +44	
REF Input		V_{REF}	GND-0.3 to (V_S) +0.3	V
EN Input		V_{EN}	GND-0.3 to (V_S) +0.3	V
Output (Note 2)		V_{OUT}	GND-0.3 to (V_S) +0.3	V
Input Current into Any Pin (Note 2)		I_{IN}	± 10	mA
Operating Temperature		T_A	-40 to +150	$^{\circ}\text{C}$
Storage Temperature		T_{STG}	-65 to +150	$^{\circ}\text{C}$
Junction Temperature		$T_{J(max)}$	+150	$^{\circ}\text{C}$
ESD Capability, Human Body Model (Note 3)		HBM	± 2000	V
Charged Device Model (Note 3)		CDM	± 1000	V
Latch-up Current (Note 4)			± 100	mA

Stresses exceeding those listed in the Maximum Ratings table may damage the device. If any of these limits are exceeded, device functionality should not be assumed, damage may occur and reliability may be affected.

1. Refer to ELECTRICAL CHARACTERISTICS, RECOMMENDED OPERATING RANGES and/or APPLICATION INFORMATION for safe operating parameters.
2. Input voltage at any pin may exceed the voltage shown if current at that pin is limited to ± 10 mA.
3. This device series incorporates ESD protection and is tested by the following methods:
ESD Human Body Model tested per JEDEC standard JS-001-2017
ESD Charged Device Model tested per JEDEC standard JS-002-2014
4. Latch-up Current tested per JEDEC standard JESD78E

THERMAL CHARACTERISTICS

Parameter	Symbol	Micro10 / MSOP10	SC88 / SC70-6 / SOT-363	Unit
Junction-to-ambient thermal resistance (Notes 5, 6)	θ_{JA}	180	188	$^{\circ}\text{C}/\text{W}$
Junction-to-case thermal resistance (Notes 5, 6)	$\theta_{JC(top)}$	71	128	$^{\circ}\text{C}/\text{W}$
Junction-to-top thermal characterization (Notes 5, 6)	Ψ_{JT}	1.6	21	$^{\circ}\text{C}/\text{W}$
Junction-to-board thermal characterization (Notes 5, 6)	Ψ_{JB}	98	91	$^{\circ}\text{C}/\text{W}$

5. Refer to ELECTRICAL CHARACTERISTICS, RECOMMENDED OPERATING RANGES and/or APPLICATION INFORMATION for safe operating parameters.
6. Values based on copper area of 645 mm² (or 1 in²) of 1 oz copper thickness and FR4 PCB substrate. (reference JESD51).

RECOMMENDED OPERATING RANGES

Parameter	Symbol	Conditions	Min	Max	Unit
Operating Temperature	T_A	NCS prefix	-40	125	$^{\circ}\text{C}$
		NCV prefix	-40	125	
Common Mode Input Voltage	V_{CM}	Full temperature range	-0.1	40	V
Supply Voltage	V_S	Full temperature range	1.8	5.5	V

Functional operation above the stresses listed in the Recommended Operating Ranges is not implied. Extended exposure to stresses beyond the Recommended Operating Ranges limits may affect device reliability.

NCS21671, NCV21671

ELECTRICAL CHARACTERISTICS

At $T_A = +25^\circ\text{C}$, $V_{\text{SENSE}} = (V_{\text{IN}+}) - (V_{\text{IN}-})$; $V_S = 1.8\text{ V to }5.5\text{ V}$, $V_{\text{IN}+} = 12\text{ V}$, and $V_{\text{REF}} = V_S/2$, unless otherwise noted. **Boldface** limits apply over the specified temperature range, $T_A = -40^\circ\text{C to }125^\circ\text{C}$.

Parameter	Symbol	Conditions	Min	Typ	Max	Unit	
INPUT							
Common Mode Rejection Ratio, RTI (Note 7)	CMRR	$V_{\text{IN}+} = -0.1\text{ V to }40\text{ V}$, $V_{\text{SENSE}} = 0\text{ mV}$ $T_A = -40^\circ\text{C to }125^\circ\text{C}$	G = 25	109	127	-	dB
			G = 50	109	127	-	
			G = 100	109	134	-	
			G = 200	109	134	-	
Input Offset Voltage, RTI (Note 7)	V _{OS}	$V_{\text{SENSE}} = 0\text{ mV}$	G = 25	-	±9	±19	μV
			G = 50	-	±4	±12	
			G = 100	-	±3	±10	
			G = 200	-	±2	±10	
		$V_{\text{IN}+} = -0.1\text{ V to }40\text{ V}$ $V_{\text{SENSE}} = 0\text{ mV}$	G = 25	-	±1	±60	μV
			G = 50	-	±1	±40	
			G = 100	-	±1	±25	
			G = 200	-	±1	±25	
Input Offset Voltage Drift vs. Temperature, RTI (Note 7)	DV _{OS} / dT	$V_{\text{SENSE}} = 0\text{ mV}$	-	±0.1	±0.5	μV/°C	
Power Supply Rejection Ratio	PSRR	$V_S = 1.8\text{ V to }5.5\text{ V}$, $V_{\text{SENSE}} = 0\text{ mV}$	-	±1.0	±10	μV/V	
Input Bias Current	I _{IB}	$V_{\text{SENSE}} = 0\text{ mV}$	-	29	35	μA	
Input Bias Current in Shutdown (Note 10)	I _{IBSD}	$V_{\text{SENSE}} = 0\text{ mV}$	-	-	140	nA	
Input Bias Current in Shutdown (Note 10)	I _{IBSD}	$T_A = -40^\circ\text{C to }125^\circ\text{C}$	-	-	500	nA	
Input Offset Current	I _{IO}	$V_{\text{SENSE}} = 0\text{ mV}$	-	±0.3	-	μA	
Enable Input Threshold Voltage	V _{th(EN)}	Enabled	1.4	-	-	V	
		Disabled	-	-	0.3		
Enable Input Leakage Current	I _{EN}	$V_{\text{EN}} = V_S$	-	3	-	nA	
		$V_{\text{EN}} = \text{GND}$	-	-3	-		
Enable Time (Note 8)	t _{ON}	R _L = 10 kΩ to GND	-	65	-	μs	
Shutdown Time (Note 8)	t _{OFF}	R _L = 10 kΩ to GND	-	20	-	μs	
OUTPUT							
Gain	G		G = 25	-	25	-	V/V
			G = 50	-	50	-	
			G = 100	-	100	-	
			G = 200	-	200	-	
Gain Error	E _G	$V_{\text{SENSE}} = -5\text{ mV to }+5\text{ mV}$, $T_A = -40^\circ\text{C to }125^\circ\text{C}$	G = 25	-	-	±0.4	%
			G = 50	-	-	±0.4	
			G = 100	-	-	±0.3	
			G = 200	-	-	±0.5	
Nonlinearity Error			-	±0.01	-	%	
Reference Voltage Rejection Ratio (Note 10)	RVRR	$V_{\text{REF}} = 100\text{ mV to } (V_S - 100\text{ mV})$ $T_A = -40^\circ\text{C to }125^\circ\text{C}$ $V_S = 5.5\text{ V}$	G = 25	-	-	27	μV/V
			G = 50	-	-	15	
			G = 100	-	-	10	
			G = 200	-	-	10	
Maximum Capacitive Load	C _L	No sustained oscillation	-	1	-	nF	

NCS21671, NCV21671

ELECTRICAL CHARACTERISTICS

At $T_A = +25^\circ\text{C}$, $V_{\text{SENSE}} = (V_{\text{IN}+}) - (V_{\text{IN}-})$; $V_S = 1.8\text{ V to }5.5\text{ V}$, $V_{\text{IN}+} = 12\text{ V}$, and $V_{\text{REF}} = V_S/2$, unless otherwise noted. **Boldface** limits apply over the specified temperature range, $T_A = -40^\circ\text{C to }125^\circ\text{C}$.

Parameter	Symbol	Conditions	Min	Typ	Max	Unit
-----------	--------	------------	-----	-----	-----	------

VOLTAGE OUTPUT

Swing to V_S Supply Rail	V_{OH}	$R_L = 10\text{ k}\Omega$ to GND $T_A = -40^\circ\text{C to }+125^\circ\text{C}$	–	$V_S - 20$	$V_S - 35$	mV
Swing to GND	V_{OL}	$R_L = 10\text{ k}\Omega$ to GND $T_A = -40^\circ\text{C to }+125^\circ\text{C}$	–	1	2.5	mV

FREQUENCY RESPONSE

Bandwidth ($f_{-3\text{dB}}$)	BW	$C_L = 10\text{ pF}$	$G = 25$	–	40	–	kHz
			$G = 50$	–	40	–	
			$G = 100$	–	35	–	
			$G = 200$	–	20	–	
Slew Rate	SR	$V_S = 5.5\text{ V}$	–	0.3	–	V/ μs	
Settling Time	T_S	From current step to within 1% of final value	–	30	–	μs	

NOISE

Voltage Noise Density, RTI (Note 7)	e_n		$G = 25$	–	56	–	nV/ $\sqrt{\text{Hz}}$
			$G = 50$	–	46	–	
			$G = 100$	–	46	–	
			$G = 200$	–	46	–	

POWER SUPPLY

Quiescent Current	I_Q	$V_{\text{SENSE}} = 0\text{ mV}$	–	45	80	μA
Quiescent Current in Shutdown	I_{QSD}	$V_{\text{SENSE}} = 0\text{ mV}$	–	0.2	0.5	μA
Power-on Time (Note 9)	t_{PON}	$V_{\text{SENSE}} = 0\text{ mV}$	–	40	–	μs

Product parametric performance is indicated in the Electrical Characteristics for the listed test conditions, unless otherwise noted. Product performance may not be indicated by the Electrical Characteristics if operated under different conditions.

7. Referred to input.

8. Shutdown Time (t_{OFF}) and Enable Time (t_{ON}) are defined as the time between the 50% point of the signal applied to the EN pin and the point at which the output voltage reaches within 10% of its final value. $V_{\text{SENSE}} = (0.75 * V_S - V_{\text{REF}}) / \text{Gain}$.

9. Time between V_S is application and V_{out} reaching 10% of final value.

10. Guaranteed by characterization and/or design.

NCS21671, NCV21671

TYPICAL CHARACTERISTICS (At $T_A = +25^\circ\text{C}$, $V_{\text{SENSE}} = (V_{\text{IN}+}) - (V_{\text{IN}-})$; $V_S = V_{\text{EN}} = 1.8\text{ V}$, $V_{\text{REF}} = V_S/2$, $V_{\text{CM}} = 12\text{ V}$, and all gains unless otherwise noted.)

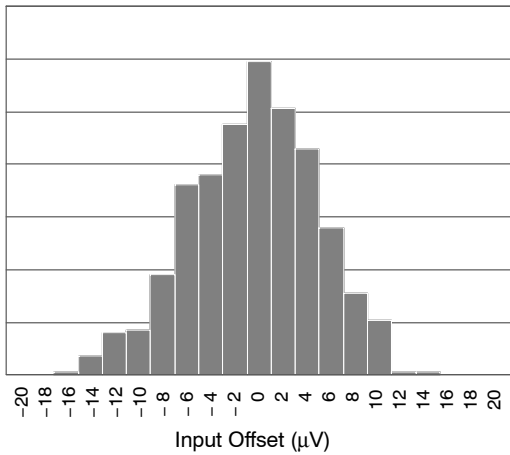

Figure 3a. Input Offset Voltage Distribution, G25

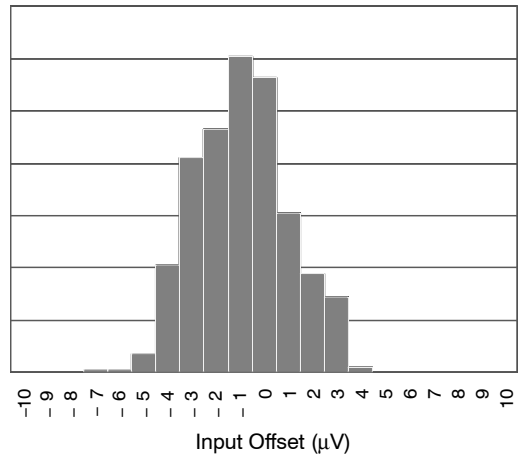

Figure 3b. Input Offset Voltage Distribution, G50

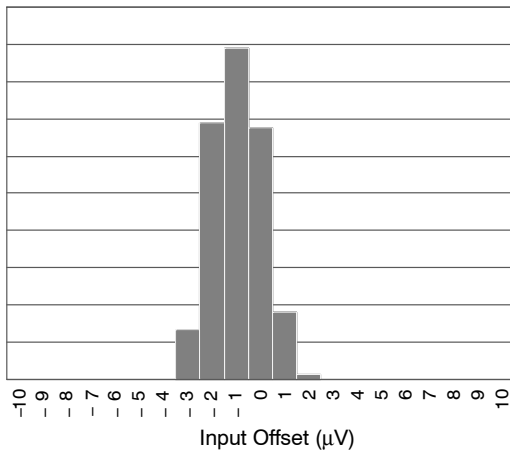

Figure 3c. Input Offset Voltage Distribution, G100

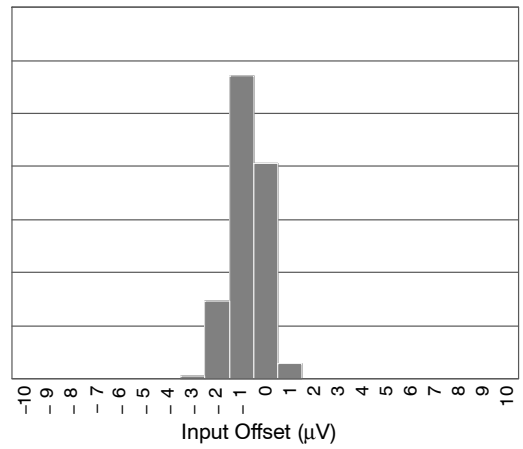

Figure 3d. Input Offset Voltage Distribution, G200

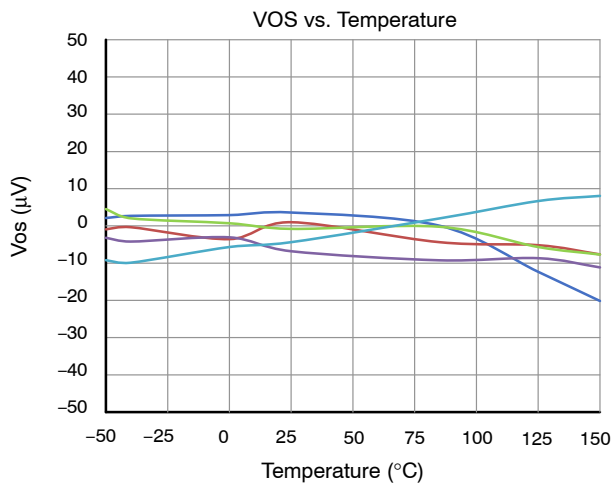

Figure 5. Input Offset vs. Temperature, G100

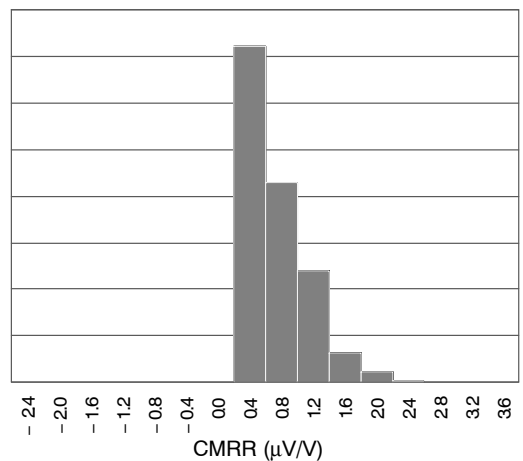

Figure 5a. Common Mode Rejection Ratio Distribution, G25

NCS21671, NCV21671

TYPICAL CHARACTERISTICS (At $T_A = +25^\circ\text{C}$, $V_{\text{SENSE}} = (V_{\text{IN}+}) - (V_{\text{IN}-})$; $V_S = V_{\text{EN}} = 1.8\text{ V}$, $V_{\text{REF}} = V_S/2$, $V_{\text{CM}} = 12\text{ V}$, and all gains unless otherwise noted.) (continued)

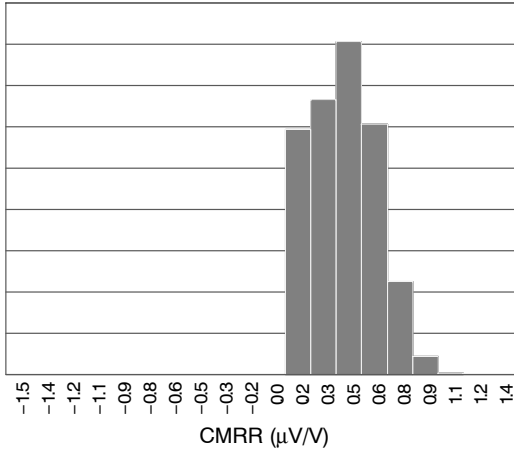

Figure 5b. Common Mode Rejection Ratio Distribution, G50

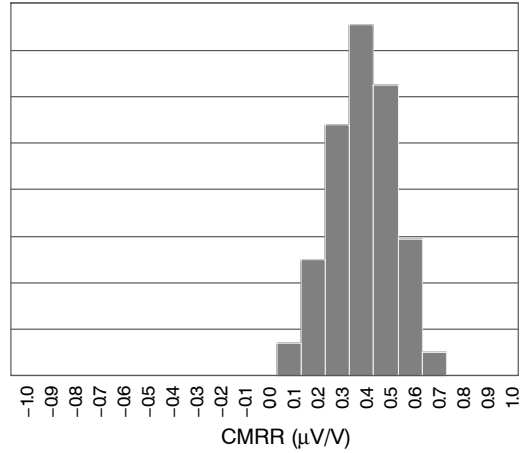

Figure 5c. Common Mode Rejection Ratio Distribution, G100

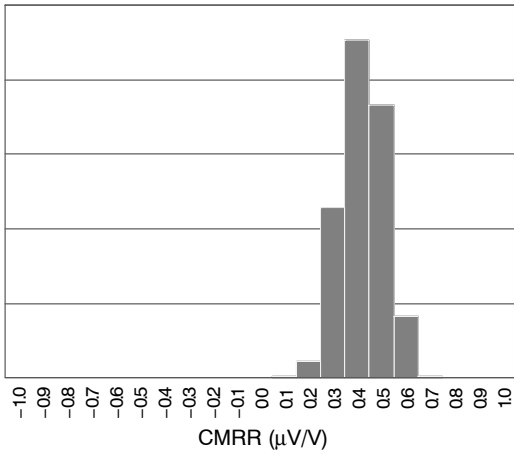

Figure 5d. Common Mode Rejection Ratio Distribution, G200

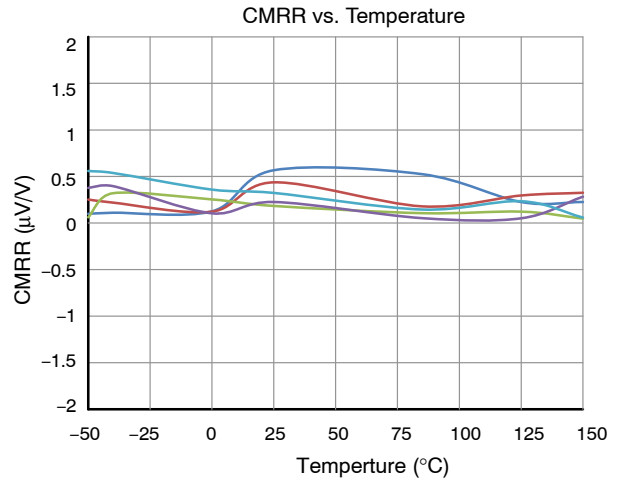

Figure 6. Common Mode Rejection Ratio vs Temperature, G100

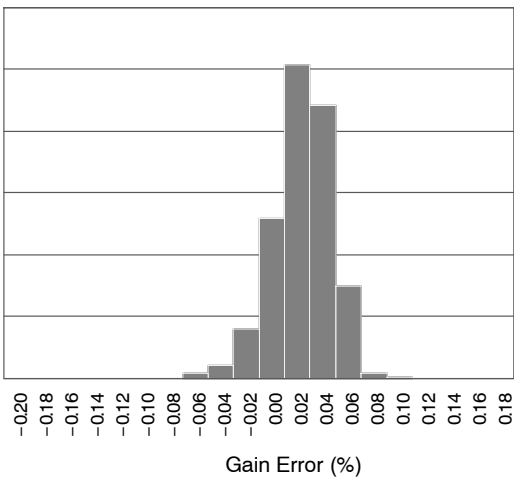

Figure 7a. Gain Error Distribution, G25

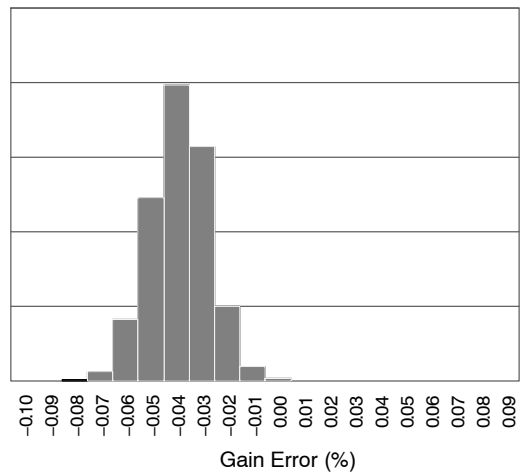

Figure 7b. Gain Error Distribution, G50

NCS21671, NCV21671

TYPICAL CHARACTERISTICS (At $T_A = +25^\circ\text{C}$, $V_{\text{SENSE}} = (V_{\text{IN}+}) - (V_{\text{IN}-})$; $V_S = V_{\text{EN}} = 1.8\text{ V}$, $V_{\text{REF}} = V_S/2$, $V_{\text{CM}} = 12\text{ V}$, and all gains unless otherwise noted.) (continued)

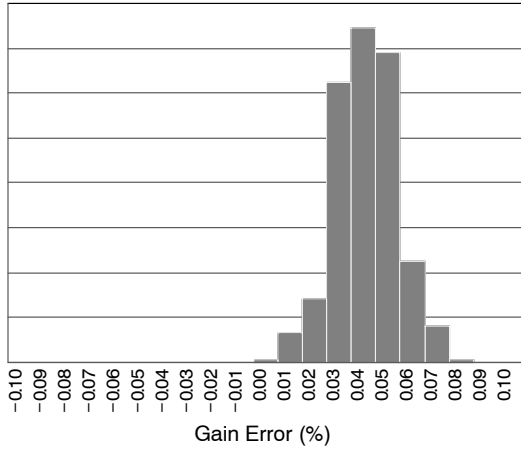

Figure 7c. Gain Error Distribution, G100

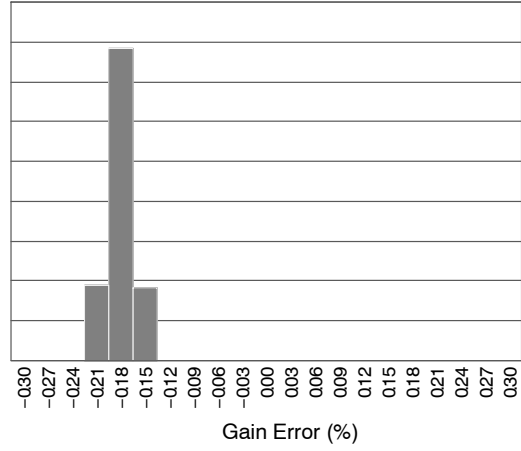

Figure 7d. Gain Error Distribution, G200

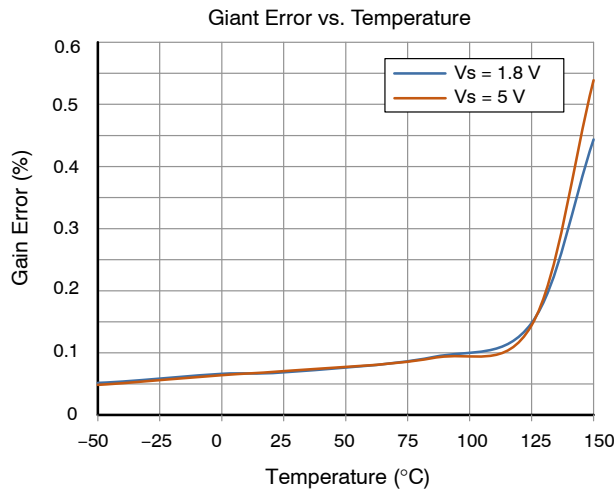

Figure 8. Gain Error vs Temperature, G100

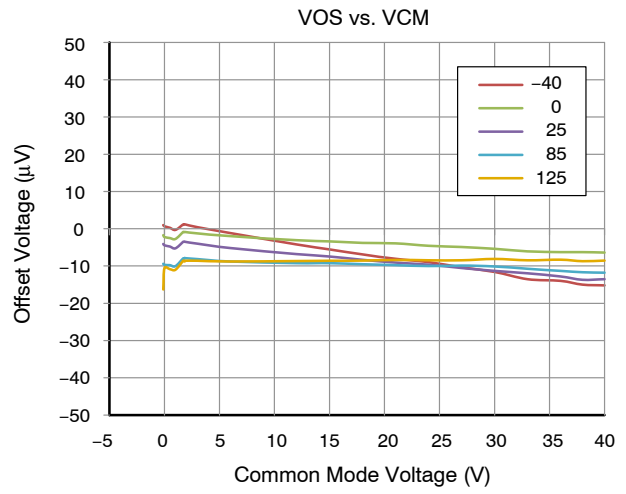

Figure 9. Zero VIN Output vs Common Mode Voltage, G100

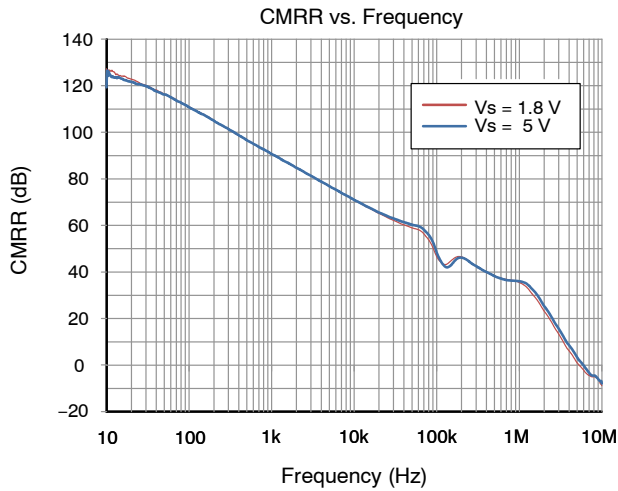

Figure 10. Common Mode Rejection Ratio vs Frequency, G100

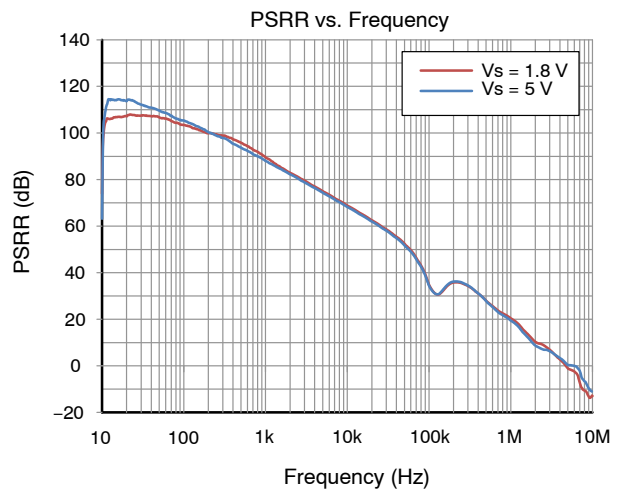

Figure 11. Power Supply Rejection Ratio vs Frequency, G100

TYPICAL CHARACTERISTICS (At $T_A = +25^\circ\text{C}$, $V_{\text{SENSE}} = (V_{\text{IN}+}) - (V_{\text{IN}-})$; $V_S = V_{\text{EN}} = 1.8\text{ V}$, $V_{\text{REF}} = V_S/2$, $V_{\text{CM}} = 12\text{ V}$, and all gains unless otherwise noted.) (continued)

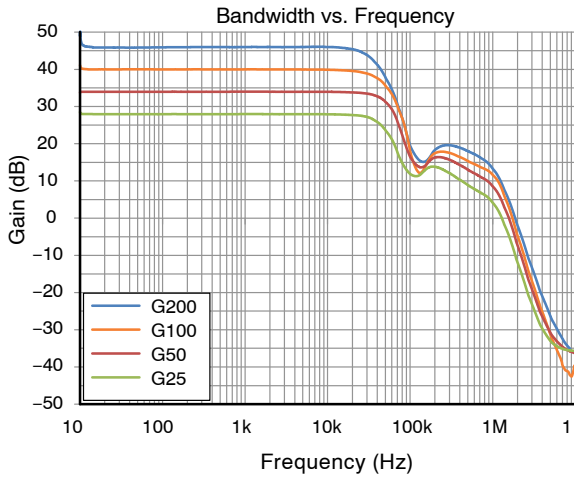

Figure 12. Gain vs Frequency

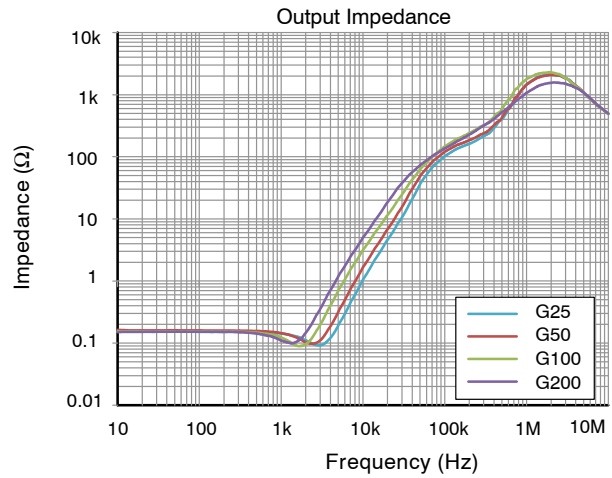

Figure 13. Output Impedance vs Frequency

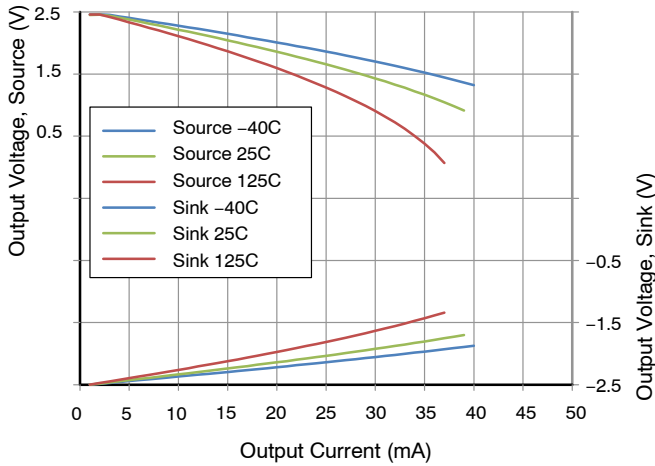

Figure 14. Output Voltage Swing vs Current

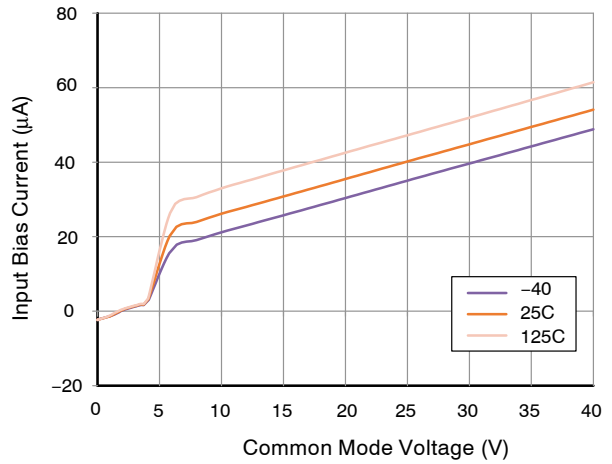

Figure 15. Input Bias Current vs Common Mode Voltage (Enabled)

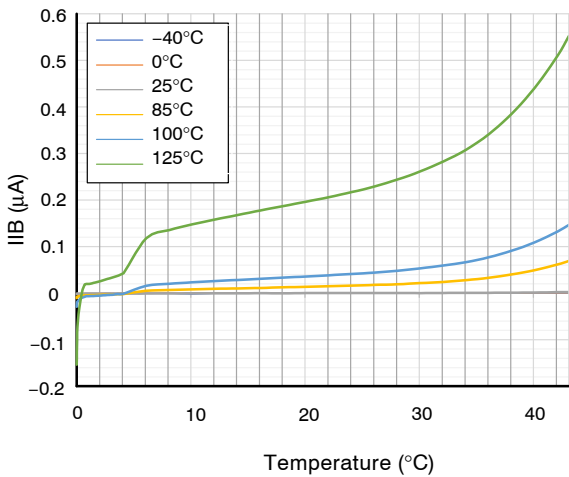

Figure 16. Input Bias Current vs Common Mode Voltage (VS open circuit)

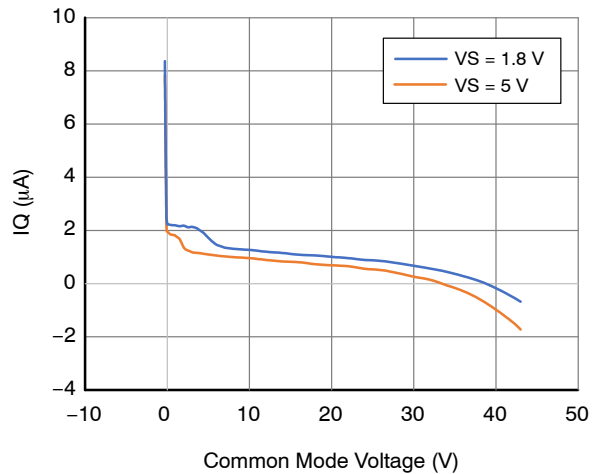

Figure 17. Quiescent Current vs Common Mode Voltage (Enabled)

NCS21671, NCV21671

TYPICAL CHARACTERISTICS (At $T_A = +25^\circ\text{C}$, $V_{\text{SENSE}} = (V_{\text{IN}+}) - (V_{\text{IN}-})$; $V_S = V_{\text{EN}} = 1.8\text{ V}$, $V_{\text{REF}} = V_S/2$, $V_{\text{CM}} = 12\text{ V}$, and all gains unless otherwise noted.) (continued)

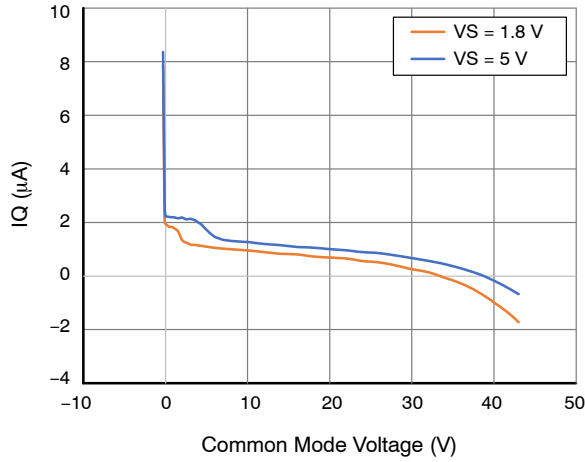

Figure 18. Quiescent Current vs Common Mode Voltage (Disabled)

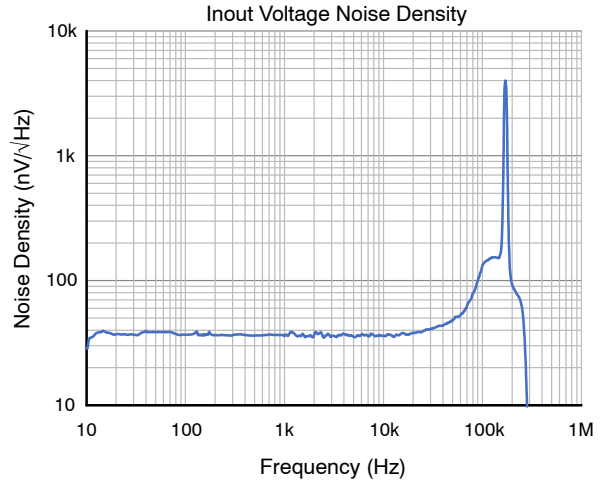

Figure 19. Voltage Noise Density (Referred-to-Input)

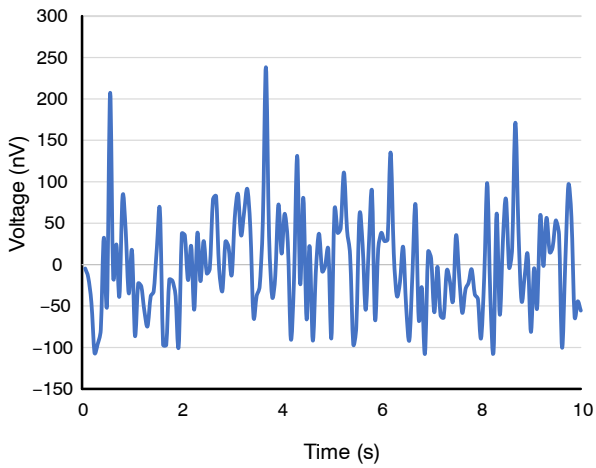

Figure 20. 0.1-Hz to 10-Hz Voltage Noise (Referred-to-Input)

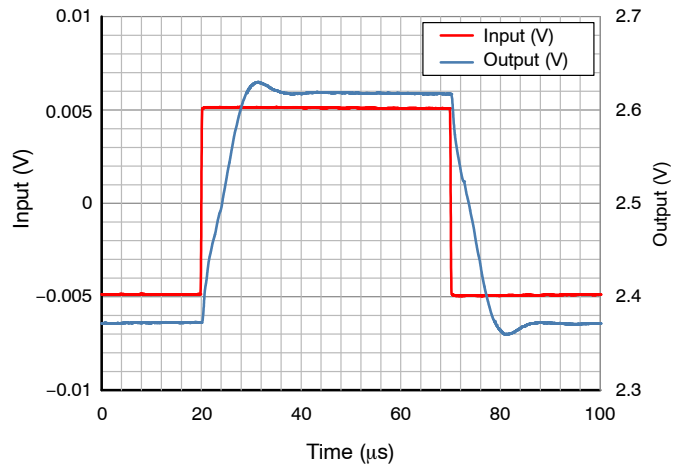

Figure 21. Step Response, G25 (10mV Input)

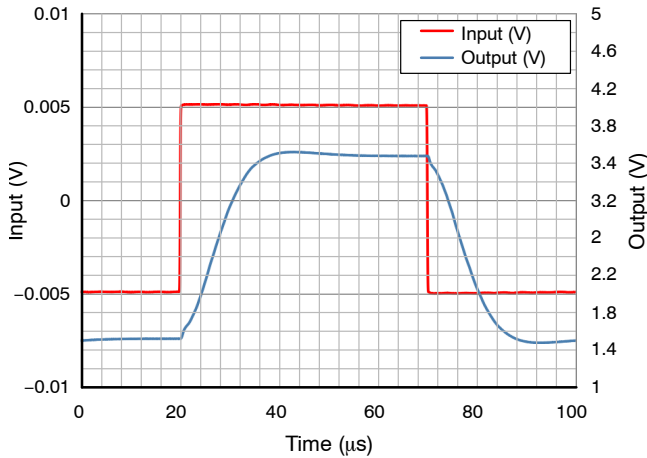

Figure 22. Step Response, G200 (10mV Input)

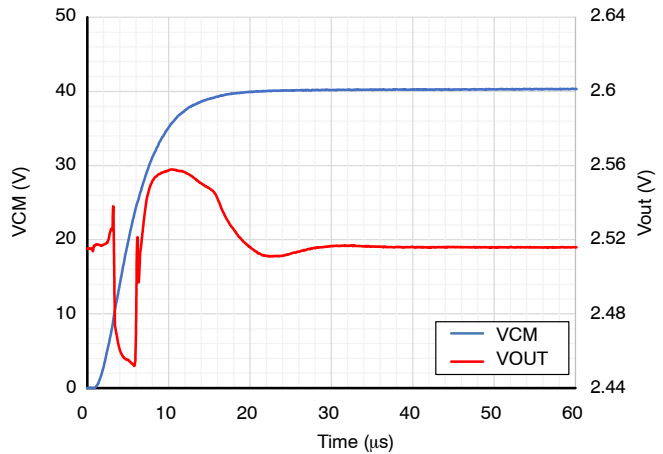

Figure 23a. Common Mode Voltage Step Rising, G100 (10µs)

NCS21671, NCV21671

TYPICAL CHARACTERISTICS (At $T_A = +25^\circ\text{C}$, $V_{\text{SENSE}} = (V_{\text{IN}+}) - (V_{\text{IN}-})$; $V_S = V_{\text{EN}} = 1.8\text{ V}$, $V_{\text{REF}} = V_S/2$, $V_{\text{CM}} = 12\text{ V}$, and all gains unless otherwise noted.) (continued)

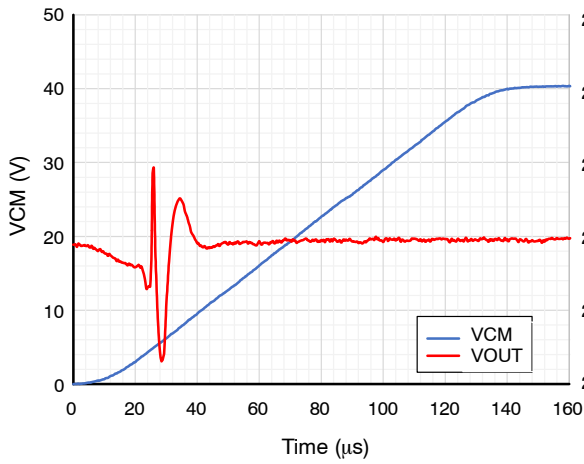

Figure 23b. Common Mode Voltage Step Rising, G100 (100µs)

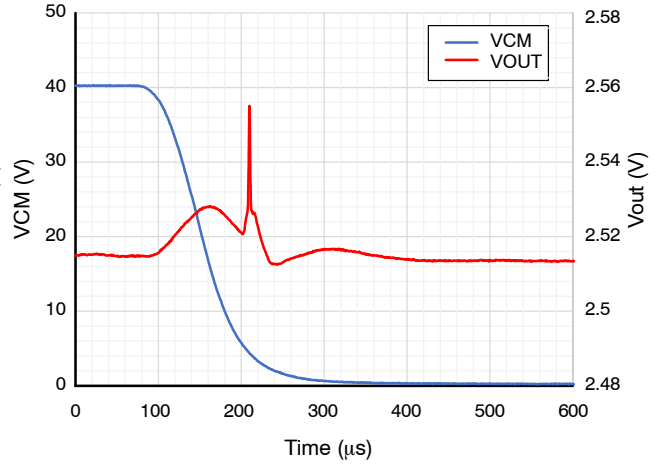

Figure 23c. Common Mode Voltage Step Falling, G100 (10µs)

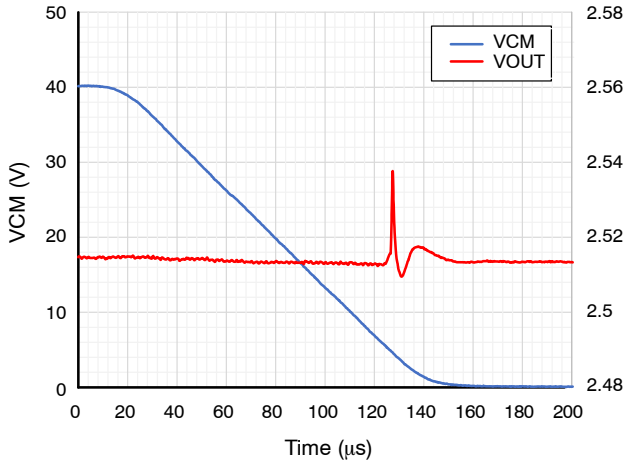

Figure 23d. Common Mode Voltage Step Falling, G100 (100µs)

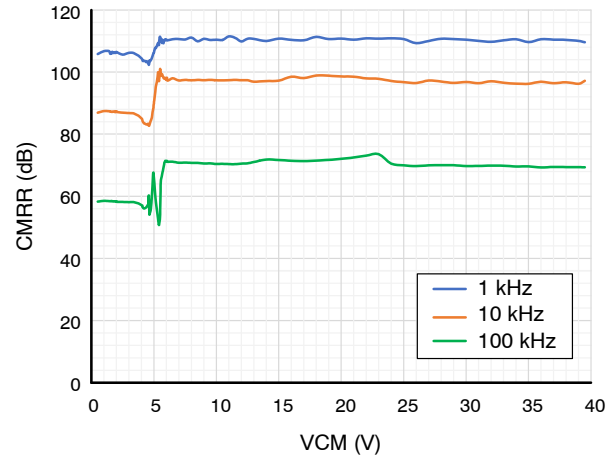

Figure 24a. Common Mode Rejection Ratio vs Common mode Voltage, G25

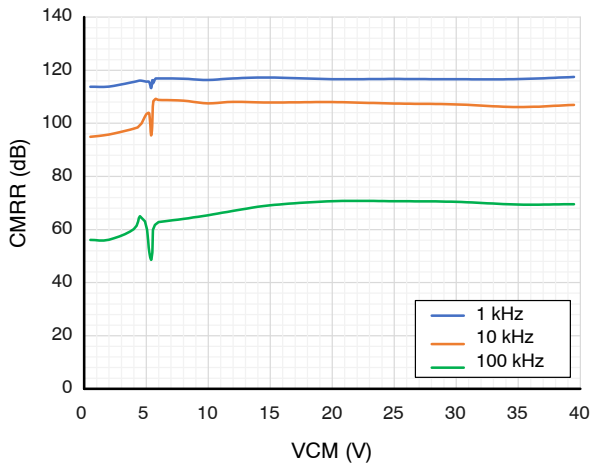

Figure 24b. Common Mode Rejection Ratio vs Common mode Voltage, G50

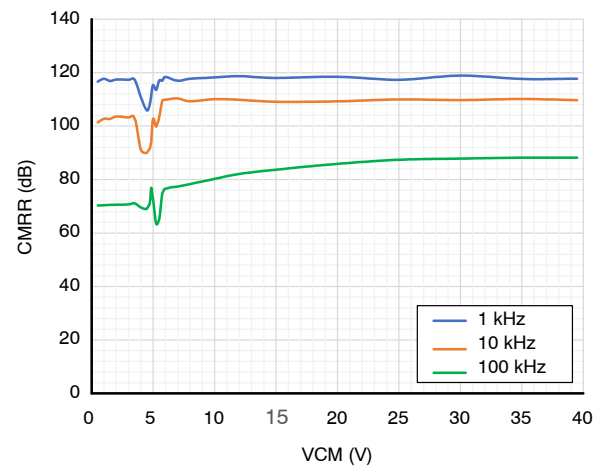

Figure 24c. Common Mode Rejection Ratio vs Common mode Voltage, G100

NCS21671, NCV21671

TYPICAL CHARACTERISTICS (At $T_A = +25^\circ\text{C}$, $V_{\text{SENSE}} = (V_{\text{IN}+}) - (V_{\text{IN}-})$; $V_S = V_{\text{EN}} = 1.8\text{ V}$, $V_{\text{REF}} = V_S/2$, $V_{\text{CM}} = 12\text{ V}$, and all gains unless otherwise noted.)
(continued)

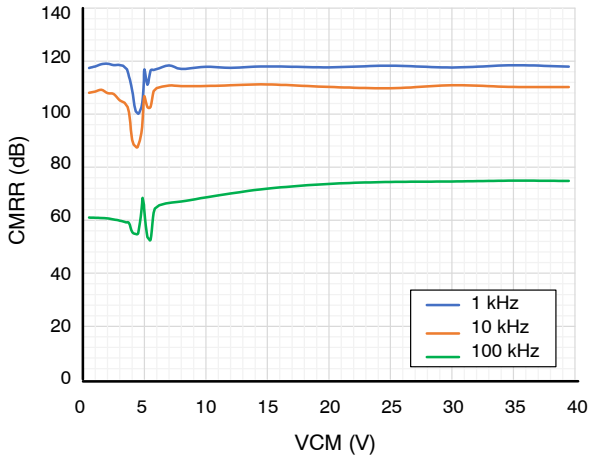

Figure 24d. Common Mode Rejection Ratio vs Common mode Voltage, G200

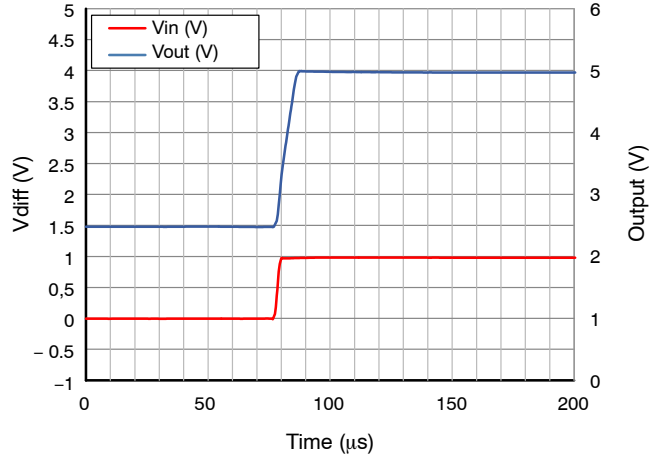

Figure 25a. Positive Differential Input Overload, G100

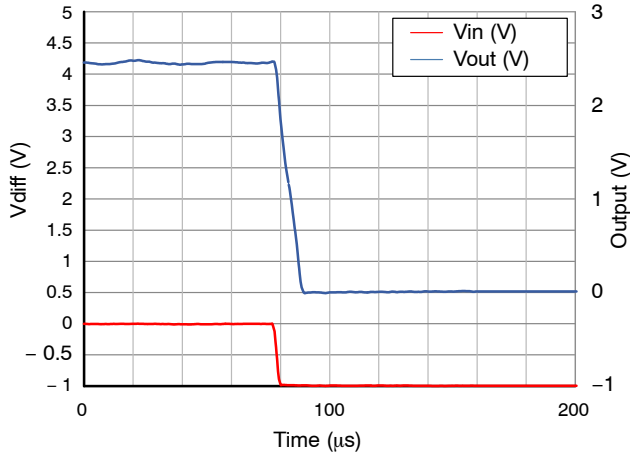

Figure 25b. Negative Differential Input Overload, G100

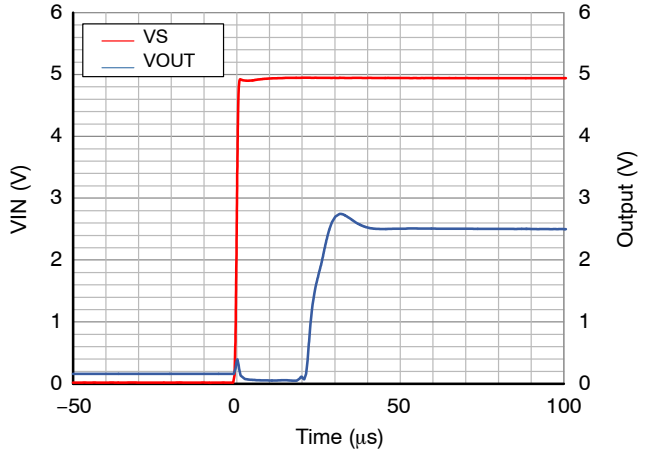

Figure 26a. VS Power Startup

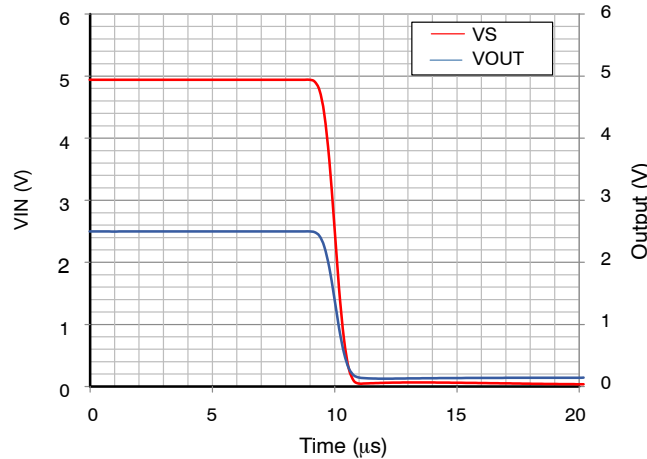

Figure 26b. VS Power Shutdown

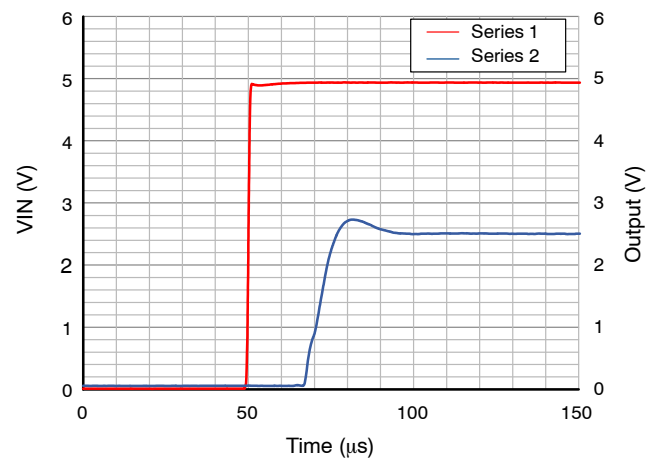

Figure 27a. Enable Startup

NCS21671, NCV21671

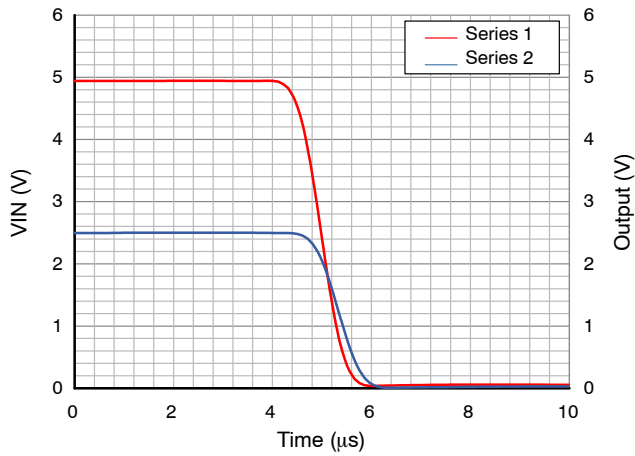

Figure 27b. Enable Shutdown

APPLICATION INFORMATION

Current Sensing Techniques

The NCS21671 and NCV21671 are current sense amplifiers featuring a wide common mode voltage range that spans from -0.1 V to 40 V independent of the supply voltage. These amplifiers can be configured for low-side and high-side current sensing.

At first glance, low-side sensing appears to have the advantage of being straightforward, inexpensive, and the ability to be implemented with a simple op amp circuit. However, the NCS21671 provides the full differential input necessary to get accurate shunt connections while also providing a built-in gain network with precision difficult to obtain with external resistors.

While at times the application requires low-side sensing, only high-side sensing can detect a short from the positive supply line to ground. Furthermore, high-side sensing avoids adding resistance to the ground path of the load being measured.

Bidirectional Operation

The NCS21671 can be configured to monitor unidirectional or bidirectional current flow.

In unidirectional current sensing, the measured load current always flows in the same direction. Common applications for unidirectional operation include power supplies and load current monitoring. The NCS21671 can be set up for unidirectional monitoring by connecting the REF pin to ground. In this configuration, the IN+ pin should be connected to the high side of the sense resistor, while the IN- pin should be connected to the low side of the sense resistor.

Bidirectional current sensing measures current flow in both directions. A common application for bidirectional current sensing is battery monitoring. While the battery is charging, current flows in one direction; while the battery is being used, current flows in the other direction. For bidirectional current flow, the REF pin can be connected to a voltage between GND and the Vs supply. Typically, the REF

pin is connected to the mid-supply voltage for bidirectional monitoring.

Enable Pin

The enable pin can be used to shut down the part and reduce current consumption. When the part is shut down, quiescent current drops to less than $1\text{ }\mu\text{A}$ and the inputs become high impedance. The output also becomes high impedance in the shutdown mode.

Input Filtering

Some applications may require filtering at the input of the current sense amplifier. Input filtering is simplified with the CIN+ and CIN- pins. Simply add an external capacitor across the pins to set the cutoff frequency, f_c .

$$f_c = \frac{1}{2\pi(2R_{\text{filt}})C_{\text{filt}}} \quad (\text{eq. 1})$$

Table 1. Internal Resistance Values

Gain (V/V)	R_{filt} (k Ω)	R_{in} (k Ω)	R_{fb} (M Ω)
25	20	20	1
50	10	10	1
100	5	5	1
200	2.5	2.5	1

The internal filter resistance has a tolerance of $\pm 25\%$.

If the filtering capacitor is not used, Cin+ and Cin- pins should be left floating.

As shunt resistors decrease in value, shunt inductance can significantly affect frequency response. At values below $1\text{ m}\Omega$, the shunt inductance causes a zero in the transfer function that often results in corner frequencies in the low 100's of kHz. This inductance increases the amplitude of high frequency spike transient events on the current sensing

NCS21671, NCV21671

line that can overload the front end of any shunt current sensing IC.

This problem must be solved by filtering at the input of the amplifier. Note that all current sensing ICs are vulnerable to this problem, regardless of manufacturer claims. Filtering is required at the input of the device to resolve this problem, even if the spike frequencies are above the rated bandwidth of the device.

Ideally, select the capacitor to exactly match the time constant of the shunt resistor and its inductance; alternatively, select the capacitor to provide a pole below that point. Make the input filter time constant equal to or larger than the shunt and its inductance time constant:

$$\frac{L_{SHUNT}}{R_{SHUNT}} \leq R_{FILT} C_{FILT} \quad (\text{eq. 2})$$

Selecting the Shunt Resistor

The desired accuracy of the current measurement determines the precision, shunt size, and the resistor value. The larger the resistor value, the more accurate the measurement possible, but a large resistor value also results in greater current loss.

For the most accurate measurements, use four terminal current sense resistors. It provides two terminals for the current path in the application circuit, and a second pair for the voltage detection path of the sense amplifier. This technique is also known as *Kelvin Sensing*. This ensures that the voltage measured by the sense amplifier is the actual voltage across the resistor and does not include the small resistance of a combined connection. When using non-Kelvin shunts, follow manufacturer recommendations on how to lay out the sensing traces closely.

Gain Options

The gain is set by integrated, precision, ratio-matched resistors. The NCS21671 is available in gain options of 25 V/V, 50 V/V, 100 V/V, and 200 V/V. Adding external resistors to adjust the gain can contribute to the overall system error and is not recommended.

$$P_D \approx V_{in}(I_{GND}@I_{out}) + I_{out}(V_{in} - V_{out}) \quad (\text{eq. 3})$$

$$V_{in(MAX)} \approx \frac{P_{D(MAX)} + (V_{out} \cdot I_{out})}{I_{out} + I_{GND}} \quad (\text{eq. 4})$$

ORDERING INFORMATION

Device	Channels	Package	Gain	OPN	Marking	Shipping†
--------	----------	---------	------	-----	---------	-----------

INDUSTRIAL AND CONSUMER

Package	GAIN	Enable	Filter Pins	Part Number	Marking	Shipping
SC70-6	25	No	No	NCS21671SQ025T2G	AAC(M)	Tape and Reel 3000 / Reel
	50			NCS21671SQ050T2G	\A/(YW)	
	100			NCS21671SQ100T2G	\A/(YW)	
	200			NCS21671SQ200T2G	R(YW)	
Micro10	25	Yes	Yes	NCS21671DM025R2G	G025	Tape and Reel 4000 / Reel
	50			NCS21671DM050R2G	G050	
	100			NCS21671DM100R2G	G100	
	200			NCS21671DM200R2G	G200	

AUTOMOTIVE GRADE1 QUALIFIED

Package	GAIN	Enable	Filter Pins	Part Number	Marking	Shipping
SC70-6	25	No	No	NCV21671SQ025T2G	AAC(M)	Tape and Reel 3000 / Reel
	50			NCV21671SQ050T2G	\A/(YW)	
	100			NCV21671SQ100T2G	\A/(YW)	
	200			NCV21671SQ200T2G	R(YW)	
Micro10	25	Yes	Yes	NCV21671DM025R2G	G025	Tape and Reel 4000 / Reel
	50			NCV21671DM050R2G	G050	
	100			NCV21671DM100R2G	G100	
	200			NCV21671DM200R2G	G200	

†For information on tape and reel specifications, including part orientation and tape sizes, please refer to our Tape and Reel Packaging Specifications Brochure, [BRD8011/D](#).

*NCV Prefix for Automotive and Other Applications Requiring Unique Site and Control Change Requirements; AEC-Q100 Qualified and PPAP Capable.

NCS21671, NCV21671

PACKAGE DIMENSIONS

SC-88/SC70-6/SOT-363
CASE 419B-02
ISSUE Y

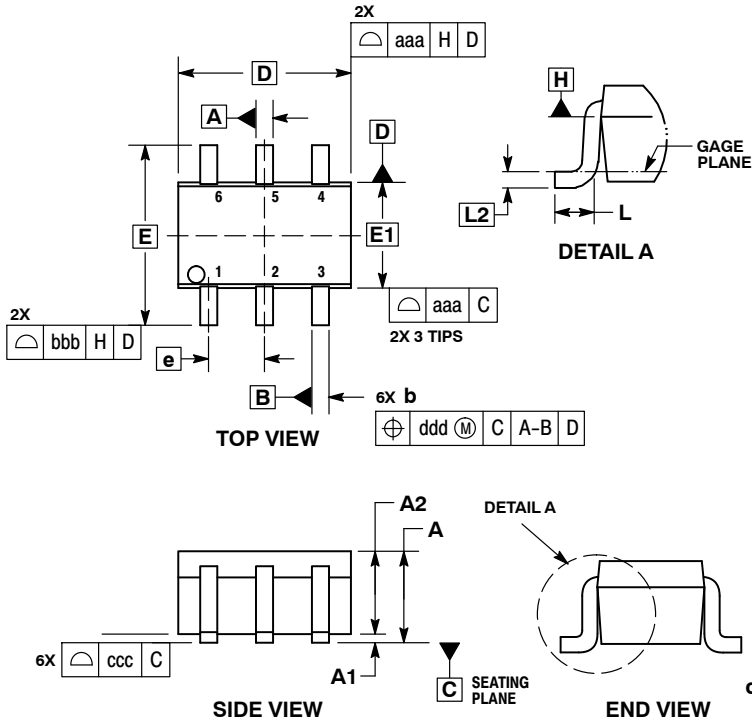

- NOTES:
1. DIMENSIONING AND TOLERANCING PER ASME Y14.5M, 1994.
 2. CONTROLLING DIMENSION: MILLIMETERS.
 3. DIMENSIONS D AND E1 DO NOT INCLUDE MOLD FLASH, PROTRUSIONS, OR GATE BURRS. MOLD FLASH, PROTRUSIONS, OR GATE BURRS SHALL NOT EXCEED 0.20 PER END.
 4. DIMENSIONS D AND E1 AT THE OUTERMOST EXTREMES OF THE PLASTIC BODY AND DATUM H.
 5. DATUMS A AND B ARE DETERMINED AT DATUM H.
 6. DIMENSIONS b AND c APPLY TO THE FLAT SECTION OF THE LEAD BETWEEN 0.08 AND 0.15 FROM THE TIP.
 7. DIMENSION b DOES NOT INCLUDE DAMBAR PROTRUSION. ALLOWABLE DAMBAR PROTRUSION SHALL BE 0.08 TOTAL IN EXCESS OF DIMENSION b AT MAXIMUM MATERIAL CONDITION. THE DAMBAR CANNOT BE LOCATED ON THE LOWER RADIUS OF THE FOOT.

DIM	MILLIMETERS			INCHES		
	MIN	NOM	MAX	MIN	NOM	MAX
A	---	---	1.10	---	---	0.043
A1	0.00	---	0.10	0.000	---	0.004
A2	0.70	0.90	1.00	0.027	0.035	0.039
b	0.15	0.20	0.25	0.006	0.008	0.010
C	0.08	0.15	0.22	0.003	0.006	0.009
D	1.80	2.00	2.20	0.070	0.078	0.086
E	2.00	2.10	2.20	0.078	0.082	0.086
E1	1.15	1.25	1.35	0.045	0.049	0.053
e	0.65 BSC			0.026 BSC		
L	0.26	0.36	0.46	0.010	0.014	0.018
L2	0.15 BSC			0.006 BSC		
aaa	0.15			0.006		
bbb	0.30			0.012		
ccc	0.10			0.004		
ddd	0.10			0.004		

RECOMMENDED SOLDERING FOOTPRINT*

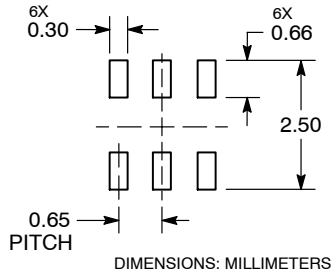

*For additional information on our Pb-Free strategy and soldering details, please download the **onsemi** Soldering and Mounting Techniques Reference Manual, SOLDERRM/D.

STYLES ON PAGE 2

NCS21671, NCV21671

SC-88/SC70-6/SOT-363

CASE 419B-02

ISSUE Y

STYLE 1: PIN 1. EMITTER 2 2. BASE 2 3. COLLECTOR 1 4. EMITTER 1 5. BASE 1 6. COLLECTOR 2	STYLE 2: CANCELLED	STYLE 3: CANCELLED	STYLE 4: PIN 1. CATHODE 2. CATHODE 3. COLLECTOR 4. EMITTER 5. BASE 6. ANODE	STYLE 5: PIN 1. ANODE 2. ANODE 3. COLLECTOR 4. EMITTER 5. BASE 6. CATHODE	STYLE 6: PIN 1. ANODE 2 2. N/C 3. CATHODE 1 4. ANODE 1 5. N/C 6. CATHODE 2
STYLE 7: PIN 1. SOURCE 2 2. DRAIN 2 3. GATE 1 4. SOURCE 1 5. DRAIN 1 6. GATE 2	STYLE 8: CANCELLED	STYLE 9: PIN 1. EMITTER 2 2. EMITTER 1 3. COLLECTOR 1 4. BASE 1 5. BASE 2 6. COLLECTOR 2	STYLE 10: PIN 1. SOURCE 2 2. SOURCE 1 3. GATE 1 4. DRAIN 1 5. DRAIN 2 6. GATE 2	STYLE 11: PIN 1. CATHODE 2 2. CATHODE 2 3. ANODE 1 4. CATHODE 1 5. CATHODE 1 6. ANODE 2	STYLE 12: PIN 1. ANODE 2 2. ANODE 2 3. CATHODE 1 4. ANODE 1 5. ANODE 1 6. CATHODE 2
STYLE 13: PIN 1. ANODE 2. N/C 3. COLLECTOR 4. EMITTER 5. BASE 6. CATHODE	STYLE 14: PIN 1. VREF 2. GND 3. GND 4. IOUT 5. VEN 6. VCC	STYLE 15: PIN 1. ANODE 1 2. ANODE 2 3. ANODE 3 4. CATHODE 3 5. CATHODE 2 6. CATHODE 1	STYLE 16: PIN 1. BASE 1 2. EMITTER 2 3. COLLECTOR 2 4. BASE 2 5. EMITTER 1 6. COLLECTOR 1	STYLE 17: PIN 1. BASE 1 2. EMITTER 1 3. COLLECTOR 2 4. BASE 2 5. EMITTER 2 6. COLLECTOR 1	STYLE 18: PIN 1. VIN1 2. VCC 3. VOUT2 4. VIN2 5. GND 6. VOUT1
STYLE 19: PIN 1. IOUT 2. GND 3. GND 4. V CC 5. V EN 6. V REF	STYLE 20: PIN 1. COLLECTOR 2. COLLECTOR 3. BASE 4. EMITTER 5. COLLECTOR 6. COLLECTOR	STYLE 21: PIN 1. ANODE 1 2. N/C 3. ANODE 2 4. CATHODE 2 5. N/C 6. CATHODE 1	STYLE 22: PIN 1. D1 (i) 2. GND 3. D2 (i) 4. D2 (c) 5. VBUS 6. D1 (c)	STYLE 23: PIN 1. Vn 2. CH1 3. Vp 4. N/C 5. CH2 6. N/C	STYLE 24: PIN 1. CATHODE 2. ANODE 3. CATHODE 4. CATHODE 5. CATHODE 6. CATHODE
STYLE 25: PIN 1. BASE 1 2. CATHODE 3. COLLECTOR 2 4. BASE 2 5. EMITTER 6. COLLECTOR 1	STYLE 26: PIN 1. SOURCE 1 2. GATE 1 3. DRAIN 2 4. SOURCE 2 5. GATE 2 6. DRAIN 1	STYLE 27: PIN 1. BASE 2 2. BASE 1 3. COLLECTOR 1 4. EMITTER 1 5. EMITTER 2 6. COLLECTOR 2	STYLE 28: PIN 1. DRAIN 2. DRAIN 3. GATE 4. SOURCE 5. DRAIN 6. DRAIN	STYLE 29: PIN 1. ANODE 2. ANODE 3. COLLECTOR 4. EMITTER 5. BASE/ANODE 6. CATHODE	STYLE 30: PIN 1. SOURCE 1 2. DRAIN 2 3. DRAIN 2 4. SOURCE 2 5. GATE 1 6. DRAIN 1

Note: Please refer to datasheet for style callout. If style type is not called out in the datasheet refer to the device datasheet pinout or pin assignment.

NCS21671, NCV21671

Micro10 CASE 846B-03 ISSUE D

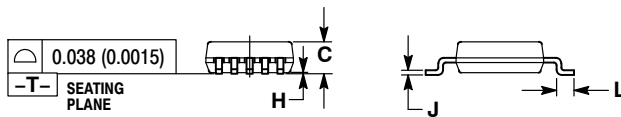
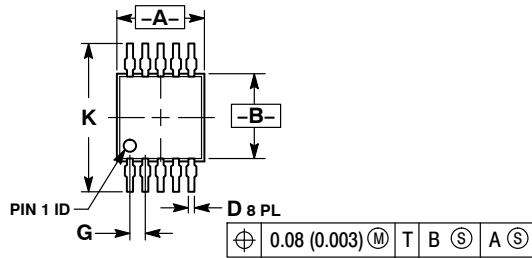

NOTES:

1. DIMENSIONING AND TOLERANCING PER ANSI Y14.5M, 1982.
2. CONTROLLING DIMENSION: MILLIMETER.
3. DIMENSION "A" DOES NOT INCLUDE MOLD FLASH, PROTRUSIONS OR GATE BURRS. MOLD FLASH, PROTRUSIONS OR GATE BURRS SHALL NOT EXCEED 0.15 (0.006) PER SIDE.
4. DIMENSION "B" DOES NOT INCLUDE INTERLEAD FLASH OR PROTRUSION. INTERLEAD FLASH OR PROTRUSION SHALL NOT EXCEED 0.25 (0.010) PER SIDE.
5. 846B-01 OBSOLETE. NEW STANDARD 846B-02

DIM	MILLIMETERS		INCHES	
	MIN	MAX	MIN	MAX
A	2.90	3.10	0.114	0.122
B	2.90	3.10	0.114	0.122
C	0.95	1.10	0.037	0.043
D	0.20	0.30	0.008	0.012
G	0.50 BSC		0.020 BSC	
H	0.05	0.15	0.002	0.006
J	0.10	0.21	0.004	0.008
K	4.75	5.05	0.187	0.199
L	0.40	0.70	0.016	0.028

SOLDERING FOOTPRINT

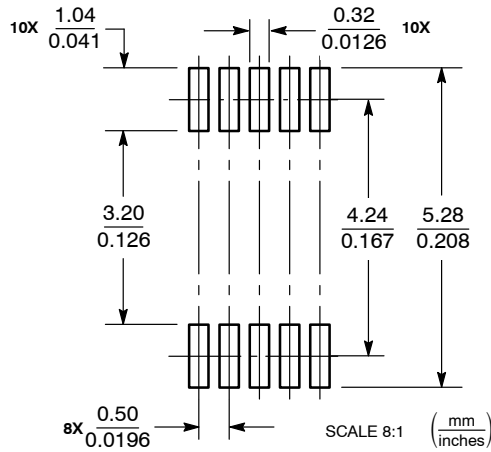

Micro10

onsemi, Onsemi, and other names, marks, and brands are registered and/or common law trademarks of Semiconductor Components Industries, LLC dba "onsemi" or its affiliates and/or subsidiaries in the United States and/or other countries. onsemi owns the rights to a number of patents, trademarks, copyrights, trade secrets, and other intellectual property. A listing of onsemi's product/patent coverage may be accessed at www.onsemi.com/site/pdf/Patent-Marking.pdf. onsemi reserves the right to make changes at any time to any products or information herein, without notice. The information herein is provided "as-is" and onsemi makes no warranty, representation or guarantee regarding the accuracy of the information, product features, availability, functionality, or suitability of its products for any particular purpose, nor does onsemi assume any liability arising out of the application or use of any product or circuit, and specifically disclaims any and all liability, including without limitation special, consequential or incidental damages. Buyer is responsible for its products and applications using onsemi products, including compliance with all laws, regulations and safety requirements or standards, regardless of any support or applications information provided by onsemi. "Typical" parameters which may be provided in onsemi data sheets and/or specifications can and do vary in different applications and actual performance may vary over time. All operating parameters, including "Typicals" must be validated for each customer application by customer's technical experts. onsemi does not convey any license under any of its intellectual property rights nor the rights of others. onsemi products are not designed, intended, or authorized for use as a critical component in life support systems or any FDA Class 3 medical devices or medical devices with a same or similar classification in a foreign jurisdiction or any devices intended for implantation in the human body. Should Buyer purchase or use onsemi products for any such unintended or unauthorized application, Buyer shall indemnify and hold onsemi and its officers, employees, subsidiaries, affiliates, and distributors harmless against all claims, costs, damages, and expenses, and reasonable attorney fees arising out of, directly or indirectly, any claim of personal injury or death associated with such unintended or unauthorized use, even if such claim alleges that onsemi was negligent regarding the design or manufacture of the part. onsemi is an Equal Opportunity/Affirmative Action Employer. This literature is subject to all applicable copyright laws and is not for resale in any manner.

PUBLICATION ORDERING INFORMATION

LITERATURE FULFILLMENT:
Email Requests to: orderlit@onsemi.com

onsemi Website: www.onsemi.com

TECHNICAL SUPPORT
North American Technical Support:
Voice Mail: 1 800-282-9855 Toll Free USA/Canada
Phone: 011 421 33 790 2910

Europe, Middle East and Africa Technical Support:
Phone: 00421 33 790 2910
For additional information, please contact your local Sales Representative



SC-88 2.00x1.25x0.90, 0.65P
CASE 419B-02
ISSUE Z

DATE 18 APR 2024

NOTES:

1. DIMENSIONING AND TOLERANCING CONFORM TO ASME Y14.5-2018.
2. ALL DIMENSION ARE IN MILLIMETERS.
3. DIMENSIONS D AND E1 DO NOT INCLUDE MOLD FLASH, PROTRUSIONS, OR GATE BURRS. MOLD FLASH, PROTRUSIONS, OR GATE BURRS SHALL NOT EXCEED 0.20 PER END.
4. DIMENSIONS D AND E1 AT THE OUTERMOST EXTREMES OF THE PLASTIC BODY AND DATUM H.
5. DATUMS A AND B ARE DETERMINED AT DATUM H.
6. DIMENSIONS b AND c APPLY TO THE FLAT SECTION OF THE LEAD BETWEEN 0.08 AND 0.15 FROM THE TIP.
7. DIMENSION b DOES NOT INCLUDE DAMBAR PROTRUSION. ALLOWABLE DAMBAR PROTRUSION SHALL BE 0.08 TOTAL IN EXCESS OF DIMENSION b AT MAXIMUM MATERIAL CONDITION. THE DAMBAR CANNOT BE LOCATED ON THE LOWER RADIUS OF THE FOOT.

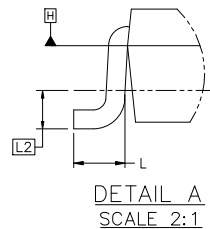
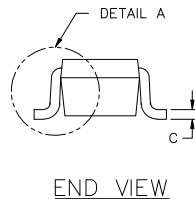
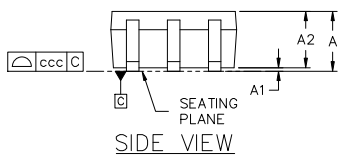
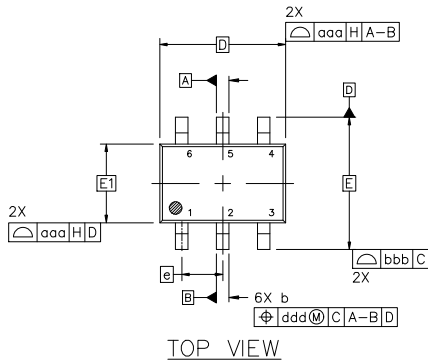

DIM	MILLIMETERS		
	MIN.	NOM.	MAX.
A	---	---	1.10
A1	0.00	---	0.10
A2	0.70	0.90	1.00
b	0.15	0.20	0.25
c	0.08	0.15	0.22
D	2.00 BSC		
E	2.10 BSC		
E1	1.25 BSC		
e	0.65 BSC		
L	0.26	0.36	0.46
L2	0.15 BSC		
aaa	0.15		
bbb	0.30		
ccc	0.10		
ddd	0.10		

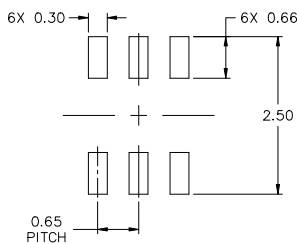

* FOR ADDITIONAL INFORMATION ON OUR Pb-FREE STRATEGY AND SOLDERING DETAILS, PLEASE DOWNLOAD THE ONSEMI SOLDERING AND MOUNTING TECHNIQUES REFERENCE MANUAL, SOLDERRM/D.

GENERIC MARKING DIAGRAM*

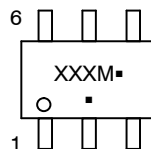

XXX = Specific Device Code
M = Date Code*
▪ = Pb-Free Package

(Note: Microdot may be in either location)

*Date Code orientation and/or position may vary depending upon manufacturing location.

*This information is generic. Please refer to device data sheet for actual part marking. Pb-Free indicator, "G" or microdot "▪", may or may not be present. Some products may not follow the Generic Marking.

STYLES ON PAGE 2

DOCUMENT NUMBER:	98ASB42985B	Electronic versions are uncontrolled except when accessed directly from the Document Repository. Printed versions are uncontrolled except when stamped "CONTROLLED COPY" in red.
DESCRIPTION:	SC-88 2.00x1.25x0.90, 0.65P	PAGE 1 OF 2

onsemi and ONSEMI are trademarks of Semiconductor Components Industries, LLC dba onsemi or its subsidiaries in the United States and/or other countries. onsemi reserves the right to make changes without further notice to any products herein. onsemi makes no warranty, representation or guarantee regarding the suitability of its products for any particular purpose, nor does onsemi assume any liability arising out of the application or use of any product or circuit, and specifically disclaims any and all liability, including without limitation special, consequential or incidental damages. onsemi does not convey any license under its patent rights nor the rights of others.

SC-88 2.00x1.25x0.90, 0.65P
CASE 419B-02
ISSUE Z

DATE 18 APR 2024

STYLE 1: PIN 1. EMITTER 2 2. BASE 2 3. COLLECTOR 1 4. EMITTER 1 5. BASE 1 6. COLLECTOR 2	STYLE 2: CANCELLED	STYLE 3: CANCELLED	STYLE 4: PIN 1. CATHODE 2. CATHODE 3. COLLECTOR 4. EMITTER 5. BASE 6. ANODE	STYLE 5: PIN 1. ANODE 2. ANODE 3. COLLECTOR 4. EMITTER 5. BASE 6. CATHODE	STYLE 6: PIN 1. ANODE 2 2. N/C 3. CATHODE 1 4. ANODE 1 5. N/C 6. CATHODE 2
STYLE 7: PIN 1. SOURCE 2 2. DRAIN 2 3. GATE 1 4. SOURCE 1 5. DRAIN 1 6. GATE 2	STYLE 8: CANCELLED	STYLE 9: PIN 1. EMITTER 2 2. EMITTER 1 3. COLLECTOR 1 4. BASE 1 5. BASE 2 6. COLLECTOR 2	STYLE 10: PIN 1. SOURCE 2 2. SOURCE 1 3. GATE 1 4. DRAIN 1 5. DRAIN 2 6. GATE 2	STYLE 11: PIN 1. CATHODE 2 2. CATHODE 2 3. ANODE 1 4. CATHODE 1 5. CATHODE 1 6. ANODE 2	STYLE 12: PIN 1. ANODE 2 2. ANODE 2 3. CATHODE 1 4. ANODE 1 5. ANODE 1 6. CATHODE 2
STYLE 13: PIN 1. ANODE 2. N/C 3. COLLECTOR 4. EMITTER 5. BASE 6. CATHODE	STYLE 14: PIN 1. VREF 2. GND 3. GND 4. IOUT 5. VEN 6. VCC	STYLE 15: PIN 1. ANODE 1 2. ANODE 2 3. ANODE 3 4. CATHODE 3 5. CATHODE 2 6. CATHODE 1	STYLE 16: PIN 1. BASE 1 2. EMITTER 2 3. COLLECTOR 2 4. BASE 2 5. EMITTER 1 6. COLLECTOR 1	STYLE 17: PIN 1. BASE 1 2. EMITTER 1 3. COLLECTOR 2 4. BASE 2 5. EMITTER 2 6. COLLECTOR 1	STYLE 18: PIN 1. VIN1 2. VCC 3. VOUT2 4. VIN2 5. GND 6. VOUT1
STYLE 19: PIN 1. IOUT 2. GND 3. GND 4. V CC 5. V EN 6. V REF	STYLE 20: PIN 1. COLLECTOR 2. COLLECTOR 3. BASE 4. EMITTER 5. COLLECTOR 6. COLLECTOR	STYLE 21: PIN 1. ANODE 1 2. N/C 3. ANODE 2 4. CATHODE 2 5. N/C 6. CATHODE 1	STYLE 22: PIN 1. D1 (i) 2. GND 3. D2 (j) 4. D2 (c) 5. VBUS 6. D1 (c)	STYLE 23: PIN 1. Vn 2. CH1 3. Vp 4. N/C 5. CH2 6. N/C	STYLE 24: PIN 1. CATHODE 2. ANODE 3. CATHODE 4. CATHODE 5. CATHODE 6. CATHODE
STYLE 25: PIN 1. BASE 1 2. CATHODE 3. COLLECTOR 2 4. BASE 2 5. EMITTER 6. COLLECTOR 1	STYLE 26: PIN 1. SOURCE 1 2. GATE 1 3. DRAIN 2 4. SOURCE 2 5. GATE 2 6. DRAIN 1	STYLE 27: PIN 1. BASE 2 2. BASE 1 3. COLLECTOR 1 4. EMITTER 1 5. EMITTER 2 6. COLLECTOR 2	STYLE 28: PIN 1. DRAIN 2. DRAIN 3. GATE 4. SOURCE 5. DRAIN 6. DRAIN	STYLE 29: PIN 1. ANODE 2. ANODE 3. COLLECTOR 4. EMITTER 5. BASE/ANODE 6. CATHODE	STYLE 30: PIN 1. SOURCE 1 2. DRAIN 2 3. DRAIN 2 4. SOURCE 2 5. GATE 1 6. DRAIN 1

Note: Please refer to datasheet for style callout. If style type is not called out in the datasheet refer to the device datasheet pinout or pin assignment.

DOCUMENT NUMBER:	98ASB42985B	Electronic versions are uncontrolled except when accessed directly from the Document Repository. Printed versions are uncontrolled except when stamped "CONTROLLED COPY" in red.
DESCRIPTION:	SC-88 2.00x1.25x0.90, 0.65P	PAGE 2 OF 2

onsemi and **ONSEMI** are trademarks of Semiconductor Components Industries, LLC dba **onsemi** or its subsidiaries in the United States and/or other countries. **onsemi** reserves the right to make changes without further notice to any products herein. **onsemi** makes no warranty, representation or guarantee regarding the suitability of its products for any particular purpose, nor does **onsemi** assume any liability arising out of the application or use of any product or circuit, and specifically disclaims any and all liability, including without limitation special, consequential or incidental damages. **onsemi** does not convey any license under its patent rights nor the rights of others.

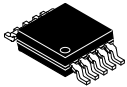

SCALE 2:1

Micro10
CASE 846B
ISSUE D

DATE 07 DEC 2004

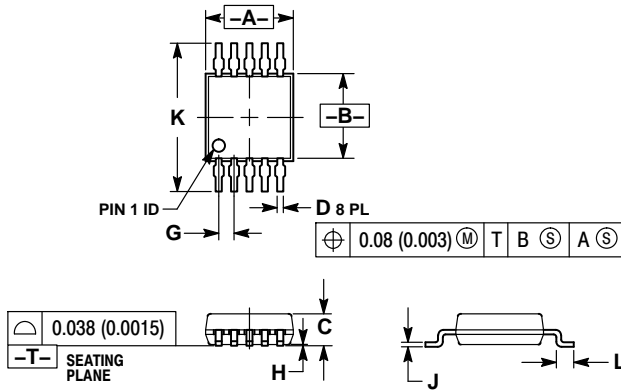

SOLDERING FOOTPRINT

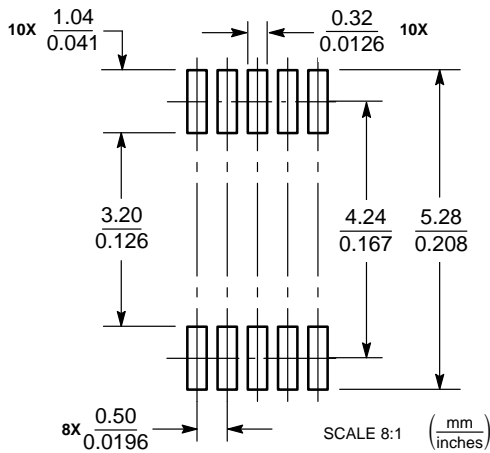

Micro10

NOTES:

1. DIMENSIONING AND TOLERANCING PER ANSI Y14.5M, 1982.
2. CONTROLLING DIMENSION: MILLIMETER.
3. DIMENSION "A" DOES NOT INCLUDE MOLD FLASH, PROTRUSIONS OR GATE BURRS. MOLD FLASH, PROTRUSIONS OR GATE BURRS SHALL NOT EXCEED 0.15 (0.006) PER SIDE.
4. DIMENSION "B" DOES NOT INCLUDE INTERLEAD FLASH OR PROTRUSION. INTERLEAD FLASH OR PROTRUSION SHALL NOT EXCEED 0.25 (0.010) PER SIDE.
5. 846B-01 OBSOLETE. NEW STANDARD 846B-02

MILLIMETERS		INCHES		
DIM	MIN	MAX	MIN	MAX
A	2.90	3.10	0.114	0.122
B	2.90	3.10	0.114	0.122
C	0.95	1.10	0.037	0.043
D	0.20	0.30	0.008	0.012
G	0.50 BSC		0.020 BSC	
H	0.05	0.15	0.002	0.006
J	0.10	0.21	0.004	0.008
K	4.75	5.05	0.187	0.199
L	0.40	0.70	0.016	0.028

GENERIC MARKING DIAGRAM*

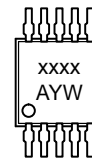

- xxxx = Device Code
- A = Assembly Location
- Y = Year
- W = Work Week
- = Pb-Free Package

*This information is generic. Please refer to device data sheet for actual part marking. Pb-Free indicator, "G" or microdot "▪", may or may not be present. Some products may not follow the Generic Marking.

DOCUMENT NUMBER:	98AON03799D	Electronic versions are uncontrolled except when accessed directly from the Document Repository. Printed versions are uncontrolled except when stamped "CONTROLLED COPY" in red.
DESCRIPTION:	Micro10	PAGE 1 OF 1

onsemi and ONSEMI are trademarks of Semiconductor Components Industries, LLC dba onsemi or its subsidiaries in the United States and/or other countries. onsemi reserves the right to make changes without further notice to any products herein. onsemi makes no warranty, representation or guarantee regarding the suitability of its products for any particular purpose, nor does onsemi assume any liability arising out of the application or use of any product or circuit, and specifically disclaims any and all liability, including without limitation special, consequential or incidental damages. onsemi does not convey any license under its patent rights nor the rights of others.

onsemi, **Onsemi**, and other names, marks, and brands are registered and/or common law trademarks of Semiconductor Components Industries, LLC dba "**onsemi**" or its affiliates and/or subsidiaries in the United States and/or other countries. **onsemi** owns the rights to a number of patents, trademarks, copyrights, trade secrets, and other intellectual property. A listing of **onsemi**'s product/patent coverage may be accessed at www.onsemi.com/site/pdf/Patent-Marking.pdf. **onsemi** reserves the right to make changes at any time to any products or information herein, without notice. The information herein is provided "as-is" and **onsemi** makes no warranty, representation or guarantee regarding the accuracy of the information, product features, availability, functionality, or suitability of its products for any particular purpose, nor does **onsemi** assume any liability arising out of the application or use of any product or circuit, and specifically disclaims any and all liability, including without limitation special, consequential or incidental damages. Buyer is responsible for its products and applications using **onsemi** products, including compliance with all laws, regulations and safety requirements or standards, regardless of any support or applications information provided by **onsemi**. "Typical" parameters which may be provided in **onsemi** data sheets and/or specifications can and do vary in different applications and actual performance may vary over time. All operating parameters, including "Typicals" must be validated for each customer application by customer's technical experts. **onsemi** does not convey any license under any of its intellectual property rights nor the rights of others. **onsemi** products are not designed, intended, or authorized for use as a critical component in life support systems or any FDA Class 3 medical devices or medical devices with a same or similar classification in a foreign jurisdiction or any devices intended for implantation in the human body. Should Buyer purchase or use **onsemi** products for any such unintended or unauthorized application, Buyer shall indemnify and hold **onsemi** and its officers, employees, subsidiaries, affiliates, and distributors harmless against all claims, costs, damages, and expenses, and reasonable attorney fees arising out of, directly or indirectly, any claim of personal injury or death associated with such unintended or unauthorized use, even if such claim alleges that **onsemi** was negligent regarding the design or manufacture of the part. **onsemi** is an Equal Opportunity/Affirmative Action Employer. This literature is subject to all applicable copyright laws and is not for resale in any manner.

ADDITIONAL INFORMATION

TECHNICAL PUBLICATIONS:

Technical Library: www.onsemi.com/design/resources/technical-documentation
onsemi Website: www.onsemi.com

ONLINE SUPPORT: www.onsemi.com/support

For additional information, please contact your local Sales Representative at www.onsemi.com/support/sales