

NGTB15N60S1EG

IGBT - Short-Circuit Rated

This Insulated Gate Bipolar Transistor (IGBT) features a robust and cost effective Non-Punch Through (NPT) Trench construction, and provides superior performance in demanding switching applications. Offering both low on state voltage and minimal switching loss, the IGBT is well suited for motor drive control and other hard switching applications. Incorporated into the device is a rugged co-packaged reverse recovery diode with a low forward voltage.

Features

- Low Saturation Voltage Resulting in Low Conduction Loss
- Low Switching Loss in Higher Frequency Applications
- Soft Fast Reverse Recovery Diode
- 5 μ s Short Circuit Capability
- Excellent Current versus Package Size Performance Density
- This is a Pb-Free Device

Typical Applications

- White Goods Appliance Motor Control
- General Purpose Inverter
- AC and DC Motor Control

ABSOLUTE MAXIMUM RATINGS

Rating	Symbol	Value	Unit
Collector-emitter voltage	V_{CES}	650	V
Collector current @ $T_C = 25^\circ\text{C}$ @ $T_C = 100^\circ\text{C}$	I_C	30 15	A
Pulsed collector current, T_{pulse} limited by $T_{J\text{max}}$	I_{CM}	120	A
Diode forward current @ $T_C = 25^\circ\text{C}$ @ $T_C = 100^\circ\text{C}$	I_F	30 15	A
Diode pulsed current, T_{pulse} limited by $T_{J\text{max}}$	I_{FM}	120	A
Gate-emitter voltage	V_{GE}	± 20	V
Power dissipation @ $T_C = 25^\circ\text{C}$ @ $T_C = 100^\circ\text{C}$	P_D	117 47	W
Short circuit withstand time $V_{GE} = 15\text{ V}$, $V_{CE} = 400\text{ V}$, $T_J \leq +150^\circ\text{C}$	t_{SC}	5	μs
Operating junction temperature range	T_J	-55 to +150	$^\circ\text{C}$
Storage temperature range	T_{stg}	-55 to +150	$^\circ\text{C}$
Lead temperature for soldering, 1/8" from case for 5 seconds	T_{SLD}	260	$^\circ\text{C}$

Stresses exceeding those listed in the Maximum Ratings table may damage the device. If any of these limits are exceeded, device functionality should not be assumed, damage may occur and reliability may be affected.



ON Semiconductor®

www.onsemi.com

15 A, 650 V
 $V_{CE\text{sat}} = 1.5\text{ V}$

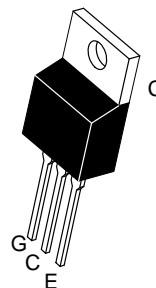
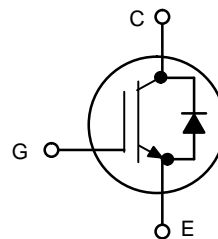

TO-220
CASE 221A
STYLE 9

MARKING DIAGRAM

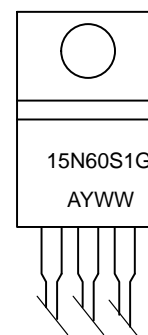

A = Assembly Location
Y = Year
WW = Work Week
G = Pb-Free Package

ORDERING INFORMATION

Device	Package	Shipping
NGTB15N60S1EG	TO-220 (Pb-Free)	50 Units / Rail

NGTB15N60S1EG

THERMAL CHARACTERISTICS

Rating	Symbol	Value	Unit
Thermal resistance junction to case, for IGBT	$R_{\theta JC}$	0.5	$^{\circ}\text{C}/\text{W}$
Thermal resistance junction to case, for Diode	$R_{\theta JC}$	2.3	$^{\circ}\text{C}/\text{W}$
Thermal resistance junction to ambient	$R_{\theta JA}$	60	$^{\circ}\text{C}/\text{W}$

ELECTRICAL CHARACTERISTICS ($T_J = 25^{\circ}\text{C}$ unless otherwise specified)

Parameter	Test Conditions	Symbol	Min	Typ	Max	Unit
-----------	-----------------	--------	-----	-----	-----	------

STATIC CHARACTERISTIC

Collector-emitter breakdown voltage, gate-emitter short-circuited	$V_{GE} = 0\text{ V}, I_C = 500\ \mu\text{A}$ $V_{GE} = 0\text{ V}, I_C = 500\ \mu\text{A}, T_J = -40^{\circ}\text{C}$	$V_{(BR)CES}$	650 -	720 660	- -	V
Collector-emitter saturation voltage	$V_{GE} = 15\text{ V}, I_C = 15\text{ A}$ $V_{GE} = 15\text{ V}, I_C = 15\text{ A}, T_J = 150^{\circ}\text{C}$	V_{CEsat}	1.3 1.55	1.5 1.75	1.7 1.95	V
Gate-emitter threshold voltage	$V_{GE} = V_{CE}, I_C = 250\ \mu\text{A}$	$V_{GE(th)}$	4.5	5.5	6.5	V
Collector-emitter cut-off current, gate-emitter short-circuited	$V_{GE} = 0\text{ V}, V_{CE} = 650\text{ V}$ $V_{GE} = 0\text{ V}, V_{CE} = 650\text{ V}, T_J = 150^{\circ}\text{C}$	I_{CES}	- -	10 -	- 200	μA
Gate leakage current, collector-emitter short-circuited	$V_{GE} = 20\text{ V}, V_{CE} = 0\text{ V}$	I_{GES}	-	-	100	nA
Forward Transconductance	$V_{CE} = 20\text{ V}, I_C = 15\text{ A}$	g_{fs}	-	10.1	-	S

DYNAMIC CHARACTERISTIC

Input capacitance	$V_{CE} = 20\text{ V}, V_{GE} = 0\text{ V}, f = 1\text{ MHz}$	C_{ies}	-	1950	-	pF
Output capacitance		C_{oes}	-	70	-	
Reverse transfer capacitance		C_{res}	-	42	-	
Gate charge total	$V_{CE} = 480\text{ V}, I_C = 15\text{ A}, V_{GE} = 15\text{ V}$	Q_g	-	88	-	nC
Gate to emitter charge		Q_{ge}	-	16	-	
Gate to collector charge		Q_{gc}	-	42	-	

SWITCHING CHARACTERISTIC , INDUCTIVE LOAD

Turn-on delay time	$T_J = 25^{\circ}\text{C}$ $V_{CC} = 400\text{ V}, I_C = 15\text{ A}$ $R_g = 22\ \Omega$ $V_{GE} = 0\text{ V} / 15\text{ V}$	$t_{d(on)}$	-	65	-	ns		
Rise time		t_r	-	28	-			
Turn-off delay time		$t_{d(off)}$	-	170	-			
Fall time		t_f	-	140	-			
Turn-on switching loss		$T_J = 150^{\circ}\text{C}$ $V_{CC} = 400\text{ V}, I_C = 15\text{ A}$ $R_g = 22\ \Omega$ $V_{GE} = 0\text{ V} / 15\text{ V}$	E_{on}	-	0.550	-	mJ	
Turn-off switching loss			E_{off}	-	0.350	-		
Total switching loss			E_{ts}	-	0.900	-		
Turn-on delay time			$T_J = 150^{\circ}\text{C}$ $V_{CC} = 400\text{ V}, I_C = 15\text{ A}$ $R_g = 22\ \Omega$ $V_{GE} = 0\text{ V} / 15\text{ V}$	$t_{d(on)}$	-	65	-	ns
Rise time				t_r	-	28	-	
Turn-off delay time				$t_{d(off)}$	-	180	-	
Fall time	t_f	-		260	-			
Turn-on switching loss	$T_J = 150^{\circ}\text{C}$ $V_{CC} = 400\text{ V}, I_C = 15\text{ A}$ $R_g = 22\ \Omega$ $V_{GE} = 0\text{ V} / 15\text{ V}$	E_{on}		-	0.650	-	mJ	
Turn-off switching loss		E_{off}		-	0.600	-		
Total switching loss		E_{ts}	-	1.250	-			

DIODE CHARACTERISTIC

Forward voltage	$V_{GE} = 0\text{ V}, I_F = 15\text{ A}$ $V_{GE} = 0\text{ V}, I_F = 15\text{ A}, T_J = 150^{\circ}\text{C}$	V_F	- -	1.65 1.75	1.85 -	V
-----------------	---	-------	--------	--------------	-----------	---

NGTB15N60S1EG

ELECTRICAL CHARACTERISTICS ($T_J = 25^\circ\text{C}$ unless otherwise specified)

Parameter	Test Conditions	Symbol	Min	Typ	Max	Unit
DIODE CHARACTERISTIC						
Reverse recovery time	$T_J = 25^\circ\text{C}$ $I_F = 15\text{ A}, V_R = 200\text{ V}$ $di_F/dt = 200\text{ A}/\mu\text{s}$	t_{rr}	-	270	-	ns
Reverse recovery charge		Q_{rr}	-	350	-	nc
Reverse recovery current		I_{rrm}	-	5	-	A
Reverse recovery time	$T_J = 125^\circ\text{C}$ $I_F = 15\text{ A}, V_R = 200\text{ V}$ $di_F/dt = 200\text{ A}/\mu\text{s}$	t_{rr}	-	350	-	ns
Reverse recovery charge		Q_{rr}	-	1000	-	nc
Reverse recovery current		I_{rrm}	-	7.5	-	A

Product parametric performance is indicated in the Electrical Characteristics for the listed test conditions, unless otherwise noted. Product performance may not be indicated by the Electrical Characteristics if operated under different conditions.

NGTB15N60S1EG

TYPICAL CHARACTERISTICS

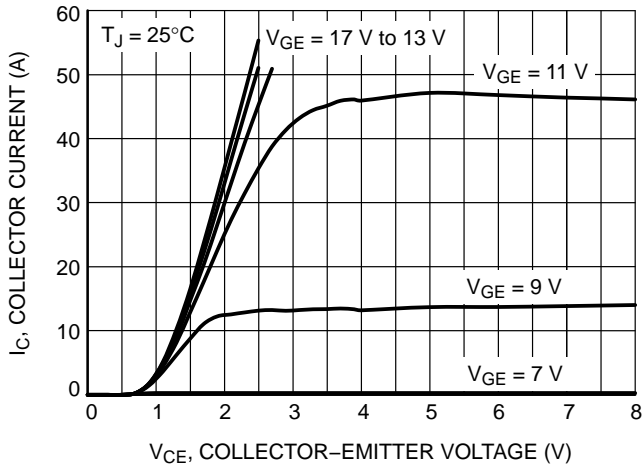

Figure 1. Output Characteristics

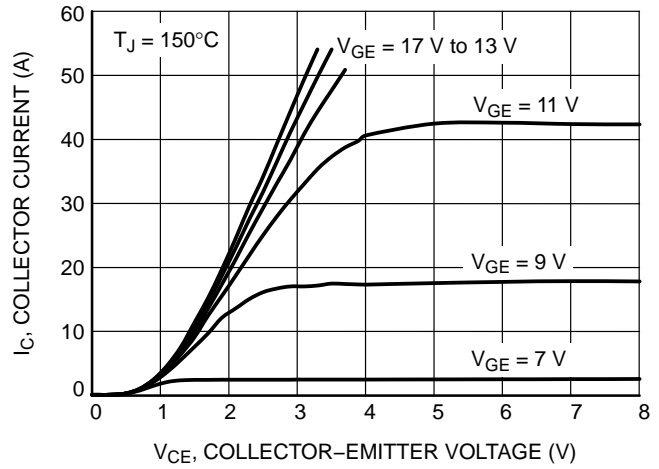

Figure 2. Output Characteristics

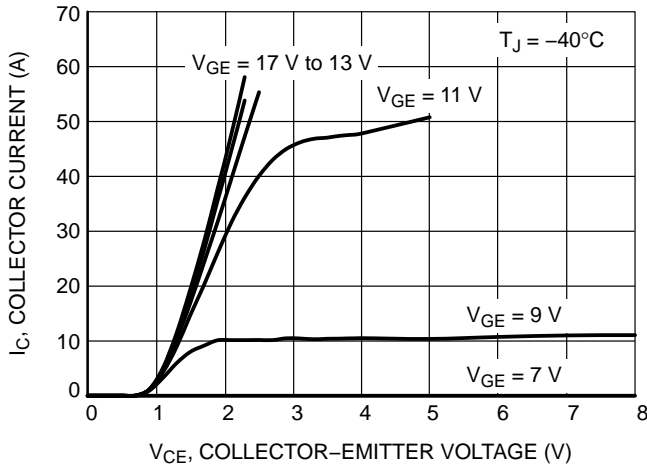

Figure 3. Output Characteristics

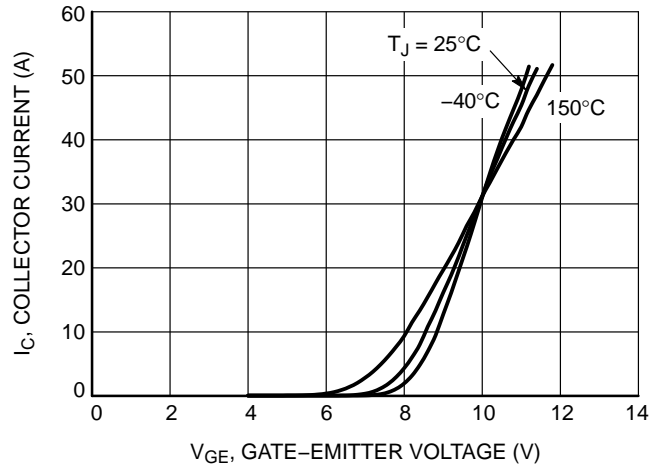

Figure 4. Typical Transfer Characteristics

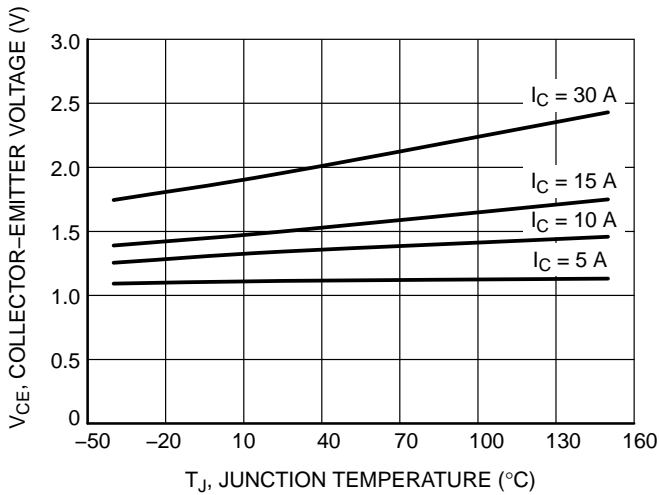

Figure 5. $V_{CE(sat)}$ vs. T_J

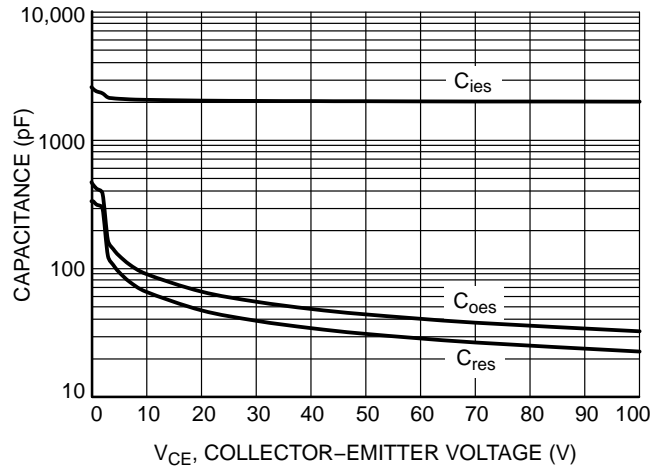

Figure 6. Typical Capacitance

NGTB15N60S1EG

TYPICAL CHARACTERISTICS

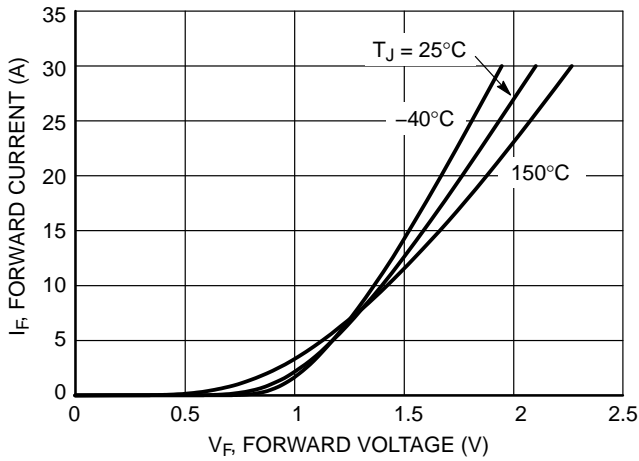

Figure 7. Diode Forward Characteristics

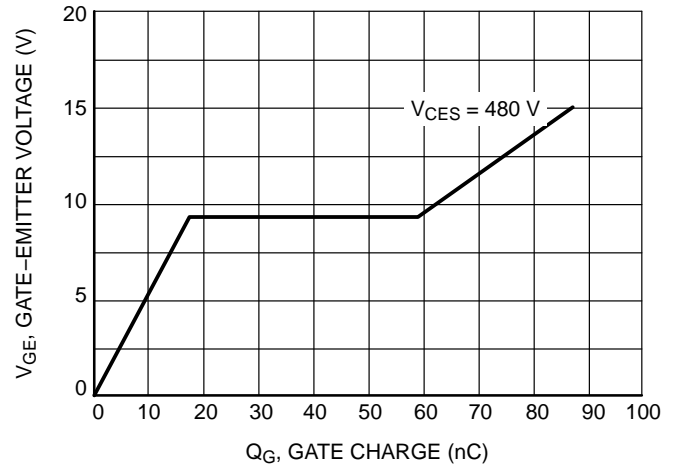

Figure 8. Typical Gate Charge

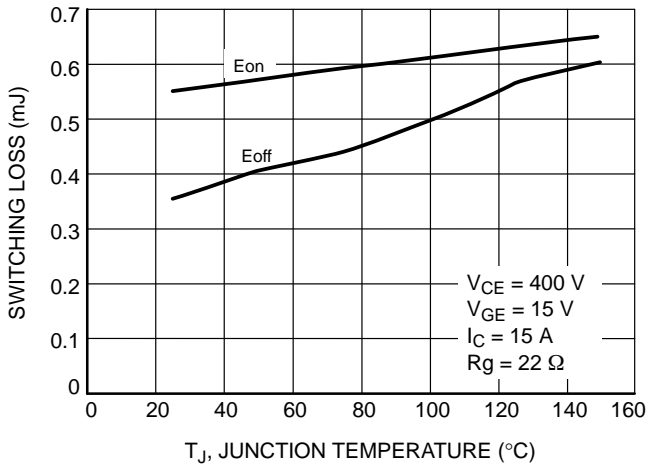

Figure 9. Switching Loss vs. Temperature

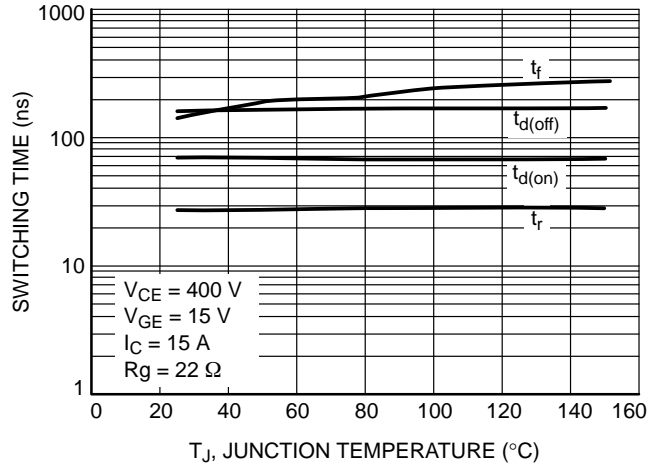

Figure 10. Switching Time vs. Temperature

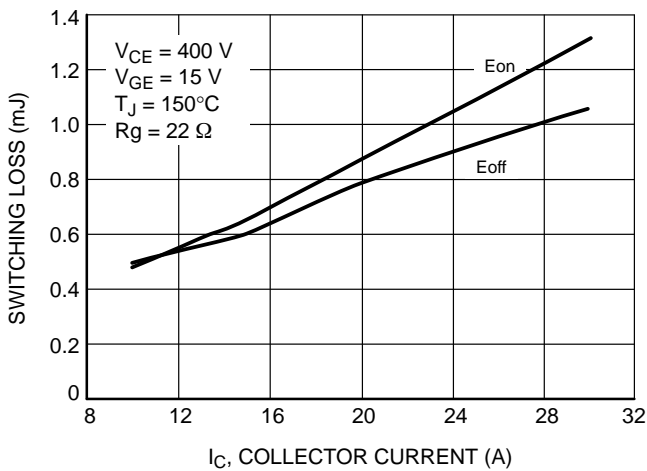

Figure 11. Switching Loss vs. I_C

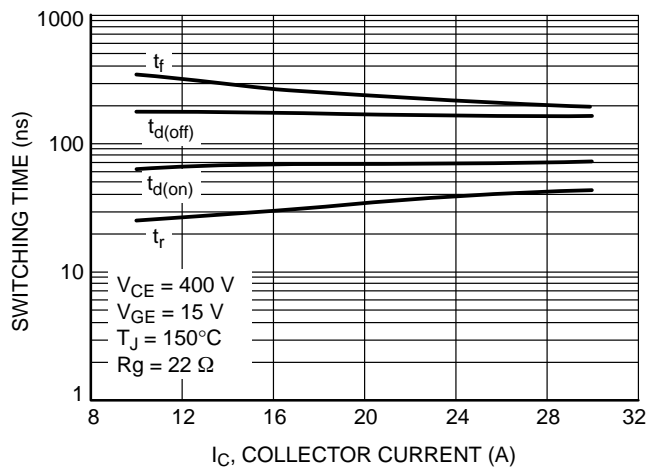

Figure 12. Switching Time vs. I_C

NGTB15N60S1EG

TYPICAL CHARACTERISTICS

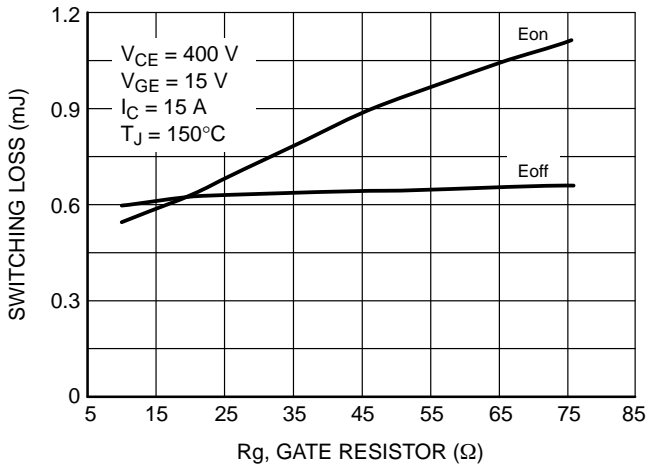

Figure 13. Switching Time vs. Rg

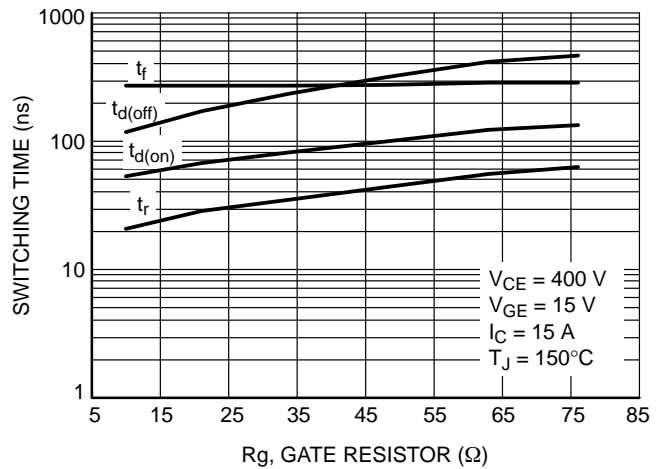

Figure 14. Switching Time vs. Rg

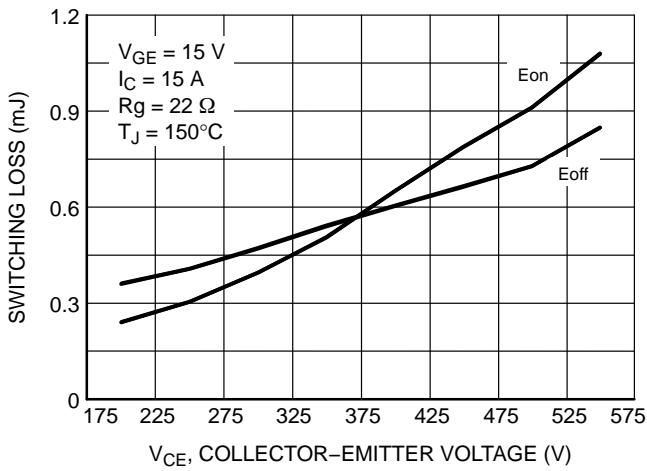

Figure 15. Switching Loss vs. V_{CE}

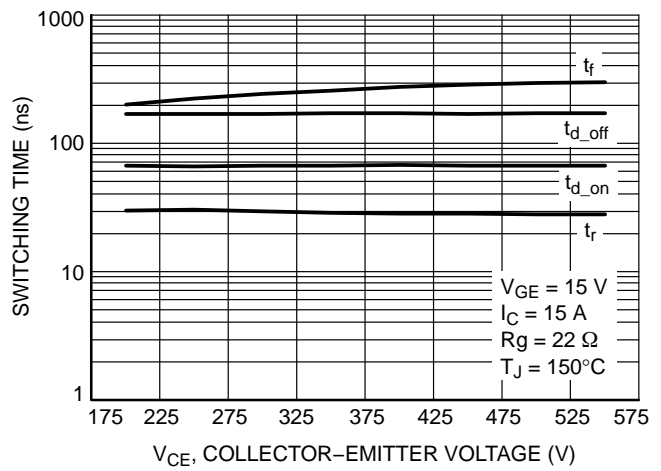

Figure 16. Switching Time vs. V_{CE}

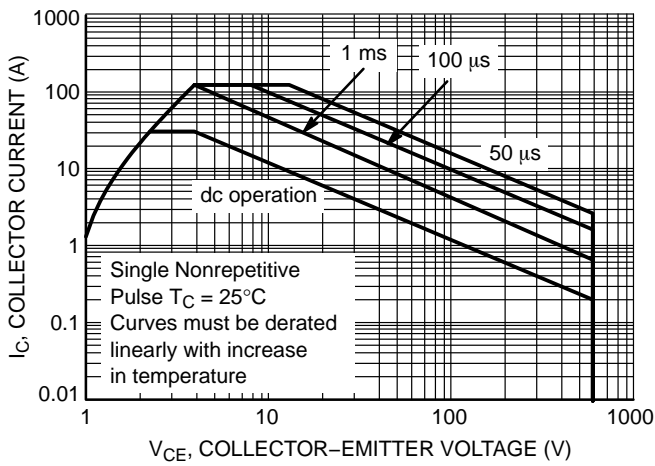

Figure 17. Safe Operating Area

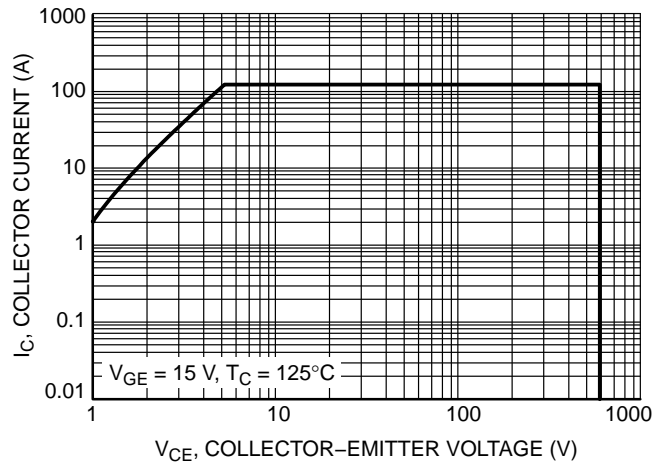

Figure 18. Reverse Bias Safe Operating Area

NGTB15N60S1EG

TYPICAL CHARACTERISTICS

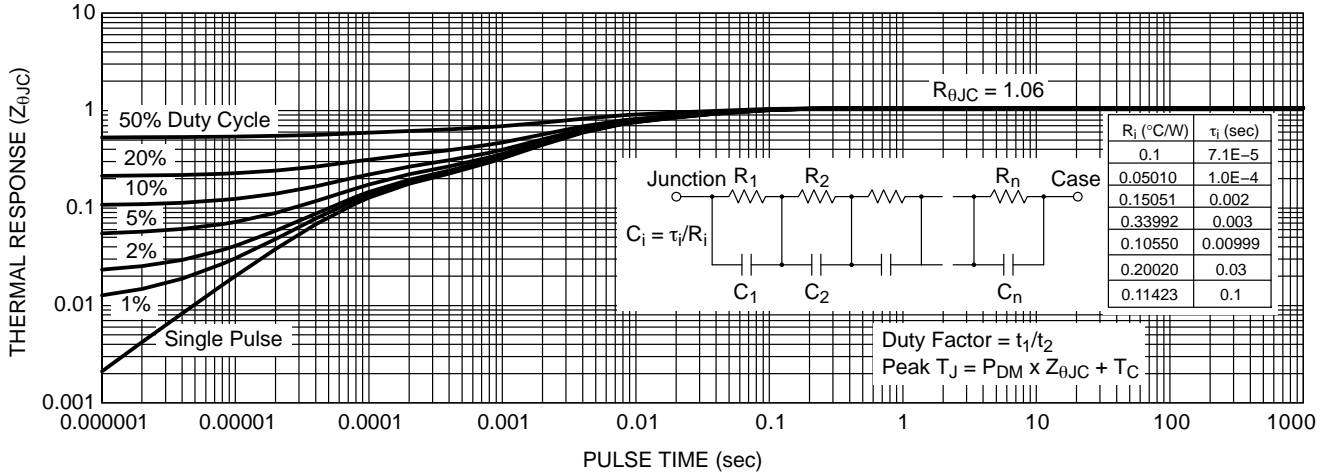

Figure 19. IGBT Transient Thermal Impedance

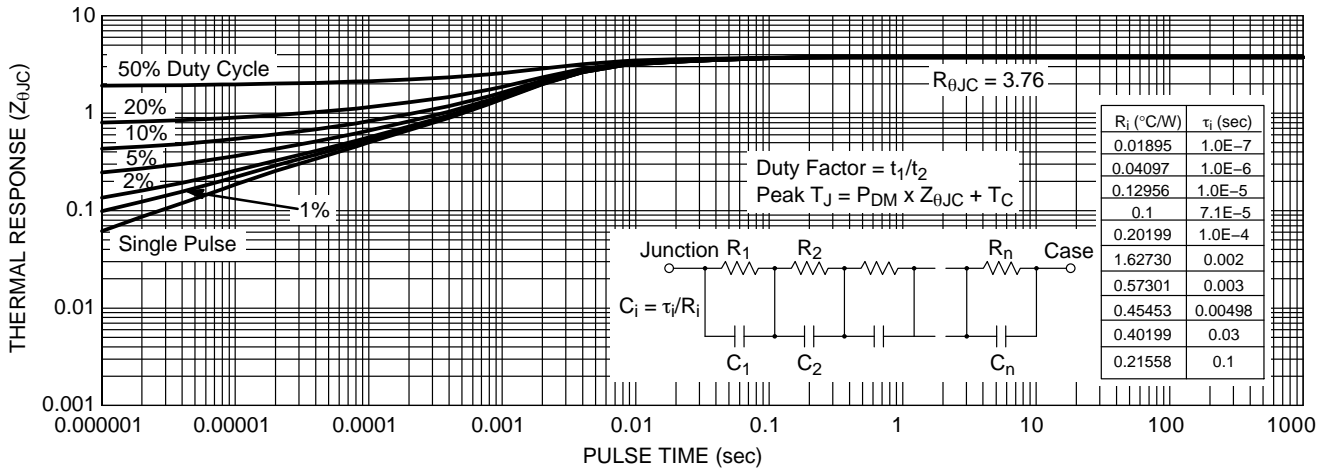

Figure 20. Diode Transient Thermal Impedance

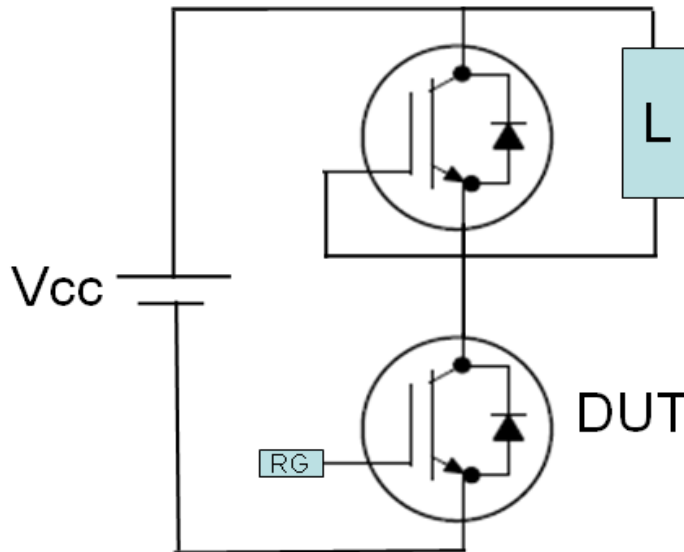

Figure 21. Test Circuit for Switching Characteristics

NGTB15N60S1EG



Figure 22. Definition of Turn On Waveform



Figure 23. Definition of Turn Off Waveform

onsemi, **Onsemi**, and other names, marks, and brands are registered and/or common law trademarks of Semiconductor Components Industries, LLC dba "**onsemi**" or its affiliates and/or subsidiaries in the United States and/or other countries. **onsemi** owns the rights to a number of patents, trademarks, copyrights, trade secrets, and other intellectual property. A listing of **onsemi**'s product/patent coverage may be accessed at www.onsemi.com/site/pdf/Patent-Marking.pdf. **onsemi** reserves the right to make changes at any time to any products or information herein, without notice. The information herein is provided "as-is" and **onsemi** makes no warranty, representation or guarantee regarding the accuracy of the information, product features, availability, functionality, or suitability of its products for any particular purpose, nor does **onsemi** assume any liability arising out of the application or use of any product or circuit, and specifically disclaims any and all liability, including without limitation special, consequential or incidental damages. Buyer is responsible for its products and applications using **onsemi** products, including compliance with all laws, regulations and safety requirements or standards, regardless of any support or applications information provided by **onsemi**. "Typical" parameters which may be provided in **onsemi** data sheets and/or specifications can and do vary in different applications and actual performance may vary over time. All operating parameters, including "Typicals" must be validated for each customer application by customer's technical experts. **onsemi** does not convey any license under any of its intellectual property rights nor the rights of others. **onsemi** products are not designed, intended, or authorized for use as a critical component in life support systems or any FDA Class 3 medical devices or medical devices with a same or similar classification in a foreign jurisdiction or any devices intended for implantation in the human body. Should Buyer purchase or use **onsemi** products for any such unintended or unauthorized application, Buyer shall indemnify and hold **onsemi** and its officers, employees, subsidiaries, affiliates, and distributors harmless against all claims, costs, damages, and expenses, and reasonable attorney fees arising out of, directly or indirectly, any claim of personal injury or death associated with such unintended or unauthorized use, even if such claim alleges that **onsemi** was negligent regarding the design or manufacture of the part. **onsemi** is an Equal Opportunity/Affirmative Action Employer. This literature is subject to all applicable copyright laws and is not for resale in any manner.

ADDITIONAL INFORMATION

TECHNICAL PUBLICATIONS:

Technical Library: www.onsemi.com/design/resources/technical-documentation
onsemi Website: www.onsemi.com

ONLINE SUPPORT: www.onsemi.com/support

For additional information, please contact your local Sales Representative at www.onsemi.com/support/sales

