

NID9N05ACL, NID9N05BCL

Power MOSFET

9.0 A, 52 V, N-Channel, Logic Level, Clamped MOSFET w/ESD Protection in a DPAK Package



ON Semiconductor®

www.onsemi.com

Benefits

- High Energy Capability for Inductive Loads
- Low Switching Noise Generation

Features

- Diode Clamp Between Gate and Source
- ESD Protection – HBM 5000 V
- Active Over-Voltage Gate to Drain Clamp
- Scalable to Lower or Higher $R_{DS(on)}$
- Internal Series Gate Resistance
- AEC-Q101 Qualified and PPAP Capable
- These Devices are Pb-Free, Halogen Free/BFR Free and are RoHS Compliant

Applications

- Automotive and Industrial Markets:
Solenoid Drivers, Lamp Drivers, Small Motor Drivers

MAXIMUM RATINGS ($T_J = 25^\circ\text{C}$ unless otherwise noted)

Rating	Symbol	Value	Unit
Drain-to-Source Voltage Internally Clamped	V_{DSS}	52–59	V
Gate-to-Source Voltage – Continuous	V_{GS}	± 15	V
Drain Current – Continuous @ $T_A = 25^\circ\text{C}$ – Single Pulse ($t_p = 10 \mu\text{s}$)	I_D I_{DM}	9.0 35	A
Total Power Dissipation @ $T_A = 25^\circ\text{C}$	P_D	1.74	W
Operating and Storage Temperature Range	T_J, T_{stg}	–55 to 175	$^\circ\text{C}$
Single Pulse Drain-to-Source Avalanche Energy – Starting $T_J = 125^\circ\text{C}$ ($V_{DD} = 50 \text{ V}$, $I_{D(pk)} = 1.5 \text{ A}$, $V_{GS} = 10 \text{ V}$, $R_G = 25 \Omega$)	E_{AS}	160	mJ
Thermal Resistance, Junction-to-Case Junction-to-Ambient (Note 1) Junction-to-Ambient (Note 2)	$R_{\theta JC}$ $R_{\theta JA}$ $R_{\theta JA}$	5.2 72 100	$^\circ\text{C/W}$
Maximum Lead Temperature for Soldering Purposes, 1/8" from Case for 10 seconds	T_L	260	$^\circ\text{C}$

Stresses exceeding those listed in the Maximum Ratings table may damage the device. If any of these limits are exceeded, device functionality should not be assumed, damage may occur and reliability may be affected.

1. When surface mounted to a FR4 board using 1" pad size, (Cu area 1.127 in²).
2. When surface mounted to a FR4 board using minimum recommended pad size, (Cu area 0.412 in²).

V_{DSS} (Clamped)	$R_{DS(on)}$ TYP	I_D MAX (Limited)
52 V	90 m Ω	9.0 A

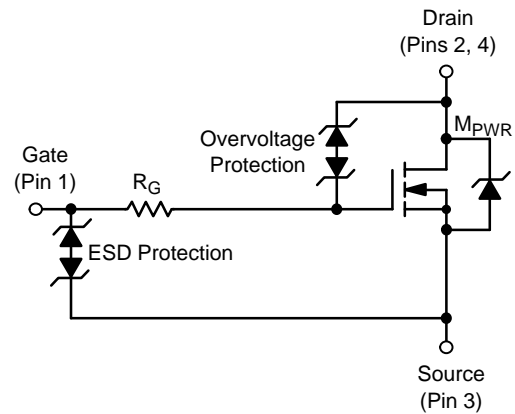

DPAK
CASE 369C
STYLE 2

MARKING DIAGRAM

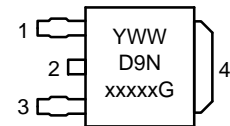

Y	= Year	1	= Gate
WW	= Work Week	2	= Drain
xxxxx	= 05ACL or 05BCL	3	= Source
G	= Pb-Free Package	4	= Drain

ORDERING INFORMATION

Device	Package	Shipping†
NID9N05ACL4G	DPAK (Pb-Free)	2500/Tape & Reel
NID9N05BCL4G	DPAK (Pb-Free)	2500/Tape & Reel

†For information on tape and reel specifications, including part orientation and tape sizes, please refer to our Tape and Reel Packaging Specification Brochure, BRD8011/D.

NID9N05ACL, NID9N05BCL

ELECTRICAL CHARACTERISTICS (T_J = 25°C unless otherwise noted)

Characteristic	Symbol	Min	Typ	Max	Unit
----------------	--------	-----	-----	-----	------

OFF CHARACTERISTICS

Drain-to-Source Breakdown Voltage (Note 3) (V _{GS} = 0 V, I _D = 1.0 mA, T _J = 25°C) (V _{GS} = 0 V, I _D = 1.0 mA, T _J = -40°C to 125°C) Temperature Coefficient (Negative)	V _{(BR)DSS}	52 50.8 -	55 54 -10	59 59.5 -	V V mV/°C
Zero Gate Voltage Drain Current (V _{DS} = 40 V, V _{GS} = 0 V) (V _{DS} = 40 V, V _{GS} = 0 V, T _J = 125°C)	I _{DSS}	- -	- -	10 25	μA
Gate-Body Leakage Current (V _{GS} = ±8 V, V _{DS} = 0 V) (V _{GS} = ±14 V, V _{DS} = 0 V)	I _{GSS}	- -	- ±22	±10 -	μA

ON CHARACTERISTICS (Note 3)

Gate Threshold Voltage (Note 3) (V _{DS} = V _{GS} , I _D = 100 μA) Threshold Temperature Coefficient (Negative)	V _{GS(th)}	1.3 -	1.75 -4.5	2.5 -	V mV/°C
Static Drain-to-Source On-Resistance (Note 3) (V _{GS} = 4.0 V, I _D = 1.5 A) (V _{GS} = 3.5 V, I _D = 0.6 A) (V _{GS} = 3.0 V, I _D = 0.2 A) (V _{GS} = 12 V, I _D = 9.0 A) (V _{GS} = 12 V, I _D = 12 A)	R _{DS(on)}	- - - 70 67	153 175 - 90 95	181 364 1210 - -	mΩ
Forward Transconductance (Note 3) (V _{DS} = 15 V, I _D = 9.0 A)	g _{FS}	-	24	-	Mhos

DYNAMIC CHARACTERISTICS

Input Capacitance	(V _{DS} = 40 V, V _{GS} = 0 V, f = 10 kHz)	C _{iss}	-	155	250	pF
Output Capacitance		C _{oss}	-	60	100	
Transfer Capacitance		C _{rss}	-	25	40	
Input Capacitance	(V _{DS} = 25 V, V _{GS} = 0 V, f = 10 kHz)	C _{iss}	-	175	-	pF
Output Capacitance		C _{oss}	-	70	-	
Transfer Capacitance		C _{rss}	-	30	-	

SWITCHING CHARACTERISTICS (Note 4)

Turn-On Delay Time	(V _{GS} = 10 V, V _{DD} = 40 V, I _D = 9.0 A, R _G = 9.0 Ω)	t _{d(on)}	-	130	200	ns
Rise Time		t _r	-	500	750	
Turn-Off Delay Time		t _{d(off)}	-	1300	2000	
Fall Time		t _f	-	1150	1850	
Turn-On Delay Time	(V _{GS} = 10 V, V _{DD} = 15 V, I _D = 1.5 A, R _G = 2 kΩ)	t _{d(on)}	-	200	-	ns
Rise Time		t _r	-	500	-	
Turn-Off Delay Time		t _{d(off)}	-	2500	-	
Fall Time		t _f	-	1800	-	
Turn-On Delay Time	(V _{GS} = 10 V, V _{DD} = 15 V, I _D = 1.5 A, R _G = 50 Ω)	t _{d(on)}	-	120	-	ns
Rise Time		t _r	-	275	-	
Turn-Off Delay Time		t _{d(off)}	-	1600	-	
Fall Time		t _f	-	1100	-	
Gate Charge	(V _{GS} = 4.5 V, V _{DS} = 40 V, I _D = 9.0 A) (Note 3)	Q _T	-	4.5	7.0	nC
		Q ₁	-	1.2	-	
		Q ₂	-	2.7	-	

Product parametric performance is indicated in the Electrical Characteristics for the listed test conditions, unless otherwise noted. Product performance may not be indicated by the Electrical Characteristics if operated under different conditions.

3. Pulse Test: Pulse Width ≤ 300 μs, Duty Cycle ≤ 2%.
4. Switching characteristics are independent of operating junction temperatures.

NID9N05ACL, NID9N05BCL

ELECTRICAL CHARACTERISTICS (T_J = 25°C unless otherwise noted)

Characteristic	Symbol	Min	Typ	Max	Unit
----------------	--------	-----	-----	-----	------

SWITCHING CHARACTERISTICS (Note 4)

Gate Charge	(V _{GS} = 4.5 V, V _{DS} = 15 V, I _D = 1.5 A) (Note 3)	Q _T	–	3.6	–	nC
		Q ₁	–	1.0	–	
		Q ₂	–	2.0	–	

SOURCE–DRAIN DIODE CHARACTERISTICS

Forward On–Voltage	(I _S = 4.5 A, V _{GS} = 0 V) (Note 3) (I _S = 4.0 A, V _{GS} = 0 V) (I _S = 4.5 A, V _{GS} = 0 V, T _J = 125°C)	V _{SD}	–	0.86 0.845 0.725	1.2 – –	V
Reverse Recovery Time	(I _S = 4.5 A, V _{GS} = 0 V, di _S /dt = 100 A/μs) (Note 3)	t _{rr}	–	700	–	ns
		t _a	–	200	–	
		t _b	–	500	–	
Reverse Recovery Stored Charge		Q _{RR}	–	6.5	–	μC

ESD CHARACTERISTICS

Electro–Static Discharge Capability	Human Body Model (HBM)	ESD	5000	–	–	V
	Machine Model (MM)		500	–	–	

Product parametric performance is indicated in the Electrical Characteristics for the listed test conditions, unless otherwise noted. Product performance may not be indicated by the Electrical Characteristics if operated under different conditions.

3. Pulse Test: Pulse Width ≤ 300 μs, Duty Cycle ≤ 2%.
4. Switching characteristics are independent of operating junction temperatures.

NID9N05ACL, NID9N05BCL

TYPICAL PERFORMANCE CURVES

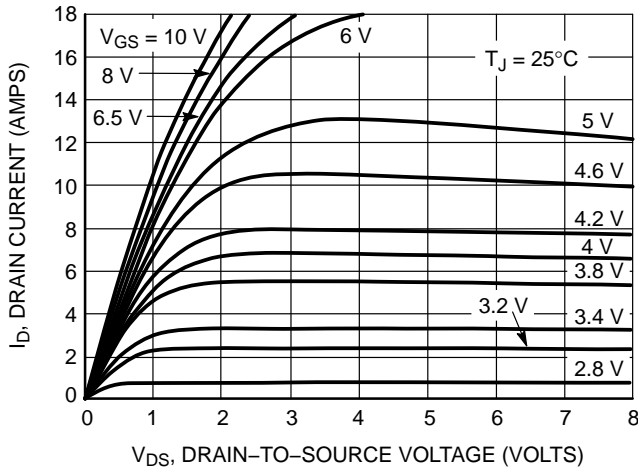

Figure 1. On-Region Characteristics

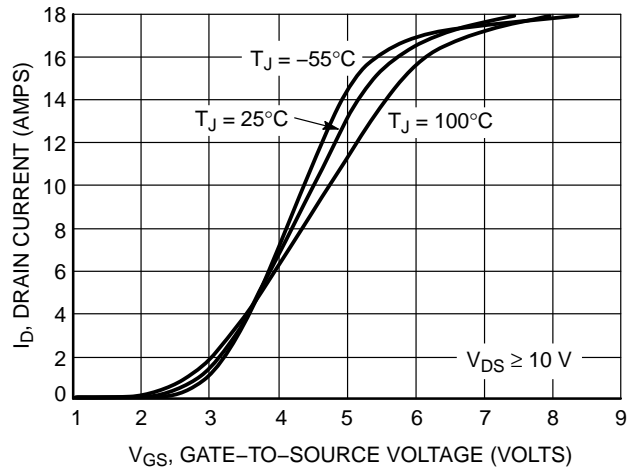

Figure 2. Transfer Characteristics

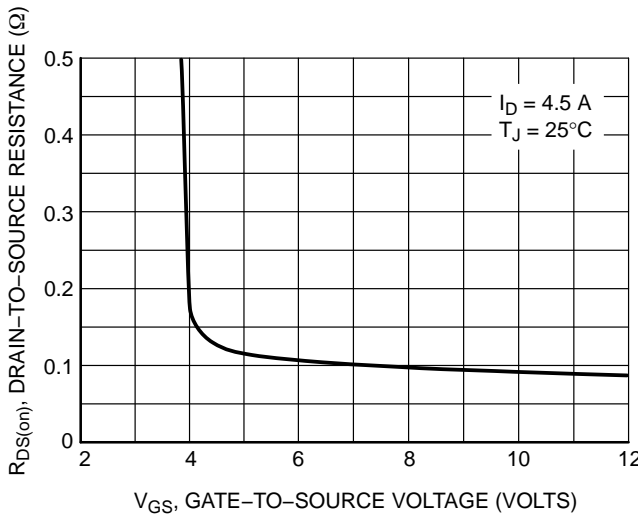

Figure 3. On-Resistance versus Gate-to-Source Voltage

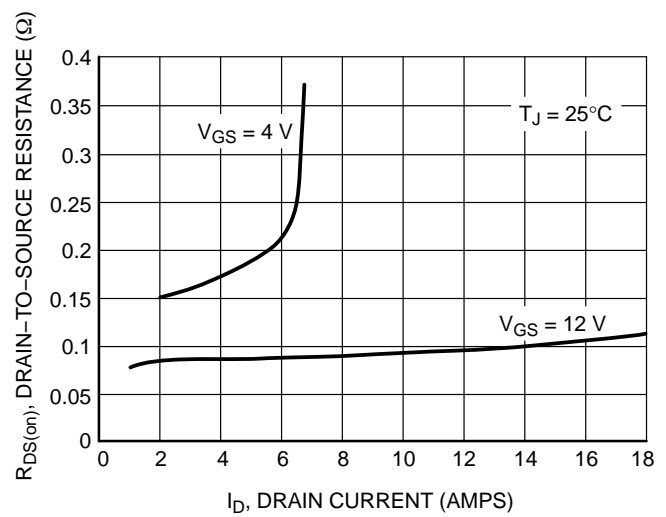

Figure 4. On-Resistance versus Drain Current and Gate Voltage

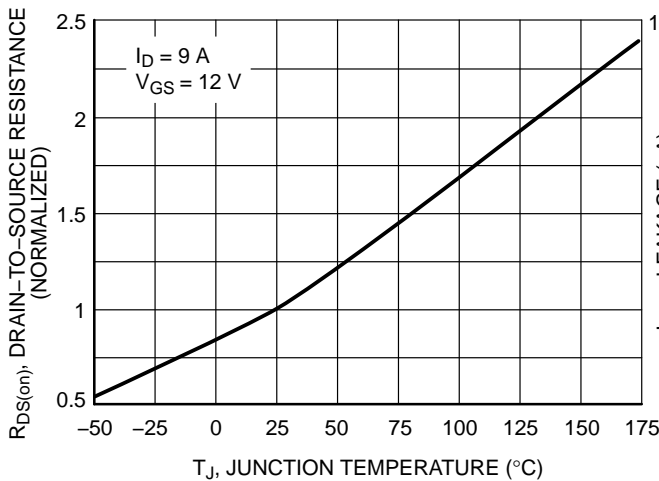

Figure 5. On-Resistance Variation with Temperature

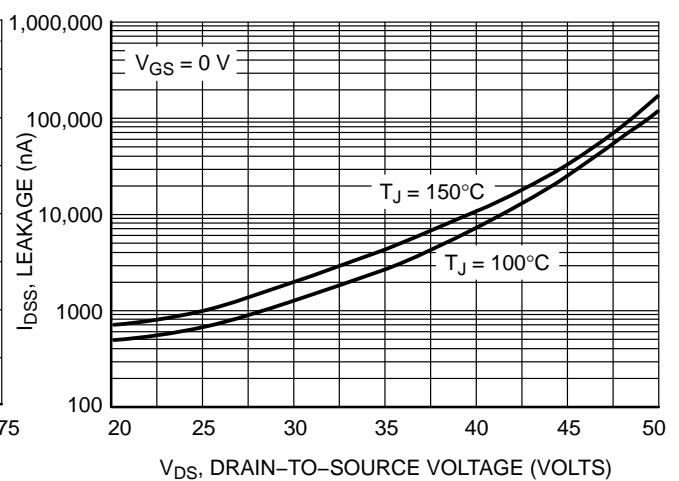

Figure 6. Drain-to-Source Leakage Current versus Voltage

NID9N05ACL, NID9N05BCL

TYPICAL PERFORMANCE CURVES

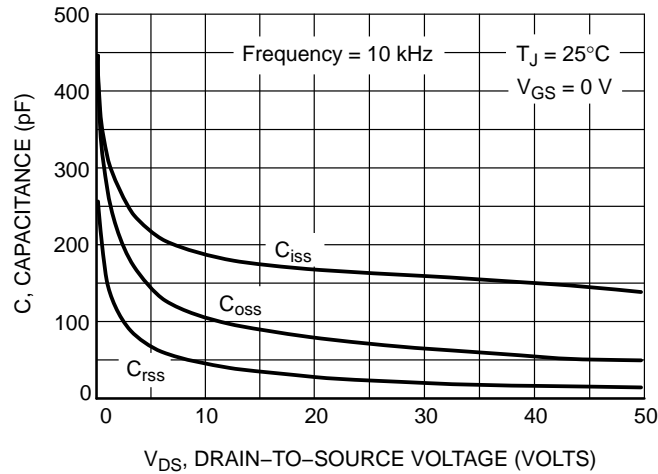

Figure 7. Capacitance Variation

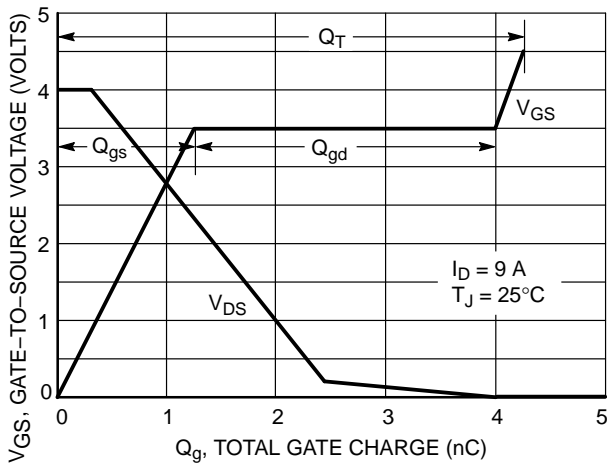

Figure 8. Gate-To-Source and Drain-To-Source Voltage versus Total Charge

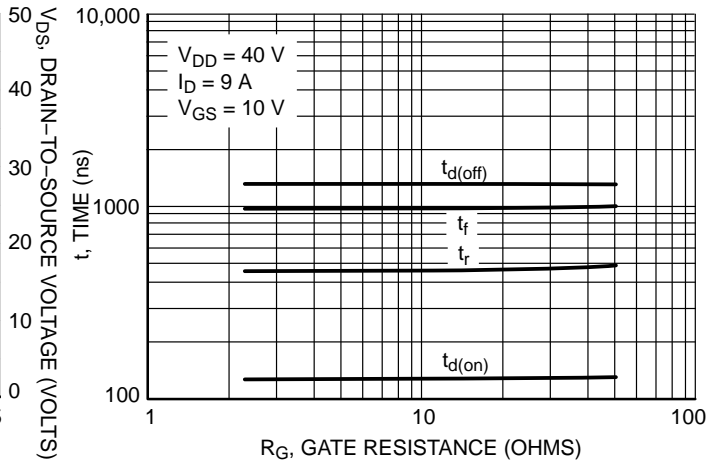

Figure 9. Resistive Switching Time Variation versus Gate Resistance

DRAIN-TO-SOURCE DIODE CHARACTERISTICS

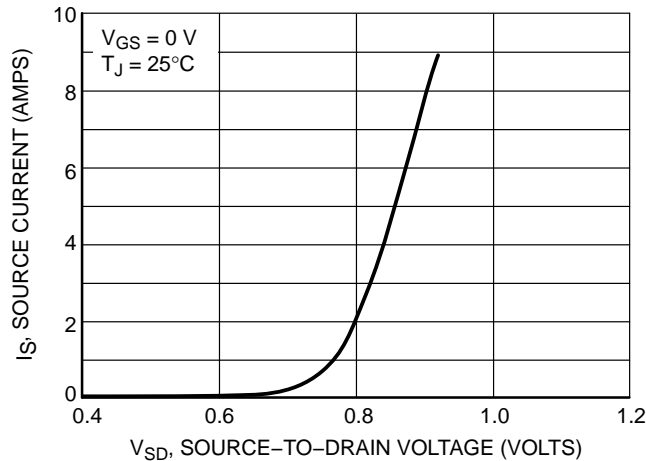

Figure 10. Diode Forward Voltage versus Current

NID9N05ACL, NID9N05BCL

SAFE OPERATING AREA

The Forward Biased Safe Operating Area curves define the maximum simultaneous drain-to-source voltage and drain current that a transistor can handle safely when it is forward biased. Curves are based upon maximum peak junction temperature and a case temperature (T_C) of 25°C. Peak repetitive pulsed power limits are determined by using the thermal response data in conjunction with the procedures discussed in AN569, "Transient Thermal Resistance – General Data and Its Use."

Switching between the off-state and the on-state may traverse any load line provided neither rated peak current (I_{DM}) nor rated voltage (V_{DSS}) is exceeded and the transition time (t_r, t_f) do not exceed 10 μ s. In addition the total power averaged over a complete switching cycle must not exceed $(T_{J(MAX)} - T_C)/(R_{\theta JC})$.

A Power MOSFET designated E-FET can be safely used in switching circuits with unclamped inductive loads. For

reliable operation, the stored energy from circuit inductance dissipated in the transistor while in avalanche must be less than the rated limit and adjusted for operating conditions differing from those specified. Although industry practice is to rate in terms of energy, avalanche energy capability is not a constant. The energy rating decreases non-linearly with an increase of peak current in avalanche and peak junction temperature.

Although many E-FETs can withstand the stress of drain-to-source avalanche at currents up to rated pulsed current (I_{DM}), the energy rating is specified at rated continuous current (I_D), in accordance with industry custom. The energy rating must be derated for temperature as shown in the accompanying graph (Figure 12). Maximum energy at currents below rated continuous I_D can safely be assumed to equal the values indicated.

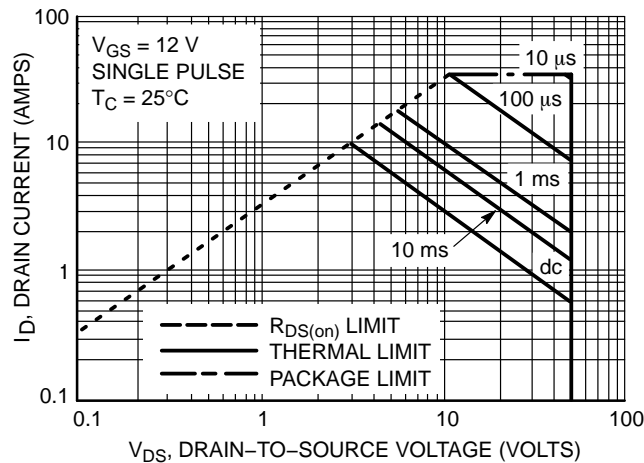

Figure 11. Maximum Rated Forward Biased Safe Operating Area

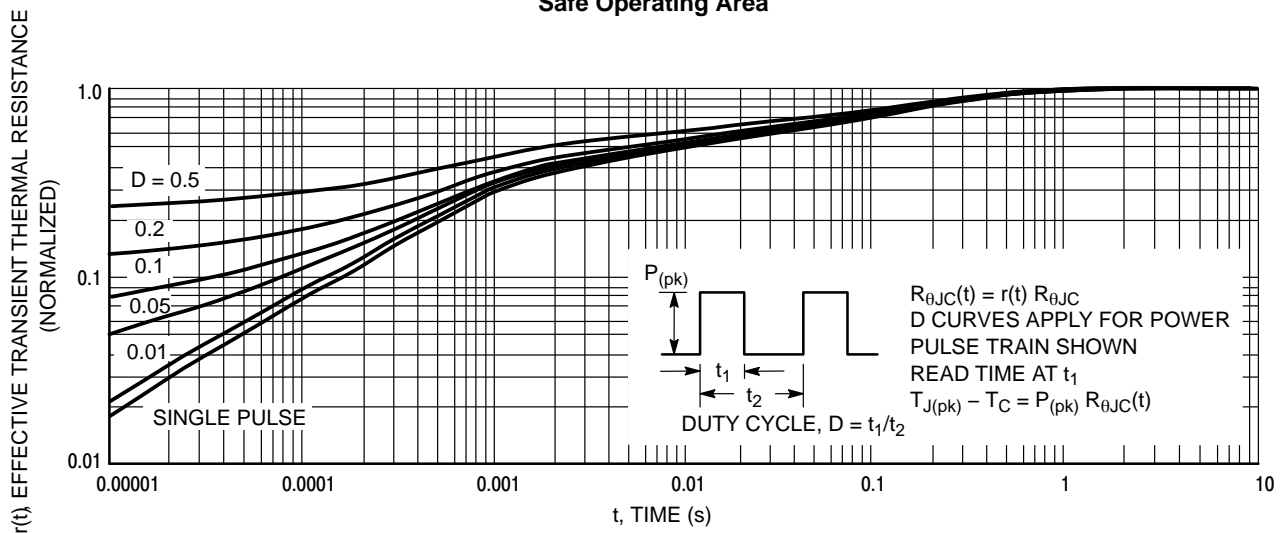

Figure 12. Thermal Response

onsemi, **Onsemi**, and other names, marks, and brands are registered and/or common law trademarks of Semiconductor Components Industries, LLC dba "**onsemi**" or its affiliates and/or subsidiaries in the United States and/or other countries. **onsemi** owns the rights to a number of patents, trademarks, copyrights, trade secrets, and other intellectual property. A listing of **onsemi**'s product/patent coverage may be accessed at www.onsemi.com/site/pdf/Patent-Marking.pdf. **onsemi** reserves the right to make changes at any time to any products or information herein, without notice. The information herein is provided "as-is" and **onsemi** makes no warranty, representation or guarantee regarding the accuracy of the information, product features, availability, functionality, or suitability of its products for any particular purpose, nor does **onsemi** assume any liability arising out of the application or use of any product or circuit, and specifically disclaims any and all liability, including without limitation special, consequential or incidental damages. Buyer is responsible for its products and applications using **onsemi** products, including compliance with all laws, regulations and safety requirements or standards, regardless of any support or applications information provided by **onsemi**. "Typical" parameters which may be provided in **onsemi** data sheets and/or specifications can and do vary in different applications and actual performance may vary over time. All operating parameters, including "Typicals" must be validated for each customer application by customer's technical experts. **onsemi** does not convey any license under any of its intellectual property rights nor the rights of others. **onsemi** products are not designed, intended, or authorized for use as a critical component in life support systems or any FDA Class 3 medical devices or medical devices with a same or similar classification in a foreign jurisdiction or any devices intended for implantation in the human body. Should Buyer purchase or use **onsemi** products for any such unintended or unauthorized application, Buyer shall indemnify and hold **onsemi** and its officers, employees, subsidiaries, affiliates, and distributors harmless against all claims, costs, damages, and expenses, and reasonable attorney fees arising out of, directly or indirectly, any claim of personal injury or death associated with such unintended or unauthorized use, even if such claim alleges that **onsemi** was negligent regarding the design or manufacture of the part. **onsemi** is an Equal Opportunity/Affirmative Action Employer. This literature is subject to all applicable copyright laws and is not for resale in any manner.

ADDITIONAL INFORMATION

TECHNICAL PUBLICATIONS:

Technical Library: www.onsemi.com/design/resources/technical-documentation
onsemi Website: www.onsemi.com

ONLINE SUPPORT: www.onsemi.com/support

For additional information, please contact your local Sales Representative at www.onsemi.com/support/sales