

# NJL4281D (NPN) NJL4302D (PNP)

## Complementary ThermalTrak™ Transistors

The ThermalTrak family of devices has been designed to eliminate thermal equilibrium lag time and bias trimming in audio amplifier applications. They can also be used in other applications as transistor die protection devices.

### Features

- Thermally Matched Bias Diode
- Instant Thermal Bias Tracking
- Absolute Thermal Integrity
- High Safe Operating Area
- Pb-Free Packages are Available\*

### Benefits

- Eliminates Thermal Equilibrium Lag Time and Bias Trimming
- Superior Sound Quality Through Improved Dynamic Temperature Response
- Significantly Improved Bias Stability
- Simplified Assembly
  - ◆ Reduced Labor Costs
  - ◆ Reduced Component Count
- High Reliability

### Applications

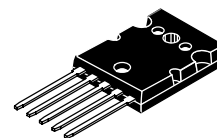
- High-End Consumer Audio Products
  - ◆ Home Amplifiers
  - ◆ Home Receivers
- Professional Audio Amplifiers
  - ◆ Theater and Stadium Sound Systems
  - ◆ Public Address Systems (PAs)



**ON Semiconductor®**

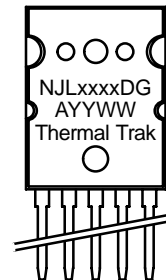
<http://onsemi.com>

**BIPOLAR POWER  
TRANSISTORS**  
**15 AMP, 350 VOLT, 230 WATT**

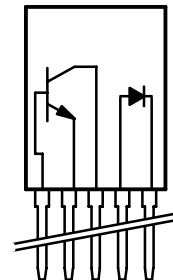


TO-264, 5 LEAD  
CASE 340AA  
STYLE 1

### MARKING DIAGRAM



### SCHEMATIC



NJLxxxxD = Device Code  
           xxxx = 4281 or 4302  
 G = Pb-Free Package  
 A = Assembly Location  
 YY = Year  
 WW = Work Week

### ORDERING INFORMATION

Device	Package	Shipping
NJL4281D	TO-264	25 Units / Rail
NJL4281DG	TO-264 (Pb-Free)	25 Units / Rail
NJL4302D	TO-264	25 Units / Rail
NJL4302DG	TO-264 (Pb-Free)	25 Units / Rail

\*For additional information on our Pb-Free strategy and soldering details, please download the ON Semiconductor Soldering and Mounting Techniques Reference Manual, SOLDERRM/D.

## NJL4281D (NPN) NJL4302D (PNP)

### MAXIMUM RATINGS (T<sub>J</sub> = 25°C unless otherwise noted)

Rating	Symbol	Value	Unit
Collector–Emitter Voltage	V <sub>CEO</sub>	350	Vdc
Collector–Base Voltage	V <sub>CBO</sub>	350	Vdc
Emitter–Base Voltage	V <sub>EBO</sub>	5	Vdc
Collector–Emitter Voltage – 1.5 V	V <sub>CEX</sub>	350	Vdc
Collector Current – Continuous – Peak (Note 1)	I <sub>C</sub>	15 30	Adc
Base Current – Continuous	I <sub>B</sub>	1.5	Adc
Total Power Dissipation @ T <sub>C</sub> = 25°C Derate Above 25°C	P <sub>D</sub>	230 1.84	W W/°C
Operating and Storage Junction Temperature Range	T <sub>J</sub> , T <sub>stg</sub>	– 65 to +150	°C
DC Blocking Voltage	V <sub>R</sub>	200	V
Average Rectified Forward Current	I <sub>F(AV)</sub>	1.0	A

### THERMAL CHARACTERISTICS

Characteristic	Symbol	Max	Unit
Thermal Resistance, Junction–to–Case	R <sub>θJC</sub>	0.54	°C/W

Stresses exceeding Maximum Ratings may damage the device. Maximum Ratings are stress ratings only. Functional operation above the Recommended Operating Conditions is not implied. Extended exposure to stresses above the Recommended Operating Conditions may affect device reliability.

1. Pulse Test: Pulse Width = 5 ms, Duty Cycle < 10%.

### ATTRIBUTES

Characteristic	Value
ESD Protection Human Body Model Machine Model	>8000 V > 400 V
Flammability Rating	UL 94 V–0 @ 0.125 in

# NJL4281D (NPN) NJL4302D (PNP)

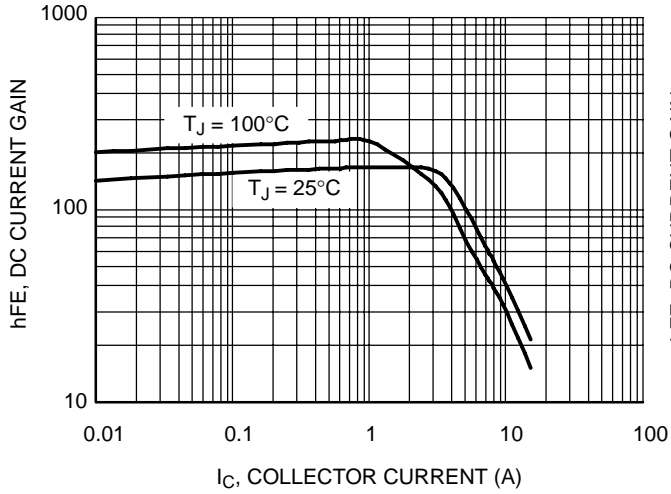
## ELECTRICAL CHARACTERISTICS (T<sub>C</sub> = 25°C unless otherwise noted)

Characteristic	Symbol	Min	Max	Unit
<b>OFF CHARACTERISTICS</b>				
Collector Emitter Sustaining Voltage (I <sub>C</sub> = 50 mA, I <sub>B</sub> = 0)	V <sub>CE(sus)</sub>	350	–	Vdc
Collector Cut-off Current (V <sub>CE</sub> = 200 V, I <sub>B</sub> = 0)	I <sub>CEO</sub>	–	100	μAdc
Collector Cutoff Current (V <sub>CB</sub> = 350 Vdc, I <sub>E</sub> = 0)	I <sub>CBO</sub>	–	50	μAdc
Emitter Cutoff Current (V <sub>EB</sub> = 5.0 Vdc, I <sub>C</sub> = 0)	I <sub>EBO</sub>	–	5.0	μAdc
<b>SECOND BREAKDOWN</b>				
Second Breakdown Collector with Base Forward Biased (V <sub>CE</sub> = 50 Vdc, t = 1.0 s (non-repetitive)) (V <sub>CE</sub> = 100 Vdc, t = 1.0 s (non-repetitive))	I <sub>S/b</sub>	4.5 1.0	– –	Adc
<b>ON CHARACTERISTICS</b>				
DC Current Gain (I <sub>C</sub> = 100 mAdc, V <sub>CE</sub> = 5.0 Vdc) (I <sub>C</sub> = 1.0 Adc, V <sub>CE</sub> = 5.0 Vdc) (I <sub>C</sub> = 3.0 Adc, V <sub>CE</sub> = 5.0 Vdc) (I <sub>C</sub> = 5.0 Adc, V <sub>CE</sub> = 5.0 Vdc) (I <sub>C</sub> = 8.0 Adc, V <sub>CE</sub> = 5.0 Vdc) (I <sub>C</sub> = 15 Adc, V <sub>CE</sub> = 5.0 Vdc)	h <sub>FE</sub>	80 80 80 80 40 10	250 250 250 250 – –	–
Collector–Emitter Saturation Voltage (I <sub>C</sub> = 8.0 Adc, I <sub>B</sub> = 0.8 Adc)	V <sub>CE(sat)</sub>	–	1.0	Vdc
Emitter–Base Saturation Voltage (I <sub>C</sub> = 8.0 Adc, I <sub>B</sub> = 0.8 A)	V <sub>BE(sat)</sub>	–	1.4	Vdc
Base–Emitter ON Voltage (I <sub>C</sub> = 8.0 Adc, V <sub>CE</sub> = 5.0 Vdc)	V <sub>BE(on)</sub>	–	1.5	Vdc
<b>DYNAMIC CHARACTERISTICS</b>				
Current–Gain – Bandwidth Product (I <sub>C</sub> = 1.0 Adc, V <sub>CE</sub> = 5.0 Vdc, f <sub>test</sub> = 1.0 MHz)	f <sub>T</sub>	35	–	MHz
Output Capacitance (V <sub>CB</sub> = 10 Vdc, I <sub>E</sub> = 0, f <sub>test</sub> = 1.0 MHz)	C <sub>ob</sub>	–	600	pF
Maximum Instantaneous Forward Voltage (Note 2) (i <sub>F</sub> = 1.0 A, T <sub>J</sub> = 25°C) (i <sub>F</sub> = 1.0 A, T <sub>J</sub> = 150°C)	V <sub>F</sub>		1.1 0.93	V
Maximum Instantaneous Reverse Current (Note 2) (Rated dc Voltage, T <sub>J</sub> = 25°C) (Rated dc Voltage, T <sub>J</sub> = 150°C)	i <sub>R</sub>		10 100	μA
Maximum Reverse Recovery Time (i <sub>F</sub> = 1.0 A, di/dt = 50 A/μs)	t <sub>rr</sub>		100	ns

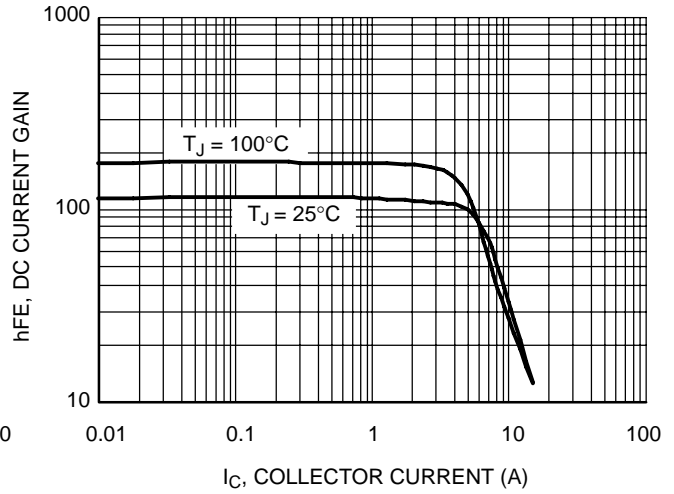
2. Diode Pulse Test: Pulse Width = 300 μs, Duty Cycle ≤ 2.0%.

# NJL4281D (NPN) NJL4302D (PNP)

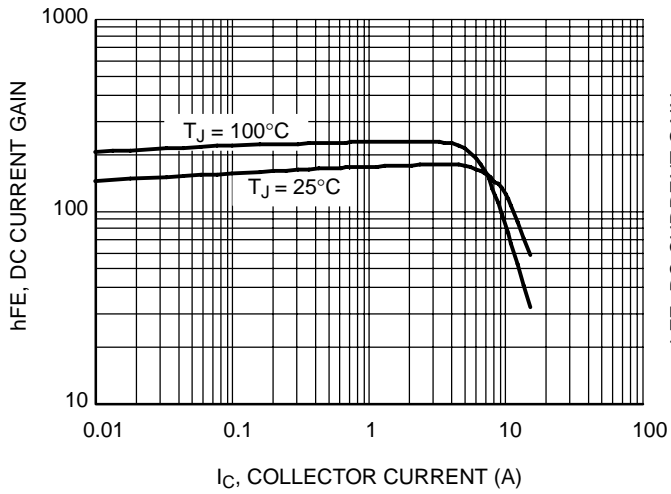
## TYPICAL CHARACTERISTICS



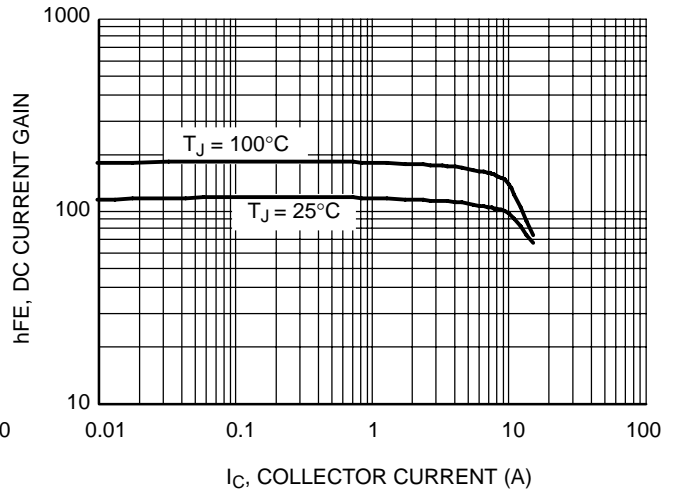
**Figure 1. DC Current Gain,  $V_{CE} = 5\text{ V}$ , NPN NJL4281D**



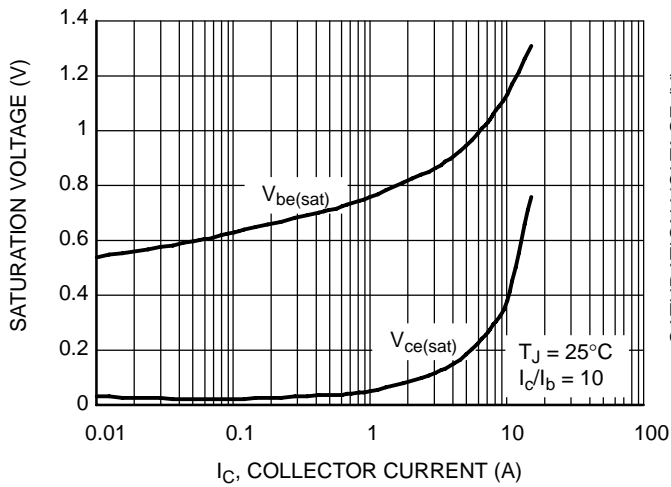
**Figure 2. DC Current Gain,  $V_{CE} = 5\text{ V}$ , PNP NJL4302D**



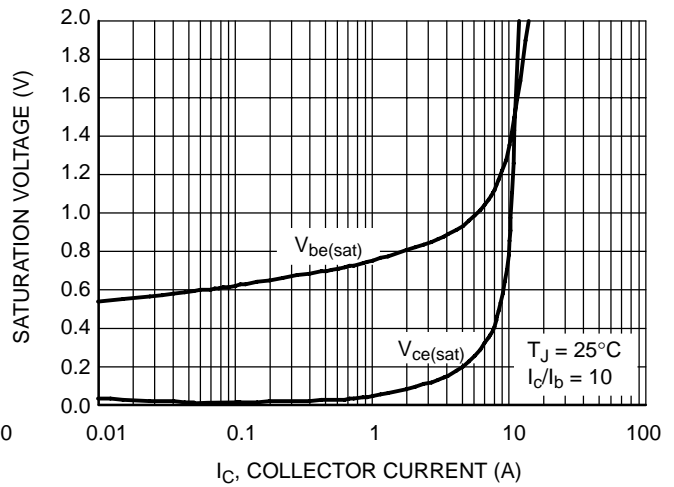
**Figure 3. DC Current Gain,  $V_{CE} = 20\text{ V}$ , NPN NJL4281D**



**Figure 4. DC Current Gain,  $V_{CE} = 20\text{ V}$ , PNP NJL4302D**



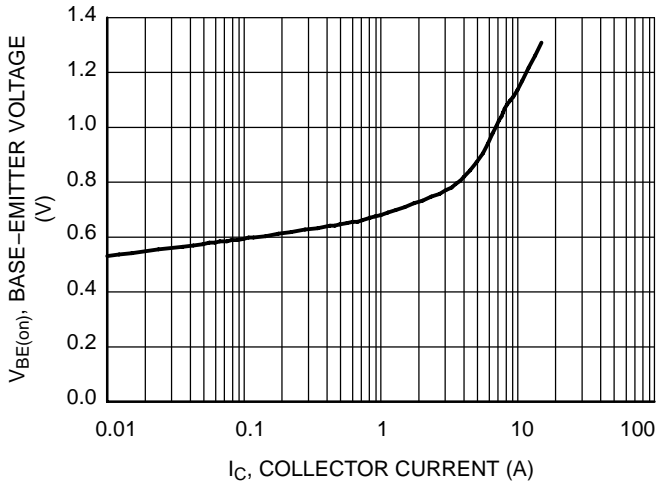
**Figure 5. Typical Saturation Voltage, NPN NJL4281D**



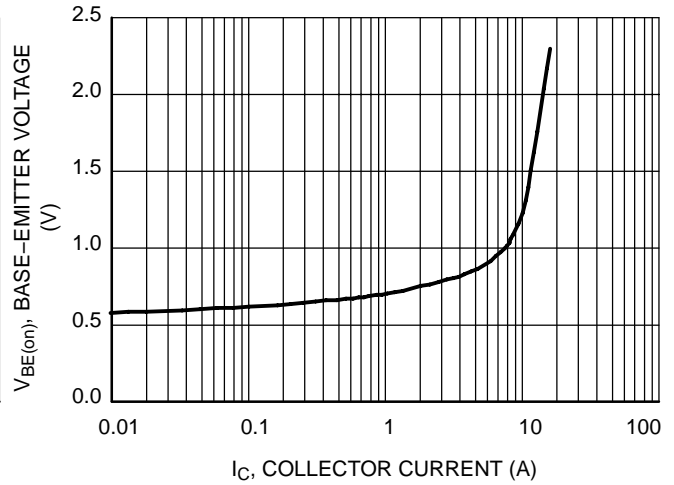
**Figure 6. Typical Saturation Voltage, PNP NJL4302D**

# NJL4281D (NPN) NJL4302D (PNP)

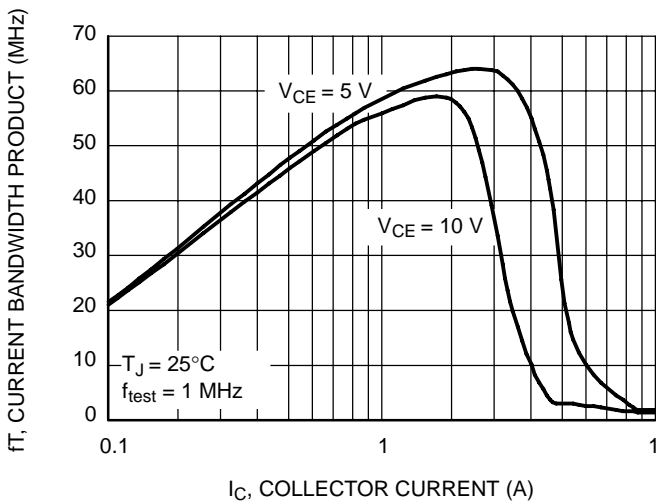
## TYPICAL CHARACTERISTICS



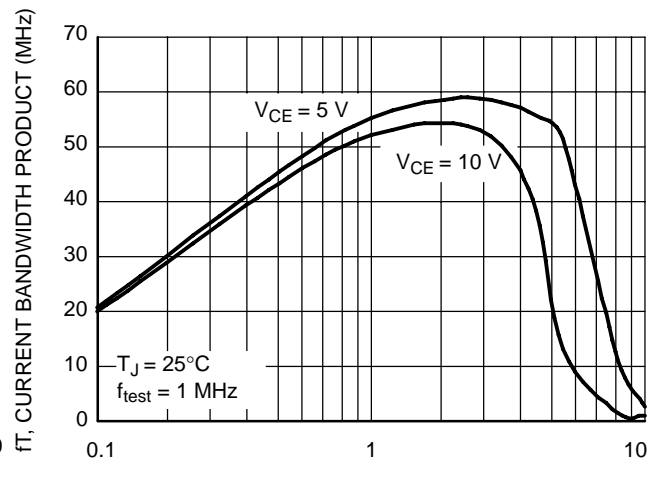
**Figure 7. Typical Base-Emitter Voltages, NPN NJL4281D**



**Figure 8. Typical Base-Emitter Voltages, PNP NJL4302D**

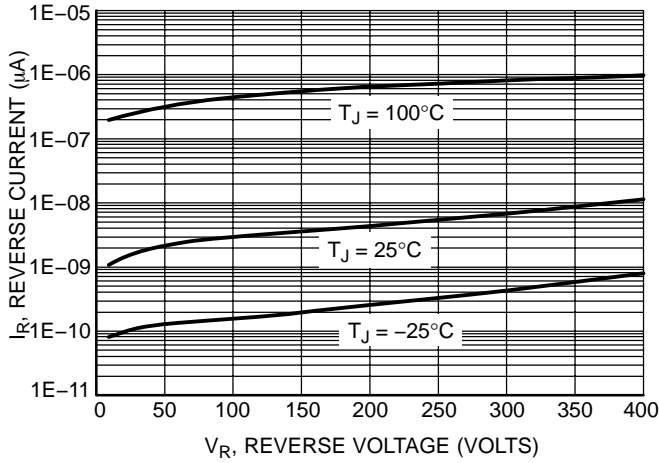


**Figure 9. Typical Current Gain Bandwidth Product, NPN NJL4281D**

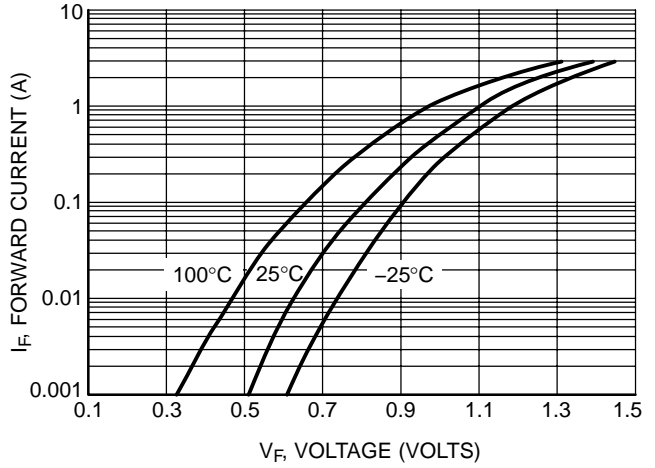


**Figure 10. Typical Current Gain Bandwidth Product, PNP NJL4302D**

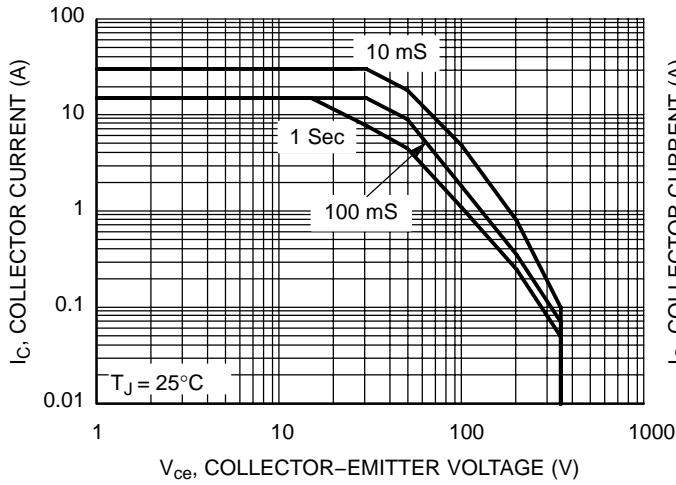
# NJL4281D (NPN) NJL4302D (PNP)



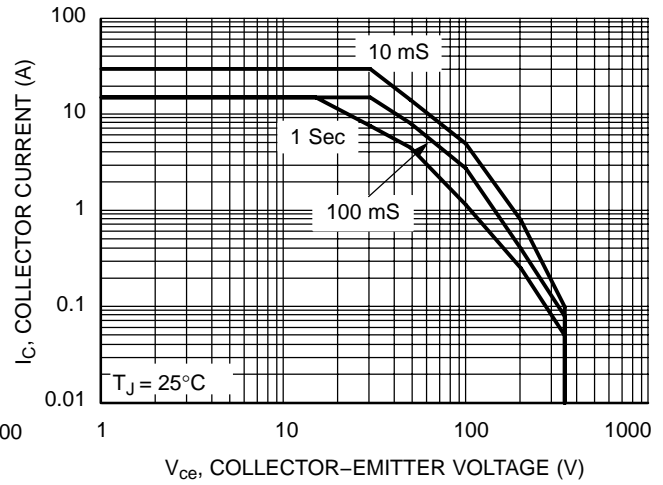
**Figure 11. Typical Diode Reverse Current**



**Figure 12. Typical Diode Forward Voltage**



**Figure 13. Active Region Safe Operating Area, NPN NJL4281D**



**Figure 14. Active Region Safe Operating Area, PNP NJL4302D**

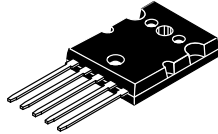
# MECHANICAL CASE OUTLINE PACKAGE DIMENSIONS

ON Semiconductor®

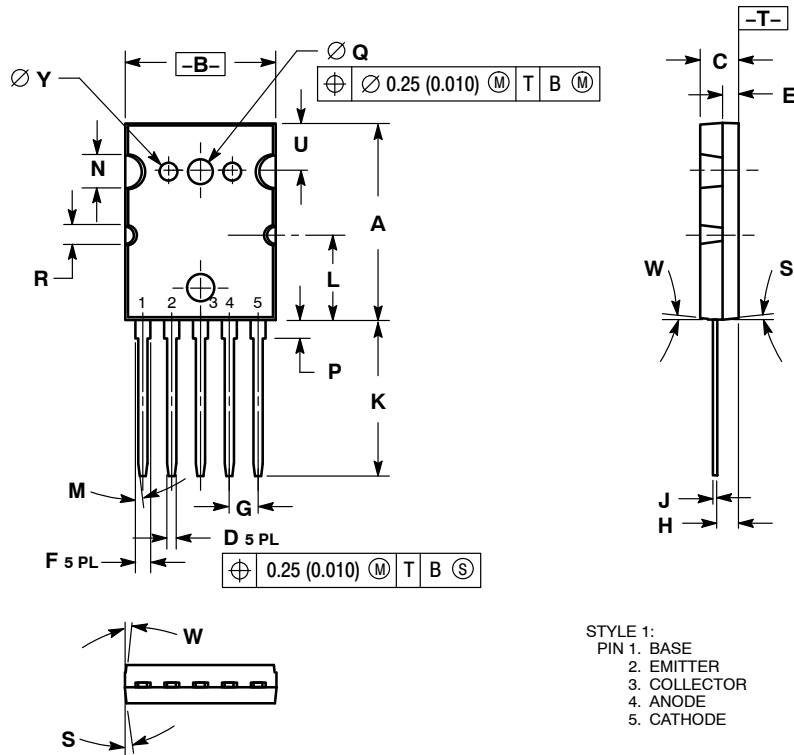


TO-264, 5 LEAD  
CASE 340AA-01  
ISSUE O

DATE 03 FEB 2005



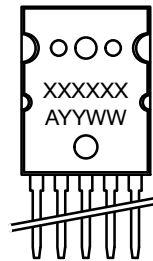
SCALE 1:2



NOTES:  
1. DIMENSIONING AND TOLERANCING PER ANSI Y14.5M, 1982.  
2. CONTROLLING DIMENSION: MILLIMETER.

DIM	MILLIMETERS			INCHES		
	MIN	NOM	MAX	MIN	NOM	MAX
A	25.857	25.984	26.111	1.018	1.023	1.028
B	19.761	19.888	20.015	0.778	0.783	0.788
C	4.699	4.890	5.182	0.185	0.199	0.204
D	1.219 BSC			0.0480 BSC		
E	1.890	2.042	2.184	0.0748	0.0804	0.0860
F	1.981 BSC			0.0780 BSC		
G	3.81 BSC			0.150 BSC		
H	2.667	2.718	2.769	0.1050	0.1070	0.1090
J	0.584 BSC			0.0230 BSC		
K	20.422	20.549	20.676	0.804	0.809	0.814
L	11.28 REF			0.444 REF		
M	0°	---	7°	0°	---	7°
N	4.57 REF			0.180 REF		
P	2.259	2.386	2.513	0.0889	0.0939	0.0989
Q	3.480 BSC			0.1370 BSC		
R	2.54 REF			0.100 REF		
S	0°	---	8°	0°	---	8°
U	6.17 REF			0.243 REF		
W	0°	---	6°	0°	---	6°
Y	2.388 BSC			0.0940 BSC		

### GENERIC MARKING DIAGRAM\*



XXXXXX = Specific Device Code  
A = Assembly Location  
YY = Year  
WW = Work Week  
G or ■ = Pb-Free Package

\*This information is generic. Please refer to device data sheet for actual part marking. Pb-Free indicator, "G" or microdot "■", may or may not be present.

DOCUMENT NUMBER:	98AON19871D	Electronic versions are uncontrolled except when accessed directly from the Document Repository. Printed versions are uncontrolled except when stamped "CONTROLLED COPY" in red.
DESCRIPTION:	TO-264, 5 LEAD	PAGE 1 OF 1

ON Semiconductor and are trademarks of Semiconductor Components Industries, LLC dba ON Semiconductor or its subsidiaries in the United States and/or other countries. ON Semiconductor reserves the right to make changes without further notice to any products herein. ON Semiconductor makes no warranty, representation or guarantee regarding the suitability of its products for any particular purpose, nor does ON Semiconductor assume any liability arising out of the application or use of any product or circuit, and specifically disclaims any and all liability, including without limitation special, consequential or incidental damages. ON Semiconductor does not convey any license under its patent rights nor the rights of others.

**onsemi**, **Onsemi**, and other names, marks, and brands are registered and/or common law trademarks of Semiconductor Components Industries, LLC dba "**onsemi**" or its affiliates and/or subsidiaries in the United States and/or other countries. **onsemi** owns the rights to a number of patents, trademarks, copyrights, trade secrets, and other intellectual property. A listing of **onsemi**'s product/patent coverage may be accessed at [www.onsemi.com/site/pdf/Patent-Marking.pdf](http://www.onsemi.com/site/pdf/Patent-Marking.pdf). **onsemi** reserves the right to make changes at any time to any products or information herein, without notice. The information herein is provided "as-is" and **onsemi** makes no warranty, representation or guarantee regarding the accuracy of the information, product features, availability, functionality, or suitability of its products for any particular purpose, nor does **onsemi** assume any liability arising out of the application or use of any product or circuit, and specifically disclaims any and all liability, including without limitation special, consequential or incidental damages. Buyer is responsible for its products and applications using **onsemi** products, including compliance with all laws, regulations and safety requirements or standards, regardless of any support or applications information provided by **onsemi**. "Typical" parameters which may be provided in **onsemi** data sheets and/or specifications can and do vary in different applications and actual performance may vary over time. All operating parameters, including "Typicals" must be validated for each customer application by customer's technical experts. **onsemi** does not convey any license under any of its intellectual property rights nor the rights of others. **onsemi** products are not designed, intended, or authorized for use as a critical component in life support systems or any FDA Class 3 medical devices or medical devices with a same or similar classification in a foreign jurisdiction or any devices intended for implantation in the human body. Should Buyer purchase or use **onsemi** products for any such unintended or unauthorized application, Buyer shall indemnify and hold **onsemi** and its officers, employees, subsidiaries, affiliates, and distributors harmless against all claims, costs, damages, and expenses, and reasonable attorney fees arising out of, directly or indirectly, any claim of personal injury or death associated with such unintended or unauthorized use, even if such claim alleges that **onsemi** was negligent regarding the design or manufacture of the part. **onsemi** is an Equal Opportunity/Affirmative Action Employer. This literature is subject to all applicable copyright laws and is not for resale in any manner.

## ADDITIONAL INFORMATION

### TECHNICAL PUBLICATIONS:

Technical Library: [www.onsemi.com/design/resources/technical-documentation](http://www.onsemi.com/design/resources/technical-documentation)  
onsemi Website: [www.onsemi.com](http://www.onsemi.com)

### ONLINE SUPPORT: [www.onsemi.com/support](http://www.onsemi.com/support)

For additional information, please contact your local Sales Representative at [www.onsemi.com/support/sales](http://www.onsemi.com/support/sales)