

NSS20201MR6T1G

20 V, 3 A, Low $V_{CE(sat)}$ NPN Transistor

ON Semiconductor's e²PowerEdge family of low $V_{CE(sat)}$ transistors are miniature surface mount devices featuring ultra low saturation voltage ($V_{CE(sat)}$) and high current gain capability. These are designed for use in low voltage, high speed switching applications where affordable efficient energy control is important.

Typical application are DC-DC converters and power management in portable and battery powered products such as cellular and cordless phones, PDAs, computers, printers, digital cameras and MP3 players. Other applications are low voltage motor controls in mass storage products such as disc drives and tape drives. In the automotive industry they can be used in air bag deployment and in the instrument cluster. The high current gain allows e²PowerEdge devices to be driven directly from PMU's control outputs, and the Linear Gain (Beta) makes them ideal components in analog amplifiers.

MAXIMUM RATINGS ($T_A = 25^\circ\text{C}$)

Rating	Symbol	Max	Unit
Collector-Emitter Voltage	V_{CEO}	20	V
Collector-Base Voltage	V_{CBO}	40	V
Emitter-Base Voltage	V_{EBO}	5.0	V
Collector Current – Continuous	I_C	2.0	A
Collector Current – Peak	I_{CM}	3.0	A

THERMAL CHARACTERISTICS

Characteristic	Symbol	Max	Unit
Total Device Dissipation $T_A = 25^\circ\text{C}$ Derate above 25°C	P_D (Note 1)	460 3.7	mW mW/ $^\circ\text{C}$
Thermal Resistance, Junction-to-Ambient	$R_{\theta JA}$ (Note 1)	272	$^\circ\text{C}/\text{W}$
Total Device Dissipation $T_A = 25^\circ\text{C}$ Derate above 25°C	P_D (Note 2)	780 6.3	mW mW/ $^\circ\text{C}$
Thermal Resistance, Junction-to-Ambient	$R_{\theta JA}$ (Note 2)	160	$^\circ\text{C}/\text{W}$
Thermal Resistance, Junction-to-Lead #1	$R_{\theta JL}$ (Note 1) $R_{\theta JL}$ (Note 2)	48 40	$^\circ\text{C}/\text{W}$ $^\circ\text{C}/\text{W}$
Total Device Dissipation (Single Pulse < 10 s)	$P_{D\text{single}}$ (Note 2)	1.5	W
Junction and Storage Temperature Range	T_J, T_{stg}	-55 to +150	$^\circ\text{C}$

Maximum ratings are those values beyond which device damage can occur. Maximum ratings applied to the device are individual stress limit values (not normal operating conditions) and are not valid simultaneously. If these limits are exceeded, device functional operation is not implied, damage may occur and reliability may be affected.

- FR-4 @ 100 mm², 2 oz copper traces.
- FR-4 @ 500 mm², 2 oz copper traces.



ON Semiconductor[®]

<http://onsemi.com>

**20 VOLTS
3.0 AMPS
NPN LOW $V_{CE(sat)}$ TRANSISTOR
EQUIVALENT $R_{DS(on)}$ 100 m Ω**

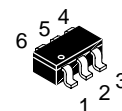
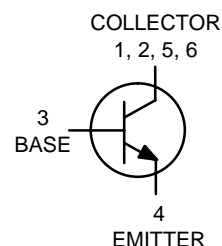

**CASE 318G
TSOP-6
STYLE 6**

DEVICE MARKING

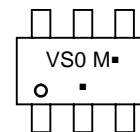

VS0 = Specific Device Code
M = Date Code
■ = Pb-Free Package
(Note: Microdot may be in either location)

ORDERING INFORMATION

Device	Package	Shipping [†]
NSS20201MR6T1G	TSOP-6 (Pb-Free)	3000/Tape & Reel

[†]For information on tape and reel specifications, including part orientation and tape sizes, please refer to our Tape and Reel Packaging Specifications Brochure, BRD8011/D.

NSS20201MR6T1G

ELECTRICAL CHARACTERISTICS (T_A = 25°C unless otherwise noted)

Characteristic	Symbol	Min	Typ	Max	Unit
OFF CHARACTERISTICS					
Collector–Emitter Breakdown Voltage (I _C = 10 mA, I _B = 0)	V _{(BR)CEO}	20	–	–	V
Collector–Base Breakdown Voltage (I _C = 0.1 mA, I _E = 0)	V _{(BR)CBO}	40	–	–	V
Emitter–Base Breakdown Voltage (I _E = 0.1 mA, I _C = 0)	V _{(BR)EBO}	5.0	–	–	V
Collector Cutoff Current (V _{CB} = 40 V, I _E = 0)	I _{CBO}	–	–	0.1	μA
Collector–Emitter Cutoff Current (V _{CES} = 20 V)	I _{CES}	–	–	0.1	μA
Emitter Cutoff Current (V _{EB} = 5.0 V)	I _{EBO}	–	–	0.1	μA
ON CHARACTERISTICS					
DC Current Gain (Note 3) (I _C = 1.0 mA, V _{CE} = 5.0 V) (I _C = 0.5 A, V _{CE} = 5.0 V) (I _C = 1.0 A, V _{CE} = 5.0 V)	h _{FE}	300 300 200	– – –	– – –	
Collector–Emitter Saturation Voltage (Note 3) (I _C = 1.0 A, I _B = 100 mA) (I _C = 0.5 A, I _B = 50 mA) (I _C = 0.1 A, I _B = 10 mA)	V _{CE(sat)}	– – –	– – –	0.150 0.100 0.025	V
Base–Emitter Saturation Voltage (Note 3) (I _C = 1.0 A, I _B = 0.1 A)	V _{BE(sat)}	–	–	0.95	V
Base–Emitter Turn–on Voltage (Note 3) (I _C = 1.0 A, V _{CE} = 2.0 V)	V _{BE(on)}	–	–	0.90	V
Cutoff Frequency (I _C = 100 mA, V _{CE} = 5.0 V, f = 100 MHz)	f _T	200	–	–	MHz
Output Capacitance (f = 1.0 MHz)	C _{obo}	–	–	15	pF

3. Pulsed Condition: Pulse Width ≤ 300 μsec, Duty Cycle ≤ 2%.

MECHANICAL CASE OUTLINE

PACKAGE DIMENSIONS

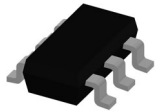

TSOP-6 3.00x1.50x0.90, 0.95P
CASE 318G
ISSUE W

DATE 26 FEB 2024

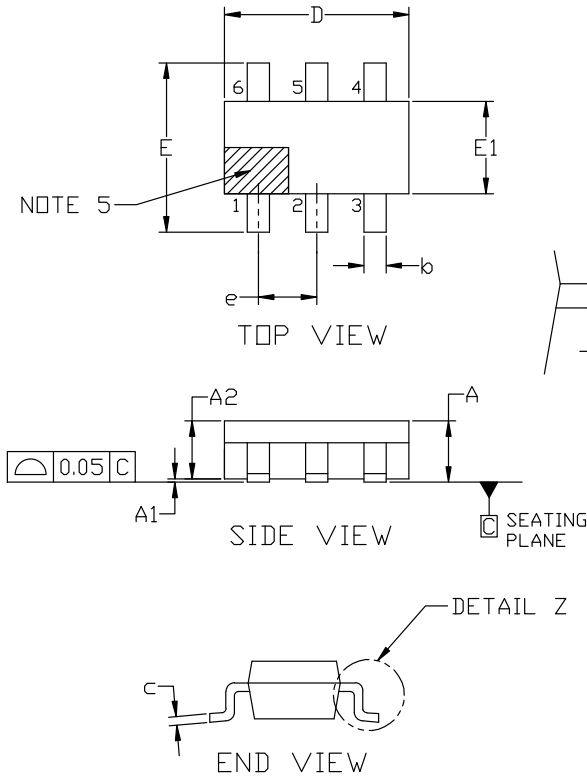

NOTES:

1. DIMENSIONING AND TOLERANCING PER ASME Y14.5M, 2018.
2. CONTROLLING DIMENSION: MILLIMETERS.
3. MAXIMUM LEAD THICKNESS INCLUDES LEAD FINISH. MINIMUM LEAD THICKNESS IS THE MINIMUM THICKNESS OF BASE MATERIAL.
4. DIMENSIONS D AND E1 DO NOT INCLUDE MOLD FLASH, PROTRUSIONS, OR GATE BURRS. MOLD FLASH, PROTRUSIONS, OR GATE BURRS SHALL NOT EXCEED 0.15 PER SIDE. DIMENSIONS D AND E1 ARE DETERMINED AT DATUM H.
5. PIN 1 INDICATOR MUST BE LOCATED IN THE INDICATED ZONE

MILLIMETERS			
DIM	MIN	NOM	MAX
A	0.90	1.00	1.10
A1	0.01	0.06	0.10
A2	0.80	0.90	1.00
b	0.25	0.38	0.50
c	0.10	0.18	0.26
D	2.90	3.00	3.10
E	2.50	2.75	3.00
E1	1.30	1.50	1.70
e	0.85	0.95	1.05
L	0.20	0.40	0.60
L2	0.25 BSC		
M	0°	---	10°

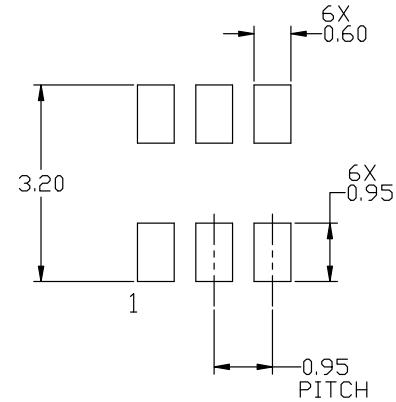
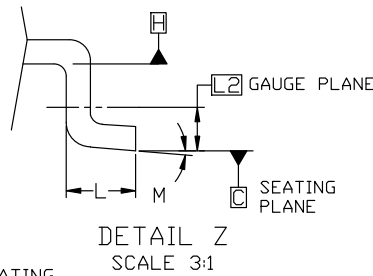

*For additional information on our Pb-Free strategy and soldering details, please download the ON Semiconductor Soldering and Mounting Techniques Reference manual, SOLDERRM/D.

DOCUMENT NUMBER:	98ASB14888C	Electronic versions are uncontrolled except when accessed directly from the Document Repository. Printed versions are uncontrolled except when stamped "CONTROLLED COPY" in red.
DESCRIPTION:	TSOP-6 3.00x1.50x0.90, 0.95P	PAGE 1 OF 2

onsemi and ONSEMI are trademarks of Semiconductor Components Industries, LLC dba onsemi or its subsidiaries in the United States and/or other countries. onsemi reserves the right to make changes without further notice to any products herein. onsemi makes no warranty, representation or guarantee regarding the suitability of its products for any particular purpose, nor does onsemi assume any liability arising out of the application or use of any product or circuit, and specifically disclaims any and all liability, including without limitation special, consequential or incidental damages. onsemi does not convey any license under its patent rights nor the rights of others.

MECHANICAL CASE OUTLINE

PACKAGE DIMENSIONS



TSOP-6 3.00x1.50x0.90, 0.95P
CASE 318G
ISSUE W

DATE 26 FEB 2024

GENERIC MARKING DIAGRAM*

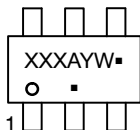

IC

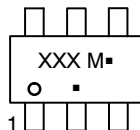

STANDARD

XXX = Specific Device Code
A = Assembly Location
Y = Year
W = Work Week
▪ = Pb-Free Package

XXX = Specific Device Code
M = Date Code
▪ = Pb-Free Package

*This information is generic. Please refer to device data sheet for actual part marking. Pb-Free indicator, "G" or microdot "▪", may or may not be present. Some products may not follow the Generic Marking.

STYLE 1:

- PIN 1. DRAIN
- 2. DRAIN
- 3. GATE
- 4. SOURCE
- 5. DRAIN
- 6. DRAIN

STYLE 2:

- PIN 1. EMITTER 2
- 2. BASE 1
- 3. COLLECTOR 1
- 4. EMITTER 1
- 5. BASE 2
- 6. COLLECTOR 2

STYLE 3:

- PIN 1. ENABLE
- 2. N/C
- 3. R BOOST
- 4. Vz
- 5. V in
- 6. V out

STYLE 4:

- PIN 1. N/C
- 2. V in
- 3. NOT USED
- 4. GROUND
- 5. ENABLE
- 6. LOAD

STYLE 5:

- PIN 1. EMITTER 2
- 2. BASE 2
- 3. COLLECTOR 1
- 4. EMITTER 1
- 5. BASE 1
- 6. COLLECTOR 2

STYLE 6:

- PIN 1. COLLECTOR
- 2. COLLECTOR
- 3. BASE
- 4. EMITTER
- 5. COLLECTOR
- 6. COLLECTOR

STYLE 7:

- PIN 1. COLLECTOR
- 2. COLLECTOR
- 3. BASE
- 4. N/C
- 5. COLLECTOR
- 6. EMITTER

STYLE 8:

- PIN 1. Vbus
- 2. D(in)
- 3. D(in)+
- 4. D(out)+
- 5. D(out)
- 6. GND

STYLE 9:

- PIN 1. LOW VOLTAGE GATE
- 2. DRAIN
- 3. SOURCE
- 4. DRAIN
- 5. DRAIN
- 6. HIGH VOLTAGE GATE

STYLE 10:

- PIN 1. D(OUT)+
- 2. GND
- 3. D(OUT)-
- 4. D(IN)-
- 5. VBUS
- 6. D(IN)+

STYLE 11:

- PIN 1. SOURCE 1
- 2. DRAIN 2
- 3. DRAIN 2
- 4. SOURCE 2
- 5. GATE 1
- 6. DRAIN 1/GATE 2

STYLE 12:

- PIN 1. I/O
- 2. GROUND
- 3. I/O
- 4. I/O
- 5. VCC
- 6. I/O

STYLE 13:

- PIN 1. GATE 1
- 2. SOURCE 2
- 3. GATE 2
- 4. DRAIN 2
- 5. SOURCE 1
- 6. DRAIN 1

STYLE 14:

- PIN 1. ANODE
- 2. SOURCE
- 3. GATE
- 4. CATHODE/DRAIN
- 5. CATHODE/DRAIN
- 6. CATHODE/DRAIN

STYLE 15:

- PIN 1. ANODE
- 2. SOURCE
- 3. GATE
- 4. DRAIN
- 5. N/C
- 6. CATHODE

STYLE 16:

- PIN 1. ANODE/CATHODE
- 2. BASE
- 3. EMITTER
- 4. COLLECTOR
- 5. ANODE
- 6. CATHODE

STYLE 17:

- PIN 1. EMITTER
- 2. BASE
- 3. ANODE/CATHODE
- 4. ANODE
- 5. CATHODE
- 6. COLLECTOR

DOCUMENT NUMBER:	98ASB14888C	Electronic versions are uncontrolled except when accessed directly from the Document Repository. Printed versions are uncontrolled except when stamped "CONTROLLED COPY" in red.
DESCRIPTION:	TSOP-6 3.00x1.50x0.90, 0.95P	PAGE 2 OF 2

onsemi and ONSEMI are trademarks of Semiconductor Components Industries, LLC dba onsemi or its subsidiaries in the United States and/or other countries. onsemi reserves the right to make changes without further notice to any products herein. onsemi makes no warranty, representation or guarantee regarding the suitability of its products for any particular purpose, nor does onsemi assume any liability arising out of the application or use of any product or circuit, and specifically disclaims any and all liability, including without limitation special, consequential or incidental damages. onsemi does not convey any license under its patent rights nor the rights of others.

onsemi, **Onsemi**, and other names, marks, and brands are registered and/or common law trademarks of Semiconductor Components Industries, LLC dba "**onsemi**" or its affiliates and/or subsidiaries in the United States and/or other countries. **onsemi** owns the rights to a number of patents, trademarks, copyrights, trade secrets, and other intellectual property. A listing of **onsemi**'s product/patent coverage may be accessed at www.onsemi.com/site/pdf/Patent-Marking.pdf. **onsemi** reserves the right to make changes at any time to any products or information herein, without notice. The information herein is provided "as-is" and **onsemi** makes no warranty, representation or guarantee regarding the accuracy of the information, product features, availability, functionality, or suitability of its products for any particular purpose, nor does **onsemi** assume any liability arising out of the application or use of any product or circuit, and specifically disclaims any and all liability, including without limitation special, consequential or incidental damages. Buyer is responsible for its products and applications using **onsemi** products, including compliance with all laws, regulations and safety requirements or standards, regardless of any support or applications information provided by **onsemi**. "Typical" parameters which may be provided in **onsemi** data sheets and/or specifications can and do vary in different applications and actual performance may vary over time. All operating parameters, including "Typicals" must be validated for each customer application by customer's technical experts. **onsemi** does not convey any license under any of its intellectual property rights nor the rights of others. **onsemi** products are not designed, intended, or authorized for use as a critical component in life support systems or any FDA Class 3 medical devices or medical devices with a same or similar classification in a foreign jurisdiction or any devices intended for implantation in the human body. Should Buyer purchase or use **onsemi** products for any such unintended or unauthorized application, Buyer shall indemnify and hold **onsemi** and its officers, employees, subsidiaries, affiliates, and distributors harmless against all claims, costs, damages, and expenses, and reasonable attorney fees arising out of, directly or indirectly, any claim of personal injury or death associated with such unintended or unauthorized use, even if such claim alleges that **onsemi** was negligent regarding the design or manufacture of the part. **onsemi** is an Equal Opportunity/Affirmative Action Employer. This literature is subject to all applicable copyright laws and is not for resale in any manner.

ADDITIONAL INFORMATION

TECHNICAL PUBLICATIONS:

Technical Library: www.onsemi.com/design/resources/technical-documentation
onsemi Website: www.onsemi.com

ONLINE SUPPORT: www.onsemi.com/support

For additional information, please contact your local Sales Representative at www.onsemi.com/support/sales